

**MANUAL  
OF REFORESTATION  
AND  
EROSION CONTROL  
FOR THE PHILIPPINES**

**gtz**

Schriftenreihe der Deutschen Gesellschaft  
für Technische Zusammenarbeit (GTZ) GmbH

III H 14c

77-1355

**MANUAL  
OF REFORESTATION  
AND EROSION CONTROL  
FOR THE PHILIPPINES**

**BY**

**A. AGPADA, D. ENDANGAN, S. FESTIN  
J. GUMAYAGAY, TH. HOENNINGER,  
G. SEEBER, K. UNKEL, H.J. WEIDELT**



---

**COMPILED BY H.J. WEIDELT**

---

Eschborn 1975

Titel - Nr. 77-1355

PUBLISHED AUGUST 1975 BY GERMAN AGENCY FOR TECHNICAL COOPERATION, LTD. (GTZ)  
D-6236 ESCHBORN 1, STUTTGARTER STRASSE 10, W.-GERMANY  
ISBN 3-88085-020-8  
TYPO-DRUCK-ROSSDORF, 6101 ROSSDORF/DARMSTADT

## Foreword

Centuries of misuse for lack of knowledge on the proper conservation of our forest resources has led to the denudation of over five million hectares of our forest lands causing severe erosions. These are mostly located in critical watershed areas of our principal rivers, thus, making reforestation and erosion control of utmost importance.

The training in reforestation and erosion control in our country is therefore, timely and relevant to the current national development program launched under the leadership of President Ferdinand E. Marcos. This program has become a major project of our government and it has to succeed if we want to achieve national progress.

This MANUAL ON REFORESTATION AND EROSION CONTROL for the Philippines, the first of its kind ever published, will serve as a guide and a valuable reference for foresters and for those engaged in reforestation and erosion control in the country. It is the product of the joint efforts and cooperation between the Philippine counterparts and the German consultants sent by the German Agency for Technical Cooperation (GTZ):

The book itself, is by no means complete but definitely is an answer to the lack of reference books well adopted to Philippine conditions and serves as a monument to the most productive relationship between the German Agency for Technical Cooperation (GTZ) and the government of the Republic of the Philippines through its Bureau of Forest Development.



JOSE VIADO  
Acting Director  
Bureau of Forest Development



C O N T E N T S

Page

Foreword

Preface of the Authors

PART I

INTRODUCTION TO PHILIPPINE FORESTRY

Th. Hoenninger

1. Geographical Situation	
1.1 General remarks .....	3
1.2 Luzon .....	4
1.3 Visayan Islands .....	5
1.4 Mindanao and Sulu Islands .....	6
2. Philippine Soils	
2.1 General remarks .....	8
2.2 Alluvial deposits .....	9
2.3 Soils originating from shales and sandstone .....	9
2.4 Volcanic tuff .....	10
2.5 Soils derived from andesite, basalts, and agglomerates .....	10
2.6 Limestone soils .....	11
3. Climatic Conditions	
3.1 The rainfall pattern .....	12
3.2 Variations of rainfall .....	13
3.3 Climatic types .....	14
3.4 Temperature variations .....	15
3.5 Typhoons or tropical cyclones .....	15

	Page
4. Natural Forest Types .....	18
4.1 Dipterocarp forests .....	19
4.2 Molave forest .....	21
4.3 Mangrove forests .....	22
4.4 Beach forest .....	22
4.5 Pine forest .....	23
4.6 Mossy forest .....	23
5. Management of Natural Forests	
5.1 Selective logging in dipterocarp forests .....	25
5.2 Management of pine forests under the Tree Seed Method .....	27
6. Reforestation .....	28
References .....	33

## PART II

### ESTABLISHMENT, MAINTENANCE AND PROTECTION OF FOREST PLANTATIONS

H. J. Weidelt

1. Planting Survey, Planting Plan, Plantation Records and Maps	
1.1 The planting survey .....	37
1.2 The planting plan .....	38
1.3 Plantation records .....	40
1.4 Plantation maps .....	41
2. Ecological Aspects for the Choice of Tree Species	
2.1 Climatic factors .....	43
2.2 The edaphic factors .....	46
3. Ecological Notes on Some Reforestation Species .....	51
4. The Objectives of Reforestation and the Choice of Tree Species .....	63
4.1 Production of sawnwood .....	64
4.2 Production of pulpwood .....	65
4.3 Production of fuelwood .....	67
4.4 Poles and piles for local consumption .....	68
4.5 Production of "minor" forest products .....	70
4.6 Planting for erosion control .....	72
4.7 Protection and improvement of watersheds .....	72
4.8 Shelterbelts .....	73
4.9 Tree planting for beautification .....	75

	Page
5. Mixed and Pure Plantations	
5.1 Arguments in favor of mixed plantations .....	78
5.2 Arguments in favor of pure plantations .....	79
5.3 Types of mixtures .....	80
6. Spacing of Forest Plantations .....	82
6.1 Aspects to be considered in spacing .....	83
6.2 Recommended spacing for some reforestation species .....	84
7. Supervision and Timing of Reforestation Work	
7.1 Supervision .....	87
7.2 Timing of plantation work .....	90
8. Site Preparation for Field Planting	
8.1 Site preparation by complete removal of the vegetation .....	92
8.2 Site preparation by partial removal of the vegetation .....	93
9. General Considerations on Tree Planting Techniques	
9.1 Quality and size of planting stock .....	96
9.2 Size of planting holes .....	97
9.3 Depth of rooting horizon .....	97
9.4 Protection of roots during planting .....	98
9.5 Correct planting depth .....	98
10. Tree Planting Techniques and Tools	
10.1 Planting of potted seedlings .....	100
10.2 Planting of bare root seedlings .....	104
10.3 Stump planting .....	109
11. Planting of Wildlings .....	111
12. Direct Seeding .....	113
13. Replacement of Failures .....	116
14. Reforestation on Adverse Sites	
14.1 Dry sites and adverse southern exposure .....	118
14.2 Rocky sites .....	120
14.3 Coastal sands .....	120
14.4 Swampy sites .....	121
14.5 Steep slopes .....	121
14.6 Planting in high grass .....	122
15. Taungya Plantations, a Possible Solution of the Kaingin Problem	
15.1 Forms of the taungya system .....	123
15.2 Conditions for successful taungya .....	124
15.3 The taungya agreement .....	125
15.4 Some common agricultural crops suitable for taungya planting .....	127
15.5 Planning and organization of taungya projects ..	129

	Page
16. Improvement of Overlogged Areas by Enrichment Planting	
16.1 Methods of enrichment planting .....	130
16.2 Planting stock and suitable species .....	133
16.3 Tending operations .....	134
16.4 The cost of line enrichment .....	134
16.5 Advantages and disadvantages of line enrichment ..	135
17. Some Practical Guidelines for Fertilizer Application in Young Plantations	
17.1 The role of the main plant nutrients and their sources .....	136
17.2 Type of fertilizer .....	137
17.3 Method of application .....	138
17.4 Quantity to be applied .....	139
17.5 Indications for fertilizer application in plantations .....	140
18. The Control of Weeds, Climbers and Undesirable Trees	
18.1 Weed control .....	141
18.2 Climber cutting .....	145
18.3 Removal of undesirable trees .....	146
19. Pruning as a Measure of Stand Improvement .....	148
19.1 The process of natural pruning .....	149
19.2 Artificial pruning in conifer plantations .....	150
19.3 Correction of growth forms in hardwood plantations	153
20. The Basic Principles of Thinning Plantations	
20.1 Thinning of young stands .....	158
20.2 Thinning of older plantations .....	159
20.3 Numerical guides for thinning .....	160
20.4 The relation between thinning intensity, volume production and financial return .....	162
21. Forest Fire Control	
21.1 Fire causes .....	165
21.2 The development and behavior of a forest fire ..	166
21.3 Preventive measures .....	169
21.4 Fire detection .....	171
21.5 Organization of fire control .....	172
21.6 Fire suppression .....	173
21.7 Equipment for fire fighting .....	176
22. Prevention of Fungus Diseases in Forest Plantations ..	177
23. Prevention of Insect Calamities	
23.1 Common insect pests in forest plantations .....	181
23.2 Natural control factors against insect calamities.	189
24. Rodent Control in Plantations .....	193
24.1 Poisoning .....	194
24.2 Repellents .....	195
24.3 Other protective measures .....	195

	Page
25. Conflicts Between Forestry and Cattle Ranching	
25.1 Aspects of damage by cattle ranching .....	196
25.2 Possible solutions .....	198
References .....	199

### PART III

#### ELEMENTARY COMPASS SURVEYING AND MAPPING

J. Gumayagay and S. Festin

1. Compass Surveying and Recording of Field Data .....	207
2. Mapping Scale, Plotting of Field Notes and Tracing the Sketch .....	
2.1 The map scale .....	218
2.2 Plotting of field notes .....	218
2.3 Tracing the sketch .....	221
3. The Close Traverse	
3.1 The sketch with technical description .....	222
3.2 Correcting error of closure .....	224
3.3 Area determination of a close traverse .....	227
Appendix: Conventional abbreviations used in field sketches .....	228

### PART IV

#### NURSERY TECHNIQUES

G. Seeber

1. Nursery Establishment and Layout	
1.1 Types of forest nurseries .....	231
1.2 Selection of nursery site .....	232
1.3 Preparation and layout of the nursery area .....	235
1.4 Fencing the nursery site .....	238
1.5 Buildings and similar facilities .....	240
1.6 Tools and materials .....	241
2. Installation of the Irrigation System	
2.1 Consideration about water quantity .....	242
2.2 Water sources .....	243
2.3 Types of pumps .....	245
2.4 Conveyance and distribution of irrigation water ..	247

	Page
3. Sowing .....	249
3.1 The correct sowing time .....	250
3.2 Preparation of seedbeds .....	251
3.3 Preparation of seedboxes and greenhouse benches .....	254
3.4 Sowing techniques .....	256
4. Production of Nursery Plants by Cuttings .....	262
4.1 Suitable species .....	263
4.2 Propagation beds .....	263
4.3 Sources of cuttings .....	264
4.4 Preparation of cuttings .....	265
4.5 Treatments to promote root formation .....	266
4.6 Planting of cuttings .....	266
4.7 Care of cuttings during the rooting process .....	267
4.8 Potting of the young offspring plant .....	267
5. Transplanting in Open Beds	
5.1 Preparation of seedlings .....	268
5.2 Transplanting tools and techniques .....	269
6. Raising of Container Plants (Potting)	
6.1 Types of containers .....	273
6.2 Potting soil .....	277
6.3 Potting techniques .....	280
7. Care and Maintenance of Seedlings	
7.1 Watering .....	283
7.2 Mulching .....	288
7.3 Shading .....	290
7.4 Protection from strong rains .....	296
7.5 Weed control .....	297
7.6 Root pruning .....	302
7.7 Hardening-off .....	305
8. Preparation of Planting Stock for Field Planting	
8.1 Culling and grading of nursery plants .....	307
8.2 Bare root seedlings .....	309
8.3 Stumps .....	313
8.4 Earthballed plants .....	314
8.5 Potted plants .....	315
9. Soil - its Characteristics and Proper Management in the Forest Nursery	
9.1 Mineral soil particles .....	316
9.2 Texture classes .....	317
9.3 Soil structure and pore space .....	318
9.4 Humus .....	319
9.5 Soil organisms .....	320
9.6 Soil reaction .....	322
9.7 The role of plant nutrients and deficiency symptoms .....	325

	Page
9.8 Commercial fertilizers .....	328
9.9 Preparation of compost .....	333
9.10 Green manuring .....	336
10. Prevention and Control of Pests and Diseases	
10.1 Introduction .....	338
10.2 Methods of plant protection .....	339
10.3 Preventive measures .....	341
10.4 Names, terms and groups of pesticides .....	344
10.5 Application of pesticides	
5.1 Seed treatment .....	346
5.2 Soil fumigation .....	347
5.3 Soil drenching .....	347
5.4 Spraying .....	348
5.5 Application of dusts and granules .....	354
10.6 Precautions when Handling Pesticides .....	356
10.7 Steam Sterilization of Soil .....	359
10.8 Some Common Pests and Diseases	
8.1 Diseases .....	361
8.2 Nematodes .....	364
8.3 Mites .....	365
8.4 Insects .....	366
8.5 Snails and slugs .....	372
8.6 Rodents - rats and mice .....	373
8.7 Birds .....	374
Appendix I : Addresses of important producer and supplier firms for agricultural chemicals .....	375
Appendix II : List of some common pesticides available in the Philippines .....	376
Appendix III: Some useful conversion factors and equivalents for pesticide application .....	385
References .....	387

## PART V

### EROSION CONTROL

K. Unkel and D. Endangan

1. Kinds of Erosion	
1.1 Erosion by natural forces and human interference .....	393
1.2 Wind erosion .....	394
1.3 Gravity erosion .....	394
1.4 Water erosion .....	395

	Page
9. Vegetative Methods of Slope Stabilization	
9.1 Planting and Sowing	435
9.2 Brush cover (German: "Spreitlage")	436
9.3 Bench brush layers (French: "Cordon", German: "Buschlage")	441
9.4 Wattling	446
9.5 Slope stabilization with fascines	449
9.6 Sodding	452
9.7 Mulching and bitumen emulsion	453
9.8 Slope stabilization by hydro-seeding	455
10. Solid Retaining Walls and Combined Methods of Slope Stabilization	456
10.1 Riprap or dry stone walls	457
10.2 Retaining walls of concrete or masonry	457
10.3 Gabions for slope stabilization	458
10.4 Riprap interplanted with cuttings	459
10.5 Pole structure (German: "Krainierwand")	459
10.6 Slope stabilization with worn-out tires	460
11. Gully Stabilization	
11.1 Improvement of the catchment area	462
11.2 Stabilization of the gully head	463
11.3 Stabilization of gullies belonging to the natural drainage system	465
11.4 Reclamation of gullies not belonging to the natural drainage system	470
12. Control of Riverbank Erosion	473
12.1 Temporary and emergency measures	474
12.2 Methods depending mainly on sprouting brushwood	476
12.3 Riverbank stabilization by planting	483
12.4 Solid structures	484
13. Shelterbelts, their Function and Layout	487
Appendix I: Expression of gradient	490
References	491

## PART VI

### FOREST TREE SEED

G. Seeber and A. Agpaoa

1. Sources of Forest Tree Seed	
1.1 Introduction	495
1.2 Seed certification	496
1.3 Seed origin	498

	Page
2. Factors Affecting Erosion	
2.1 Rainfall characteristics	400
2.2 Topographic characteristics of the watershed	401
2.3 Physical soil properties	403
2.4 Chemical soil properties	405
3. Human Interference as the Main Cause of Erosion	
3.1 Logging and fuelwood cutting	407
3.2 Kaingin making	408
3.3 Forest fires and grassland burning	408
3.4 Improper range management	409
3.5 Road cuts	410
3.6 Improper disposal of mining waste	410
3.7 Improper drainage	410
4. The Effects of Erosion	
4.1 Deterioration of farm land	411
4.2 Increase of floods	411
4.3 Reduced water supplies	412
4.4 Silting-up of reservoirs, canals and rivers	412
4.5 Destruction of buildings, roads and other communication lines	412
5. Preventive Measures Against Erosion	413
5.1 Educational campaigns	414
5.2 Fire prevention and control	414
5.3 Fencing	414
5.4 Proper land use	414
5.5 Proper range management	415
5.6 Restrictions on kaingin making	416
5.7 Restrictions on logging in critical areas	417
5.8 Proper road construction and maintenance	418
6. Elements of Engineering Structures	
6.1 Masonry	419
6.2 Concrete	419
6.3 Gabions	420
7. Plants and Other Materials for Biological Engineering	
7.1 Plants for soil stabilization	424
7.2 Preparation of cuttings	427
7.3 Grass sods	428
7.4 Bitumen emulsion	428
7.5 Anchoring pegs	429
8. Preparation of Slope Stabilization Sites and Layout of Drainage	
8.1 Preparations	430
8.2 Drainage	431

	Page
2. Seed Collection	
2.1 Timing of seed collection .....	503
2.2 How to judge the maturity and quality of the fruit .....	504
2.3 Tools for seed collection .....	506
2.4 Methods of seed collection .....	507
3. Extraction of Seed	
3.1 Seeds which are sown as a fruit itself .....	509
3.2 Fruits which open when dry .....	509
3.3 Pods which do not open easily .....	510
3.4 Pine cones .....	510
3.5 Treatment of small fleshy fruits .....	511
3.6 Treatment of large fleshy fruits .....	511
3.7 Extraction of kaatoan bangkal seed .....	511
4. Storage of Seed	
4.1 Longevity of seed .....	512
4.2 Atmospheric factors affecting seed storage .....	513
4.3 Methods of seed storage .....	515
5. Shipment of Seed	
5.1 Packing of dry seeds .....	517
5.2 Moist seed packing .....	517
6. Protection of Seeds From Rodents and Insects	
6.1 Rodents .....	518
6.2 Insects .....	519
7. Treatments to Hasten Germination .....	520
7.1 Cold water treatment .....	521
7.2 Alternating soaking and drying .....	521
7.3 Hot water treatment .....	521
7.4 Chemical treatments .....	521
7.5 Scarification .....	522
7.6 Nicking and similar methods .....	522
7.7 Complete removal of the seed coat .....	523
7.8 Burying of seed in the ground .....	523
7.9 "White ant" treatment of teak seed .....	523
7.10 "Fire treatment" .....	524
8. Quality Assessment of Tree Seed and Germination Tests ..	524
8.1 Size and weight of seed .....	525
8.2 Determination of purity .....	525
8.3 Determination of viability .....	526
9. The Tree Percent and Estimates of Seed Requirements ..	530
Appendix: Seed size and seed weight of some forest trees ..	532
References .....	534

PART VII  
INDEX TO COMMON AND SCIENTIFIC NAMES

a) Index to Common Names .....	539
b) Index to Scientific Names .....	547

PART VIII  
SUBJECT INDEX

## PREFACE OF THE AUTHORS

The layout of this book originates from lectures held by the authors during a six years training programme at the PHILIPPINE-GERMAN TRAINING CENTER FOR REFORESTATION AND EROSION CONTROL at Baguio City sponsored under the Technical Assistance Programme of the Federal Republic of Germany.

The training programme had been designed as a refresher course for the field personnel of the BUREAU OF FOREST DEVELOPMENT, mainly on the ranger level, and emphasis was more on the practical side.

Special effort was made to adapt useful procedures developed in temperate countries to tropical and especially Philippine conditions. As a result we feel, that the procedures described in this book may also be of interest to foresters of other tropical countries with related problems.

The authors have to acknowledge gratefully the cooperation of Mr. Herminio Boado who typed the final draft of this book in a non-stop effort and the patience of Mr. Conrado Consul and Mr. Julius Unciano in the preparation of the numerous illustrations.

THE AUTHORS

P A R T I

INTRODUCTION TO PHILIPPINE FORESTRY

TH. HOENNINGER



Chapter 1:

GEOGRAPHICAL SITUATION

1.1 General Remarks

The entire Pacific Basin from Kamchatka south to Japan, Taiwan, the Philippines, Indonesia and on through New Zealand owes much of its development to a vast and exceedingly complex series of stress lines, along which faulting, folding, and volcanic and earthquake activity have taken place.

The most important fault line lies across North Central Luzon. It crosses the Bicol Peninsula, continues southward through the mountains of Eastern Mindanao. A belt paralleling this fault line is marked by many of the highest elevations in the Philippines as well as by numerous active volcanoes. A less pronounced fault line runs from SW to NE connecting Borneo and SW Luzon through the 400 km long island of Palawan. Still another reaches from Northeast Borneo through the Sulu Islands into the tail-like Zamboanga Peninsula.

Much of the present day pattern of island distribution and of local mountain building has resulted from the fact, that the Philippines is situated in a zone of convergence of several Pacific mountain building zones. Pronounced recent movement along these lines is demonstrated by the limestone consisting of coral, which is now lying at considerable elevations on numerous islands in such diverse locations as Palawan, Mindanao, Cebu and Northern Luzon.

The archipelago consists of 7,100 islands, of which only 2,773 have names. The northernmost point, Y'Ann Isle is situated

125 km from Taiwan, the southernmost point, Saluag Island is only 55 km from Borneo. The total land area of the Philippines is 300,000 square kilometers. The irregular coastline stretches 17,400 km, twice as long as the coastline of the United States of America.

Luzon, the largest island, is larger than Portugal. Mindanao, the second largest island, is larger than Austria, and Samar, the third largest island, exceeds the size of Cyprus.

The highest mountain of the Philippines is Mt. Apo (2955 m) in Mindanao. The lowest spot in the world is the "Philippine Depth", situated east of Mindanao. It is 11,500 meters deep, and the Mt. Everest, the highest Mountain of the world, could easily be submerged in it.

## 1.2 Luzon

The mountain ranges of Central and Northern Luzon form the outline of an upright "Y" with an outlier parallel to the main arm of the Y on the west coast, the Zambales Mountains. Along the east coast the mountains border directly the Pacific Ocean and leave only small patches of level land consisting mostly of Tertiary and Quarternary sediments. The mountains collectively known as Sierra Madre extend with only one break (southwest of Baler) from the Quezon Memorial park in the south to Cape Engaño in the extreme northeast.

Situated parallel to the west coast of northern Luzon are the mountains of the Cordillera Central, while their western outliers are known as the Ilocos Mountains. The Cordillera like the Sierra Madre has a core composed mainly of basic rock types of the Mesozoic period. However, a significant portion of the middle section consists of Tertiary volcanic formations.

North of Luzon are the Babuyan and Batanes Islands. Here a complex mixture of volcanic activity and reef building has created an environment as forbidding and fascinating as any in the Archipelago.

In the Zambales Mountains, the central and northern portions are composed of complex Mesozoic formations, while the southern and highest portions consist of Tertiary volcanic material. In addition to acting as a transportation barrier, these mountains lie directly athwart the southwest monsoon and intercept considerable rainfall. Consequently there are heavy dipterocarp forests on the windward slopes and more open forests on the lee slopes.

Plains of Central and Northern Luzon. The Central Plain of Luzon east of the Zambales Mountains extends unbroken from Laguna de Bay to the Lingayen Gulf. It has once been occupied by the sea, and is now covered by marine sediments. The surface cover consists mainly of volcanic tuff. From this flat of Quarternary deposits extinct volcanoes rise abruptly resembling inselbergs. Mount Arayat is the highest and rises in a beautifully symmetrical cone. A second large plain is found between the Sierra Madre and the Cordillera Central, the Cagayan Valley. Its rolling surface suggests that erosion played a part in its origin.

Southern Luzon is composed of a complex series of peninsulas marked by many fault lines and numerous exposures of ultrabasic basement rocks. Between the six still active and numerous dormant volcanoes are spread broad areas of almost level Tertiary and Quarternary volcanic deposits which have resulted in very fertile soils. In this region Mt. Mayon is probably the most symmetrical and beautiful volcano in the world.

## 1.3 Visayan Islands.

The southeast trend of the Bicol Peninsula continues throughout the islands of Samar and Leyte. The other large islands, however, like Cebu, Negros, Panay and Palawan show trend lines towards the southwest.

Mindoros backbone is a broad anticlinal ridge of Mesozoic rock with mountains rising up to 2500 meters. Samar shows a mature hilly landscape with little really flat land on the

hill tops or the valley bottoms. Leyte is separated from Samar by the narrow San Juanico Strait and bisected by the main Philippine fault line. Cebu has large areas of steep slopes and severe erosion, yet it is one of the most densely populated islands. Massive beds of Tertiary limestone are exposed at the surface and many features of a carst topography, such as sink holes and underground stream channels, are present. Negros, the fourth largest island, is dominated by four volcanic mountains. From their eruptions fertile plains have built up. In Bohol Tertiary and Quaternary limestone and coral with carst features abound. Underground drainage give the island a much more arid appearance than the rainfall data would suggest. In Panay the folded mountains of Mesozoic basement rock along the boundary of Antique act as an effective wooded barrier for rainfall and transportation to the well populated agricultural plain in the east.

The elongated island of Palawan is forming a bridge between the Philippine Archipelago and Borneo. That a land connection between the two islands has existed in the past is indicated by the fact, that flora, fauna and fossil remains from Palawan are more closely related to those from Borneo than to those from other islands in the Philippines.

#### 1.4 Mindanao and Sulu Islands.

Mindanao, the second largest island of the Philippines shows the greatest variety of physiographic development. In this island one can find high, rugged, faulted mountains, almost isolated volcanic peaks, high rolling plateaus, and broad, level, swampy plains.

The mountains of Mindanao can conveniently be grouped into five ranges, which enclose nine active volcanoes. Parallel to the remote and forbidding east coast from Surigao del Norte to Cape Augustin is one range of mountains. A second range extends in north-south direction west of the Agusan River from the Camiguin Island volcano to Tinaca Point with two other active volcanoes, one of them Mt. Apo. A third

range of complex mountains with six active volcanoes is found southeast of the Lanao Lake. Finally a fourth range of volcanic mountains runs parallel to the coast of South Cotabato.

Another important geographical feature of Mindanao is the series of upland plateaus in Bukidnon and Lanao del Sur. These plateaus are composed of basaltic lava flows interbedded with ash and volcanic tuff. Near their edges at several points spectacular waterfalls (Maria Christina, Abad Santos) drop the the narrow coastal plain.

Mindanao has two large plains situated in the valleys of the Agusan River and the Mindanao River in Cotabato Province. The latter is in full agricultural development and may compete with Central Luzon.

The Basilan and Sulu Islands extend over 300 kilometers and form a natural series of stepping stones between Borneo and Mindanao. Probably during the Pleistocene these islands, too, formed a land bridge across which man as well as animals and plants moved to the Philippines. The hilly interior portions of these islands are mainly of volcanic origin, the coastal areas composed of uplifted coral limestone.

This brief account of the geographical situation of the Philippines has been adapted from the works of CHOINSKI (1967), FISHER (1967), ROBEQUAIN (1964) and ZAIDE (1970).

PHILIPPINE SOILS2.1 General remarks

Soil formation results from the action of climate, natural vegetation and soil organisms upon a diversity of parent materials. Where land has been stable over long geological periods, the soils tend to lose the character of their parent material and assume the characteristics of their environment. Where soils are youthful, as in the case of most Philippine soils, they tend to show strong influences of their geological parentage. Therefore the parent material may serve as a basis for soil classification, until more complete and detailed information becomes available (Table 1).

Parent material	Area	Percent of total area
Alluvial deposits	4.5 mil. ha	15
Shale and sandstone	4.4 mil. ha	15
Volcanic tuff	0.6 mil. ha	2
Andesite, basalt, agglomerates	6.2 mil. ha	21
Limestone	3.8 mil. ha	13
Complex	4.1 mil. ha	14
Rough mountain soils	5.6 mil. ha	19
Unsurveyed	0.4 mil. ha	1

Table 1: Parent material of Philippine soils )Source: BUREAU OF SOILS, MANILA)

2.2 Alluvial deposits

All the fertile plains in the Philippines consist of alluvial deposits and are heavily populated. The fine textured alluvial soils like clay loams and clay are generally utilized for irrigated rice. The main areas are situated in Central Luzon, the Cagayan Valley and the flats of the Mindanao River.

Alluvial soils of coarse texture are used for sugar-cane, maize, abacca, coconut and tobacco. These soils have a very good permeability, but are usually of low fertility because of rapid leaching. This type of soil is found in Tarlac and Pampanga, Negros and Cotabato.

There are also limited areas with alkaline soils usually with a poor drainage. In Cotabato cotton and sorghum is grown on these soils.

2.3 Soils originating from shales and sandstone

In the Philippines soils originating from shales are more common than those from sandstone. Their color usually is black or dark brown and in most cases they have to be classified as clays. When wet these soils are plastic or sticky, in dry condition they become hard and crack.

The profile depth depends largely on the hardness of the parent material. The surface often shows a rolling relief. The permeability is generally low, and there is usually a high rate of run-off resulting in heavy erosion where the soil is not covered by forests. Heavy clay soils of this type originating from shales and related material are found to a limited extent in the Sierra Madre, Catanduanes, Southern Negros, South Cotabato and Surigao.

As a general rule these soils are less fertile than those originating from limestone.

#### 2.4 Volcanic tuff

This parent material is the product of geologically recent eruptions of volcanoes. It is found in the provinces surrounding Manila, in Albay and to a limited extent in Occidental Negros. Soils developed from volcanic tuff have a rather fine texture and a highly plastic consistency. The color varies from gray to brown or black depending on the type of soil minerals and the content of organic matter. On alkaline sites of this type, the plants often show symptoms of chlorosis, probably caused by unavailability or limited solubility of iron and magnesium.

In some places volcanic soils are subject to severe erosion.

#### 2.5 Soils derived from andesite, basalts, and agglomerates

A relatively large area of soil has developed from igneous rocks of volcanic origin like basalts, andesite and agglomerates. Soils of this type are mainly found in the uplands and are in some areas still covered with forests.

Where the parent material had been very resistant to weathering, these soils tend to be quite shallow and carry only a meager vegetation. Often their fertility is low due to a low base status of the parent material or due to heavy leaching. Often these soils lack all the important plant nutrients like nitrogen, phosphorus and sometimes potassium.

Where they are deeply weathered, we generally encounter lateritic soils or latosols. Lateritic soils are characterized by leaching of silica and bases and an accumulation of iron and aluminum hydroxides in the upper horizon. If the process of laterization has progressed to a point, where the ratio between iron and aluminum hydroxides and silica oxide is greater than 2, we would speak of laterites. Soils that have not reached that point yet, but are subjected to laterization are called latosols or lateritic soils. Laterization only takes place in a hot and humid climate in soils with a pH-value below 7. In the initial stages of laterization the color of

the soil can be brownish or yellowish, but takes on a red hue later due to the presence of  $\text{Fe}_2\text{O}_3$  hydrates.

Lateritic soils have a stable columnar or prismatic structure and have a high infiltration capacity. In contrast to their favorable physical structure however, they are deficient in most important plant nutrients, particularly phosphorus and bases. Since they typically have a low pH-value, phosphorus is hardly available, and the bases like calcium, magnesium, potassium are leached easily. For agricultural use heavy applications of lime are required on these soils.

Latosols are typical for rain forest areas. When used for shifting cultivation they lose their fertility very quickly.

#### 2.6 Limestone soils

Soils developed from limestone are very common and they are found in areas from the northernmost part of Luzon down to the southernmost part of Mindanao. They are most prevalent, though, in the Visayan Islands. The parent material is mainly Tertiary coral. The coralline rocks appear in great masses and outcrops are very widespread. The formation generally does not show any stratification. The coral skeletons are often well preserved.

Many limestone soils are quite shallow with a soil depth of only 15 to 50 centimeters showing only an A/C profile, while the B-horizon is often absent.

Sometimes also soils of a purplish red color similar to laterites are found in thick layers on top of limestone or between rocky limestone outcrops, as can be seen near Baguio. It is difficult to understand, however, how thick layers of soil can be derived from rocks consisting of almost pure calcium carbonate. MOHR and VAN BAREN (1959) suggest, that the red soil found over limestone in many tropical countries possibly originates from windborne material and only to a small part from the underlying limestone.

The native vegetation of limestone soils in the Philippines is composed of the Molave-Narra Association as still preserved in Fuga Island, the northern part of Sierra Madre Mountain (Callao), and a few other places. Steep limestone formations with their thin soil cover are easily eroded and should be left under a forest cover.

For the assessment of soil profiles and the edaphic requirements of reforestation species consult Part 2, Chapter 2 and 3 of this book.

### Chapter 3:

#### CLIMATIC CONDITIONS

##### 3.1 The rainfall pattern

On a map of isohyets showing the average annual rainfall, several areas of extremely high precipitation are noticeable:

- the coast of Luzon, east of the crest of the Sierra Madre Range,
- the east coast of the island of Samar and Southern Leyte,
- the east coast of Mindoro,
- Misamis Occidental.

These areas receive heavy orographic rainfall during the winter period, when the northeast monsoon dominates. In addition to heavy orographic rainfall, the coastal region from Samar

to the North receives a good share of rainfall from typhoons.

Much of the island of Mindanao shows rainfall of over 250 centimeters annually. The high rainfall in Mindanao, other than the orographic rainfall on the east coast, is primarily due to two factors. First, this is the area over which the intertropical rain front lies for the greatest period of time. Second, Mindanao is an island large enough to give rise to convectional cells which produce local precipitation at almost all seasons of the year.

There are some places in the Philippines, that show markedly lower annual rainfall than the surrounding areas:

The Central Plain of Luzon with averages between 1500 and 2250 mm annual rainfall lies in a double rain shadow. During the southwest monsoon the Central Plain is shielded by the Zambales Mountains, which lie directly to the west of the plain. During the northeast monsoon the Central Plain is sheltered by the Sierra Madre situated to the east.

The east coast of Cebu is also protected from both monsoons. During the southwest monsoon it lies in the shadow of the highlands of Negros and the mountains of Cebu itself. During the northeast monsoon it is shielded by the highlands of Leyte. In addition the northeast monsoon winds, when they do reach Cebu, very often blow parallel to the coast; thus, they are not cooled and little rain is derived from them.

In Zamboanga City the annual rainfall averages only 1100 millimeters, because the city is somewhat shielded by the island of Basilan and also the Zamboanga Mountains.

Dadiangas (General Santos) lies in a pocket almost completely surrounded by mountains and is sheltered from prevailing winds in several directions.

##### 3.2 Variations of rainfall.

A factor of considerable importance is the reliability of rainfall from year to year. The average deviation from normal rainfall appears to be in the order of 14 percent. This figure

is relatively low, and much lower than in other monsoon countries. The variations appear to be least in the interior of Mindanao, and relatively high in Samar, and Southern and Central Luzon.

Extreme variations from 60 to 100 percent have been observed in Baguio City, Samar and Surigao. These variations are all surplus of rainfall, not deficits and coincide with years of extraordinary typhoon activity. So areas deriving a good part of their precipitation from typhoons or from the northeast trade winds show relatively high variations from year to year. Areas deriving much of their rainfall from the southwest monsoon or from the South Pacific trades show moderate variation.

Areas particularly in the south, deriving their moisture largely from the intertropical front, also show relatively small variations in their rainfall pattern.

### 3.3 Climatic types.

The classification of climatic types in the Philippines is based on differences in the rainfall distribution throughout the year, the presence or absence of a dry season and of a maximum rain period due to the combined influence of topography and wind direction.

First Type: two pronounced seasons, dry season from November to April, wet during the rest of the year. The controlling factor is topography. The localities of this type are shielded from the northeast monsoon and even in good part from the trade winds by mountain ranges, but are open only to the southwest monsoon and cyclonic storms.

Second Type: No dry season with a very pronounced maximum rain period from November to January. These regions are situated along or very near the eastern coast and sheltered neither from the northeast monsoon and trade winds nor from cyclonic storms.

Third Type: seasons not very pronounced, relatively dry from November to April and wet during the rest of the year. The maximum rain periods are not very pronounced, too, with a short dry season lasting only from one to three months. These localities are only partly shielded from the northeast monsoon and subject to frequent cyclonic storms.

Fourth Type: Rainfall more or less evenly distributed throughout the year.

### 3.4 Temperature variations.

The Philippines extend over a latitudinal distance of over 1500 km and yet, within this broad expanse, we encounter relatively small temperature variations. Aparri in the extreme north of Luzon and Jolo in the Sulu Islands have nearly the same maximum, average and minimum temperatures.

Aparri	30.4°C max.	22.8° C min.	26.3°C average
Jolo	30.8°C max.	22.7° C min.	26.6°C average
Baguio	23.1°C max.	15.0° C min.	18.2°C average

Table 2: Maximum, minimum and average temperatures of Aparri, Jolo and Baguio.

Differences in temperatures in the Philippines are mainly due to differences in elevation, as demonstrated in Table 2. Aparri and Jolo are situated at sealevel, Baguio City at 1500 m elevation.

### 3.5 Typhoons or tropical cyclones (9,13,14).

Typhoons carry exceptionally great amounts of moisture, are responsible for between one quarter and one third of the total Philippine rainfall, and have set world records for rainfall over short periods of time. The world's record 24-hour rainfall was recorded during a typhoon at Baguio City, between noon of July 14 and noon of July 15 in 1911, when 1170 mm of rain literally flooded the city. In addition to heavy rains, typhoons are accompanied by high winds, which over coastal areas often reach 200 km per hour and cause heavy damage to buildings, crops and forests.

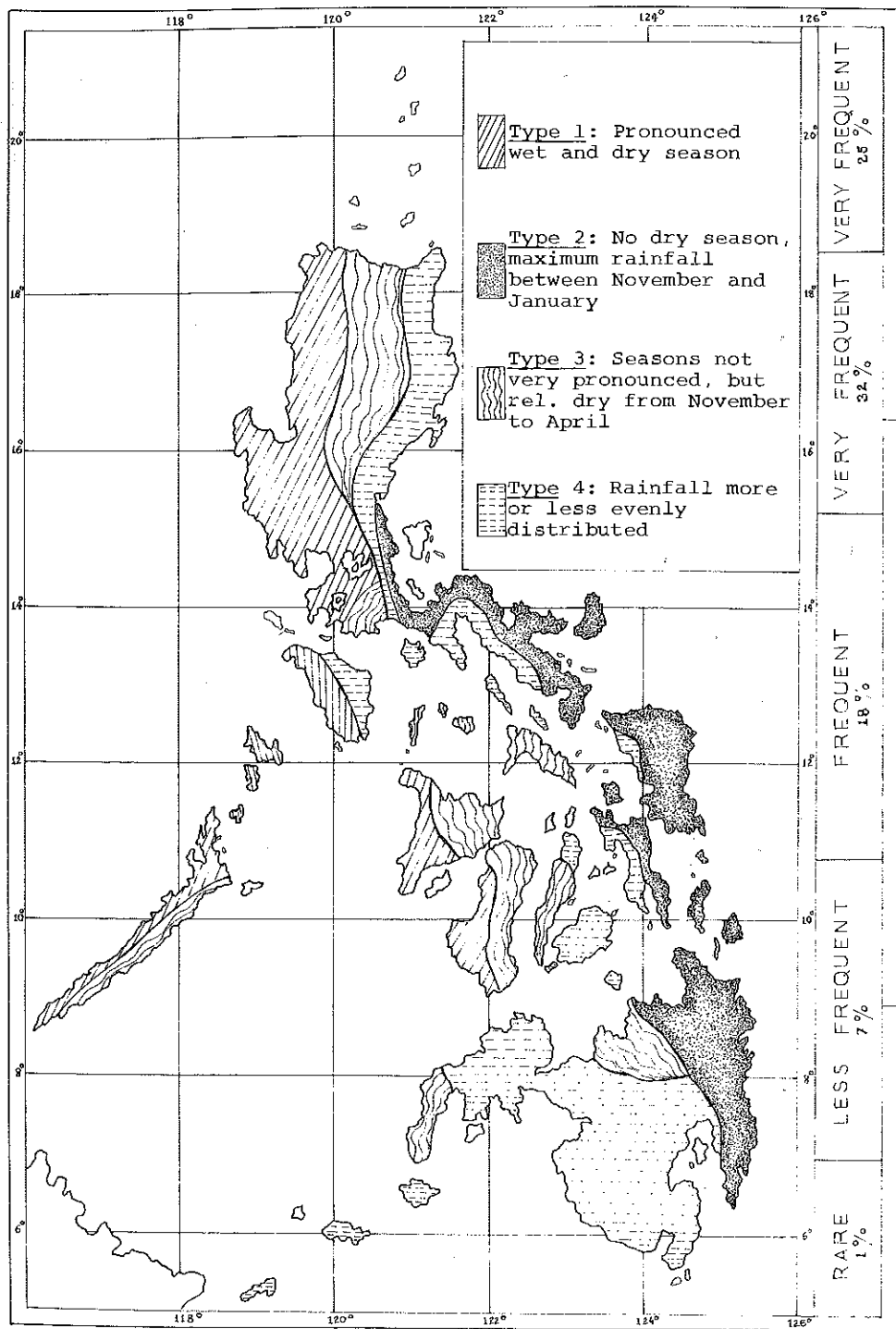

Fig. 1: CLIMATE MAP OF THE PHILIPPINES

Typhoons originate usually in the area of the Caroline or Marshall Islands. They are vast low pressure systems which in the northern hemisphere are accompanied by a counter clockwise whirl of winds gradually spiraling towards the vortex. Violent updrafts and convergence cause rapid cooling of the marine tropical air masses and heavy precipitation results. Cloud cover is normally quite dense within a 500 km radius, but the central eye or the vortex of the storm is usually marked by an area three to five kilometers in diameter where the sky is clear and where calm prevails. These storms usually move toward the west or northwest, but as they approach the continent, they generally swing to the north and eventually die out as they are forced toward the northeast in the west wind drifts.

The typhoon season last in the Philippines generally from July to November, although sometimes storms occur during other months. Typhoons most often touch the Philippines between the southern tip of Samar and Northern Luzon (See map).



## Chapter 4:

### THE NATURAL FOREST TYPES

There are over three thousand species of trees in the Philippines that can reach diameters of 30 cm or more. However, at the present stage of utilization only about 70 species find their way to the market. Seventy five percent of the annual cut consists of dipterocarp species, commonly referred to as the lauan family or Philippine mahogany. The species that make up the bulk of the volume are white lauan, apitong, red lauan, followed by mayapis, mangasinoro, bagtikan, palosapis, almon, tanguile and yakal (3).

Based on their species composition the Philippine forests are generally classified into six types (15):

1. Dipterocarp forest,
2. Molave forest,
3. Pine forest,
4. Mangrove forest,
5. Beach forest,
6. Mossy and high mountain forest.

Most of the original forest types have been altered fundamentally through human action such as logging, grazing, shifting cultivation, or have been cleared for agricultural crops. Up to now there is no map available showing the present distribution of forest types. The following table is only an estimate of the area still occupied by each type.

Type	Area (ha)	Percent	Source
Dipterocarp forest	9,352,000	62	B.F.D., 1973
Molave forest	500,000	3	rough estimate
Pine forest	269,000	2	B.F.D., 1973
Mangrove forest	218,000	1	B.F.D., 1973
Beach forest	very small area		
Mossy & high mountain forest	1,000,000	7	rough estimate
Open grassland and other	3,765,000	25	B.F.D., 1973
Total	15,104,000		

Table 3: Area of the main forest types in the Philippines.

#### 4.1 Dipterocarp forests.

The tropical rain forest of the Philippines is dominated by Dipterocarpaceae of the following genera: Shorea, Dipterocarpus, Hopea, Parashorea, Pentacme, Anisoptera, and Vatica. From the standpoint of the botanist the composition of these forests is complex, but from the standpoint of the lumberman it is relatively simple, because several different species are generally grouped under the same trade name.

Dipterocarp forests can occur from the coastal flats onwards up to about 800 meters elevation. They are best developed where rainfall is more or less uniform throughout the year, or where there is only a very short dry season. According to the dominating species association WHITFORD (1911) divides the dipterocarp forest into five subtypes:

- a) Lauan type
- b) Lauan-Hagakhak type
- c) Yakal-Lauan type
- d) Lauan-Apitong type
- e) Tanguile-Oak type

	Lauan	Lauan-Apitong	Yakal-Lauan	Lauan-Hagakhak
Dipterocarps	252 m <sup>3</sup>	116 m <sup>3</sup>	80 m <sup>3</sup>	55 m <sup>3</sup>
Others	14	52	73	28
Total Volume per hectare	266 m <sup>3</sup>	168 m <sup>3</sup>	153 m <sup>3</sup>	83 m <sup>3</sup>

Table 4: The volume per hectare of dipterocarps and other species from sample plots in 4 subtypes of the dipterocarp forest taken by WHITFORD (1911). Note: WHITFORDS conversion factors were corrected.

a) Lauan type:

In the true lauan type the relative proportion of dipterocarps and the commercial volume is usually higher than in any other type. It represents the most valuable commercial forest in the Philippines (see table 4).

Because of a dense canopy, the true lauan type is relatively free from undergrowth. The shade is so dense, that regeneration of light demanding species has no chance. This type reaches its best development in low elevation extending only to an altitude of about 300 to 400 meters. On favorable sites this type regenerates easily after logging. The second growth is usually dominated by white lauan and mayapis mixed in the earlier stages after logging with a large number of gubas, which are eventually shaded out.

b) Lauan-Apitong type: Where there is a pronounced dry season, the lauan type is replaced by the lauan-apitong type, which also occupies only lower elevations. The canopy of this type is more open allowing more undergrowth.

c) Yakal-lauan type finds its best development in regions where the dry season is short. Regarding the soil it prefers low coastal hills of volcanic origin. This type has a slight deciduous appearance during the driest part of the year. Another association where yakal is less dominant, however, is found along streams and the slopes of ravines.

d) Lauan-hagakhak type is restricted to areas where the water level is near the surface. In composition it differs from the previous type mainly by the presence of hagakhak (Dipterocarpus warburgii) and a much larger number of codominant species of other families. During the rainy season, the soil in large areas is too wet for the best development of many species. These factors reduce the volume of timber per hectare as compared with forest types growing in more stable areas (Table 4).

e) Tanguile-oak type covers the areas extending from the upper limits of the lauan and the lauan-apitong type to the lower limits of the pine or mossy forest types, from 400 to 500 meters above sea level up to 800 to 900 meters. The rainfall is more evenly distributed throughout the year, and the relative humidity is constantly higher than in the adjacent forests of lower altitudes. In the lower transition zone one may find scattered specimens of dipterocarps belonging to the forest types bordering below. Many of the species in this type also occur much dwarfed in the mossy forests higher up.

4.2 Molave forest.

The molave forest occurs in regions with a very distinct wet and dry season. They are typical for the limestone soils in the coastal areas, which are usually quite shallow and excessively drained. During the dry season, there is often the impression of semi-arid conditions. A number of trees in the molave association shed their leaves every year during the dry season.

Molave itself is a short boled, ragged tree, but has a very durable and valuable wood, which is in high demand. The forests are open with a few dominant trees far apart. Besides molave there are often kalantas, ipil, supa, narra, camagon, banuyo, tindalo and other valuable timber trees associated in this type.

Since the sites of these forests are easily accessible, most of the original forests have been destroyed by exploitation. A relatively well preserved molave forest can still be seen in the narrow coastal plain west of the Zambales Mountains. Other remains are said to exist still in the lime stone hills of the northern end of the Sierra Madre Range.

During the Spanish period ships built of molave maintained the historic Manila-Acapulco galleon trade for nearly two-and-a-half centuries.

#### 4.3 Mangrove forests.

Mangrove forests occur along the tidal flats at the mouths of streams and along the shores of protected bays. The stands are composed of eight species of the bacauan family (Rhizophoraceae), which once were the principal source of tanbark, cutch and dyebark, but now mainly produce charcoal. Where utilization had been intensive, api-api (*Avicennia officinalis*) becomes more and more dominant, because its sprouts easily.

Further upstream, where the water is not so brackish any more, nipa palm may form extensive and dense stands, which are a major source of roofing material in coastal areas.

The mangrove forests are practically clear of undergrowth. The stilt roots are as high as 3 meters. The leaves of all species are hard and leathery. The seeds are distributed by the tides until they find a suitable lodging place. Virgin areas show surprisingly large stands of poles and trees. In thickly populated areas, the forest has degraded to such an extent that it produces now only firewood. Many mangrove swamps have been cleared for fishponds.

#### 4.4 Beach forest.

This type is found on sandy beaches above the high tide limits where the original form of vegetation had been left undisturbed. Since these are very favorable sites for settlements and coconut plantations, little of the original beach forest is left.

Typical beach forest associations include Pandanus, large specimens of bitaog (*Calophyllum inophyllum*), talisay often in groups, stands of agoho on sandy flats near the mouths of rivers, duñigon-late and others.

#### 4.5 Pine forest.

There are two species of pines found in the Philippines forming pure stands: Benguet pine (*Pinus insularis*) and Mindoro pine (*P. merkusii*). While Benguet pine forests form extensive stands in the mountains of Northern Luzon, the Mindoro pine occupies only an estimated 5-6000 ha in two isolated areas in Northern Zambales and Northern Mindoro. The altitudinal range of Benguet pine extends from about 700 m onwards to about 1800 meters. The two known Mindoro pine forests occupy an area mainly between 100 and 500 m elevation.

Because of their silvicultural characteristics (Part 2, Chapter 3 of this book) the Mindoro pine has practically no economical importance in the Philippines. The Benguet pine, however, is planted now all over the islands. The growth outside the natural range of this species is sometimes higher than in the Mountain provinces of Northern Luzon.

	Height	Diameter	Volume over 7 cm
Benguet Province	14-18 m	12-15 cm	150 m <sup>3</sup> per ha
Bukidnon Province	25-27 m	20-23 cm	400 m <sup>3</sup> per ha

Table 5: Growth of Benguet pine, age 20 years, spacing 2 x 2 m.

The natural pine stands are generally quite open and subject to frequent fires. Only along creeks one can find some broad-leaved vegetation. Where fire protection can be enforced, natural regeneration appears easily. The management of natural pine forests is described in Chapter 5.

#### 4.6 Mossy forest.

The mossy forest is found above the tanguile-oak type. In Northern Luzon on southern slopes and dry ridges it is replaced

naturally by Benguet pine. The ecology of this forest type is characterized by a relatively low temperature, high and uniform humidity in form of rain and fog throughout the year, short duration of sunshine and strong winds.

A striking feature of the flora are the numerous epiphytes consisting of mosses, liverworts, ferns and orchids in great variety and also bottle-shaped myrmecodias. The trees are generally of medium height and short boled. Typical genera are Podocarpus, Dacrydium, Quercus, and Eugenia.

The mossy forest is of little commercial value, but important as a protection forest. A great portion of it in Northern Luzon has been cleared for vegetable farming. A relatively well preserved mossy forest can still be seen in the mountain range between Banaue and Bontoc.

## Chapter 5:

### MANAGEMENT OF NATURAL FORESTS

Philippine forestry has two distinct aspects namely the management of the natural forests, and reforestation and erosion control of denuded areas. Since this book is primarily devoted to the latter, management of natural forests is treated here only very briefly.

Of the different forest types of the Philippines, only the dipterocarp forest and the pine forest are under special systems of forest management based on the concept of sustained yield.

#### 5.1 Selective logging in dipterocarp forests (12).

The main objective of the Philippine system of selective logging in the tropical rain forest is to retain an adequate number of undamaged and healthy residuals to be utilized in the next cutting cycle or later, which one tries to achieve by marking the residual stand before logging. According to the official logging instructions laid down in the HANDBOOK ON SELECTIVE LOGGING, the main phases can be described as follows:

- a) Determination of marking goal. For any particular setup (area covered from one spar tree) the marking goal for residuals is either 60% of the number of healthy trees in the 20-70 cm diameter classes, or if there are more trees in and over the 80 cm diameter class than below, then 40% of all trees over 20 cm diameter. This distinction is made to allow

a reasonable number and volume of commercial trees to be retained in areas which are heavily stocked with large trees.

The marking goal is computed from a 5% sample inventory using circular 0.1 ha plots ( $r=18$  m). In this pre-marking sample inventory all commercial trees are recorded by species and diameter class.

b) Tree marking: This involves trees to be retained as residuals, and those to be cut. Trees marked as residuals are numbered consecutively with paint and are recorded individually by number, species, diameter, height up to first branch and volume. Marking is continued until the marking goal is reached and the whole set up is covered. Residuals should not be marked

- on cableways radiating from the spar tree, which have to be kept as narrow as possible,
- on log landings which should not have more than 40 m radius for the largest setups,
- in the fall direction of trees marked for felling.

Marking for felling is carried out at the same time, and all merchantable trees over the minimum diameter limit (70 cm), that are not needed to make up the marking goal, are marked with a vertical arrow on the side of the felling direction.

c) Residual inventory after logging. This is the physical examination and count of the marked residuals left in a setup after logging. The inventory crew will go over the logged setup, examine each marked tree to judge, whether it is healthy, sub-standard or damaged. All unaccounted or lost trees are noted. Unmarked healthy residuals are all recorded and numbered consecutively, but they shall not be used to replace damaged marked trees.

The residual inventory has three main objectives. One is to determine the extent and cause of damage done on the residuals to make the necessary corrections. The second objective is an appraisal of residual growing stock as a basis for silvicultural treatment and management. The third objective is to provide the

necessary information to compute fees to be paid by the concessionaire for the damaged trees.

d) Timber stand improvement: After the logging operation is completed the forest is left behind with an open canopy and exposed soil, which favors the invasion of undesirable tree species and climbers suppressing seedlings, saplings and poles of desirable species.

The first silvicultural treatment is to be applied 5 to 10 years after logging. Many foresters agree, that no tending should be attempted during the first 5 years because of the difficulty of entry and the heavy growth of climbers.

Stand improvement operations at this stage include:

- cutting, girdling and poison-girdling of undesirable trees,
- climber cutting,
- thinning, where natural regeneration is too dense.

For more detailed information consult the HANDBOOK ON SELECTIVE LOGGING.

## 5.2 Management of pine forests under the Seed Tree Method.

Within the concession areas the pine forests of Northern Luzon are generally managed under the seed tree method. This involves clear-cutting the area leaving only a few seed bearers. After the new stand is established, the seed trees may be removed in a second cut or left for the next rotation.

The number of trees to be left as seed bearers should be between 16 and 20 trees per hectare as suggested by CALEDA (loc. cit. NICHOLSON, 1970). Only large, straight-boled trees with thin branches and large crowns are to be selected. Since the quality of the mother trees will be reflected in the offspring, they should be carefully selected. An even distribution of seed trees would interfere too much with logging, therefore NICHOLSON suggests to mark the seed trees in 4-5 groups of not more than 4 trees, per hectare. The dispersal-range of pines is quite wide and natural regeneration can be expected over the whole area.

After logging the success of the natural regeneration depends largely on effective fire protection. Where regeneration is inadequate, it can be supplemented by planting.

Successful regeneration of Benguet pine by the seed tree method can be observed in the Bobok Concession east of Baguio City.

## Chapter 6:

### REFORESTATION

The creation of the "Inspeccion General de Montes" in 1863 by the Spanish government was the formal beginning of a forest service in the Philippines. This agency undertook a study of the Philippine forest resources, and laid down the regulations for opening of virgin lands and cutting of timbers. Many comprehensive laws were subsequently passed imposing also replanting, but until the turn of the century not much had been accomplished in the implementation of these laws.

After the United States had succeeded Spain, forestry received more serious attention. The war had hardly ended in 1900, when a forestry bureau was organized under US-military government, which established the base for the forestry practices that we have today.

"Most authorities trace reforestation work to have begun in 1910 with the establishment of the Forest School at Los Baños. The original school site consisted of grass and brushland. The students cleared the ground and then planted seedlings in connection with their Silviculture Class. Practical methods of planting cogonal areas were tried, and the species suitable for planting were determined. By 1916 approximately 600 species were tried in the nursery and the plantation of the school. This first attempt for the recovery of grassland paved the way for the establishment of the Makiling Reforestation Project 1937" (CUNANAN, 1968, Reforestation Monthly).

Modest reforestation outside Los Baños began in 1916 when the government appropriated the sum of 10,000 Pesos for reforestation of badly eroded government land in Cebu, where the second reforestation project was established. In 1919 three new projects were opened, namely: (1) Arayat, (2) Ilocos, which is the forerunner of the present Caniaw Project and (3) Zambales, which is now known as Magsaysay Reforestation Project.

New funds enabled the Bureau of Forestry to open the Cinchona Plantation at Impalutao and three other projects up to 1931. The period from 1916-1936 may well be called the pilot planting period, since the trial plantations of that period laid down the foundation for more extensive reforestation in the years to come.

The years 1937 to 1941 were a period of full-scale reforestation, since periodic appropriations in substantial amounts enabled the government to open new reforestation projects. Qualified personnel were employed in conducting planting surveys to determine the areas needing immediate planting and to gather data for a long-range planting plan. A special office was created under the Director of Forestry for the "round-the-clock" inspection of all new reforestation projects. Prior to the second world war, there were 35 projects in operation, covering a total area of 535,000 hectares. The total area of the forest nurseries was 24 hectares with average annual capacity of 17 million seedlings. Before World War II 28,000 hectares were already planted.

The war brought tremendous destruction on the reforestation areas.

During the Japanese occupation, the people in the vicinities sought refuge in the reforestation projects and made clearings to produce staple crops for their subsistence. Furthermore, considerable plantations and nurseries were damaged because of military operations. Only 15 percent or 4000 hectares of the pre-war plantations survived the war.

The funding problems for reforestation of the post-war years were partly solved, when Congress passed Republic Act 115 in 1947. Through this act a separate fund was constituted into which every concessionaire had to pay the amount of ₱0.50 on each cubic meter of timber from the first and second group, and ₱0.40 on timber of the third and fourth group cut and removed from any public forest for commercial purposes.

To pursue a vigorous reforestation programme, the Reforestation Administration was created as a separate government agency under the Department of Agriculture and Natural Resources in 1960. This signalled the transfer of responsibility of reforestation of approximately 5 million hectares from the Bureau of Forestry to the new agency.

After the creation of the Reforestation Administration in 1960 replanting of denuded areas was speeded up, and the annual rate of reforestation never sank below 10,000 hectares. It even reached 35,422 hectares in 1963.

In 1973 about 182,000 hectares of plantations were maintained by the Bureau of Forest Development. There are now 91 reforestation projects, 3 cooperative nurseries and 2 experimental nurseries all over the country compared to 57 reforestation projects in 1966 when the agency was founded. Of the 91 reforestation projects 46 are in Luzon, 31 in the Visayas and 14 in Mindanao.

The declaration of martial law on September 21, 1972 has resulted in the restructuring of the Philippine political system and is reflected in the reorganization of several government agencies. The Presidential Decree No. 1 and the letter of instruction No. 3 dated November 1, 1972 was issued to merge the Bureau of Forestry, the Reforestation Administration and the Parks and Wildlife Office into the new BUREAU OF FOREST DEVELOPMENT.

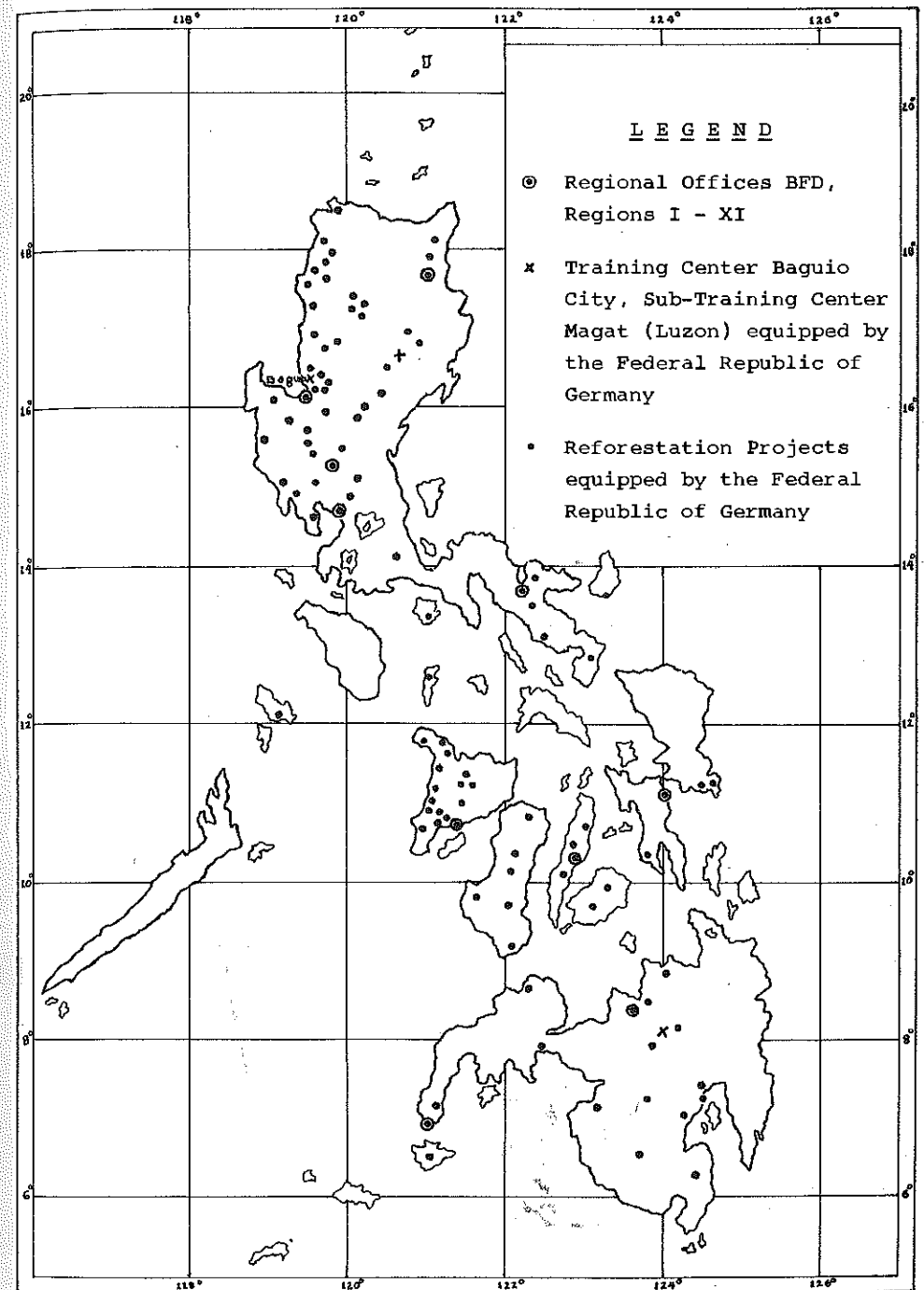

Fig. 2: Distribution of reforestation projects in the Philippines (1974).

The policy of this new office encourages tree farming and industrial plantations as well as large scale rehabilitation of denuded watersheds, which are now exclusively under the jurisdiction of the Bureau of Forest Development.-

#### REFERENCES

- (1) ALGUE, J., 1958, The climate of the Philippines  
Dept. of Commerce and Labor, Washington
- (2) BARRERA, A., 1963, Soils and natural vegetation. Manila
- (3) BUREAU OF FOREST DEVELOPMENT, 1973, Philippine Forestry  
Statistics, Manila
- (4) BUREAU OF SOILS, 1967, Reconnaissance soil survey report.  
Manila
- (5) CHOINSKI, W.F., 1967, The Philippines. Longmanns Green, London
- (6) FISHER, C., 1964, The Republic of the Philippines. London
- (7) MOHR, E.C.J. and VAN BAREN, F.A., 1959, Tropical soils  
The Hague, London, New York
- (8) NICHOLSON, D.I., 1970, Forest Management. Technical Report  
No. 3 Demonstration and Training in Forest,  
Forest Range, and Watershed Management. Report  
prepared for the Government of the Philippines.  
FAO, Rome
- (9) RIEHL, H., 1954, Tropical Meteorology. McGraw-Hill Book Comp.  
New York
- (10) ROBEQUAIN, C., 1964, Malaya, Indonesia, Borneo and the  
Philippines Longmanns Green, London
- (11) ROSELL and MAMISAO, 1965, The agricultural soils of the  
Philippines Journal of the Soil Science Society  
of the Philippines
- (12) SIAPNO, ., 1970 Handbook on selective Logging, Bureau of  
Forestry. Manila
- (13) TREWARTHA, G.T., 1967, An introduction to climate  
McGraw-Hill Book Company. New York
- (14) WATTS, I.E.M., 1955, Equatorial weather. University of London
- (15) WHITFORD, H.N., 1911, The forests of the Philippines.  
Bureau of Forestry. Manila
- (16) ZAIDE, F.G., 1970, Republic of the Philippines. Manila



P A R T II

ESTABLISHMENT, MAINTENANCE AND PROTECTION OF FOREST PLANTATIONS

H. J. WEIDELT

Chapter 1:

PLANTING SURVEY, PLANTING PLAN, PLANTATION RECORDS AND MAPS

Each reforestation project requires a detailed plan, which assures the continuity of the reforestation work inspite any changes of staff. The plan has to indicate clearly the objectives of the reforestation project and how these objectives are to be achieved (67).

In the absence of systematic planting plans the results of reforestation are bound to be patchy and erratic. Any large scale reforestation programme must be based on planting surveys, planting plans, proper plantation records, and a simple and efficient reporting system.

1.1 The planting survey

The planting survey is the basis for the planting plan and is the first to be taken up, when a new reforestation project is started. Since the procedure described by TOUMEY and KORSTIAN (1967) is widely known in the Philippines, a modified version of their methods more adapted to Philippine conditions is recommended here:

The project area is crossed at several different places taking advantage of roads and trails and any views one can have from higher points. Recording of data should be as detailed as possible without using sophisticated survey instruments. Mapping is done in form of field sketches with the help of a box compass and by pacing, or even by estimates only. The field report on a planting survey should normally cover the following items:

- (a) A general description of the topographical features of the project area including the main ridges, streams, rivers, roads and trails.
- (b) A brief history of the area regarding past fires, kaingin, timber cutting, etc.
- (c) Location and boundaries of the areas to be planted should be indicated on available base maps, or a rough field sketch must be prepared, which allows an estimate of the area. For details consult Part III,
- (d) Subdivision of the area into compartments with neat boundaries following the topographical features and differences in silvicultural treatment. The compartment boundaries are marked later by border stones or posts with painted numbers,
- (e) The soil conditions should be indicated by symbols for every compartment or subcompartment (deep, medium, shallow, rocky, sandy soil, marshy depression, fertile alluvial soil, major landslides, ravines, light, medium, heavy erosion, etc.),
- (f) The species suggested for every compartment or subcompartment are to be marked in the field sketches,
- (g) Description of existing vegetation, regeneration of desirable species, type of ground vegetation (incl. grasses, species, height),
- (h) Selection of sites for nurseries and subnurseries.

No distinction is made here between intensive and extensive planting surveys, because it does not have much significance in current practices.

### 1.2 The planting plan

All important information obtained in the planting survey should be incorporated into a concise planting plan. This plan must include:

- (a) A general description of the entire project area including location, range of altitude, topography, soil conditions,

history, present vegetation, original forest types, information on fire, kaingin, grazing, pasture leases and other hazards, landownership and possible claims.

- (b) A general description of the climate, including data on the monthly distribution of rainfall of the nearest meteorological station.
- (c) Objectives of the reforestation project, which may be watershed protection, erosion control, production of timber, pulpwood, fuelwood, minor forest products, etc.
- (d) Subdivision of the area into compartments and subcompartments according to topography, differences in site conditions, and a different choice of species. Compartment areas range from 10 to 30 hectares, the average is about 20 hectares. Compartments usually are smaller in the mountains.

The subdivision into compartments is absolutely necessary for control and reference purposes.

- (e) A tabular compilation of all compartments and subcompartments with designation (numbers for compartments, small letters for subcompartments), area, species, spacing, quantity of seed or seedlings required.
- (f) Necessary improvements of the road and trail systems.
- (g) Nursery plan for main and subnurseries, which includes the location, the area, and the number of seedlings to be raised each year.
- (h) A discussion of the area not recommended for planting with supporting reasons (too wet, dense brush, already adequately stocked, needed for other purposes, etc.)
- (i) Maintenance of the plantations during the first 5 years, including weeding, tending, fertilizer application, fire lines.
- (j) A time schedule, according to which the different compartments are to be planted stating priority areas within the project.
- (k) Equipment and supplies required.
- (l) A detailed estimate of the expenditure for each year.
- (m) Appendix of maps.

The planting plan should cover at least a period of 5 years and must be prepared sufficiently ahead to allow enough time for seed collection and raising of nursery stock.

If a number of years has passed since the time of the planting survey, a brief inspection of the area should be made to consider any changes which might have occurred.

Planting plans for different projects can be summarized into a more general plan for a region. The regional plan should have a list of priority projects.

### 1.3 Plantation records

A pre-requisite of good management is that proper records on all plantations or compartments are maintained in every reforestation project.

For each plantation (compartment or subcompartment) a special registration sheet is maintained, on which all important events and data are recorded. This register has to be updated constantly.

According to FAO recommendation (28) the plantation register or plantation index card should contain the following information:

- Designation of plantation, compartment or subcompartment,
- Area
- Species and seed source,
- Spacing
- Date of planting, estimated number of seedlings, size and quality of planting stock,
- Date of replanting, number of seedlings, size and quality of planting stock,
- Events and date of occurrence, such as fire, insect attack, tending operations, inventories, survival counts, thinnings, etc.

<u>Compartment:</u> 9	Itogon Reforestation Project	
<u>Species:</u> Benguet pine	<u>Origin:</u> Bobok Concession	
<u>Area:</u> 18 hectares	<u>Spacing:</u> 2 by 2 meters	
<u>Planted:</u> October 1969,	45 000 seedlings, bare root, 12 cm.	
<u>Replanted:</u> July 1970,	30 000 seedlings, potted, 18 cm.	
	July 1971,	7 000 seedlings, potted, 27 cm.
<u>Events in the plantation:</u>		
March 1970:	5 hectares burnt	May 1971: Survival 78 %
May 1970:	Survival 33 %	July 1971: Replanted
July 1970:	Replanted	Nov. 1971: Ring weeding
October 70:	Ring weeding	May 1972: Survival 84%

Table 1: Plantation index card.

### 1.4 Plantation maps

In every reforestation project there should be base maps available of the entire project area, preferably at a scale of 1 : 10,000. Maps at a scale of 1 : 20,000 would show the plantation areas too small. If the map supplied by the Central Office in Manila is too small, a special request must be made for enlargement. Base maps contain only the important geographical features like roads, rivers, creeks, buildings and settlements, and other important landmarks as tie points. Most important is that all boundaries of compartments and subcompartments are printed on the maps for control and reference purposes. Without the subdivision of the project area into compartments no efficient control is possible. All reporting has to be done by compartments, so that any figure reported can be easily checked in the field later.

Progress of reforestation is indicated by using a different color for every species. In a more advanced stage the different age classes (class I: 1-10 years, class II: 11-20 years, etc.) can be shown by different shades of the same color. For the main reforestation species the same colors should be used throughout the country.

A number of such base maps should be available in every reforestation project to be able to record different features

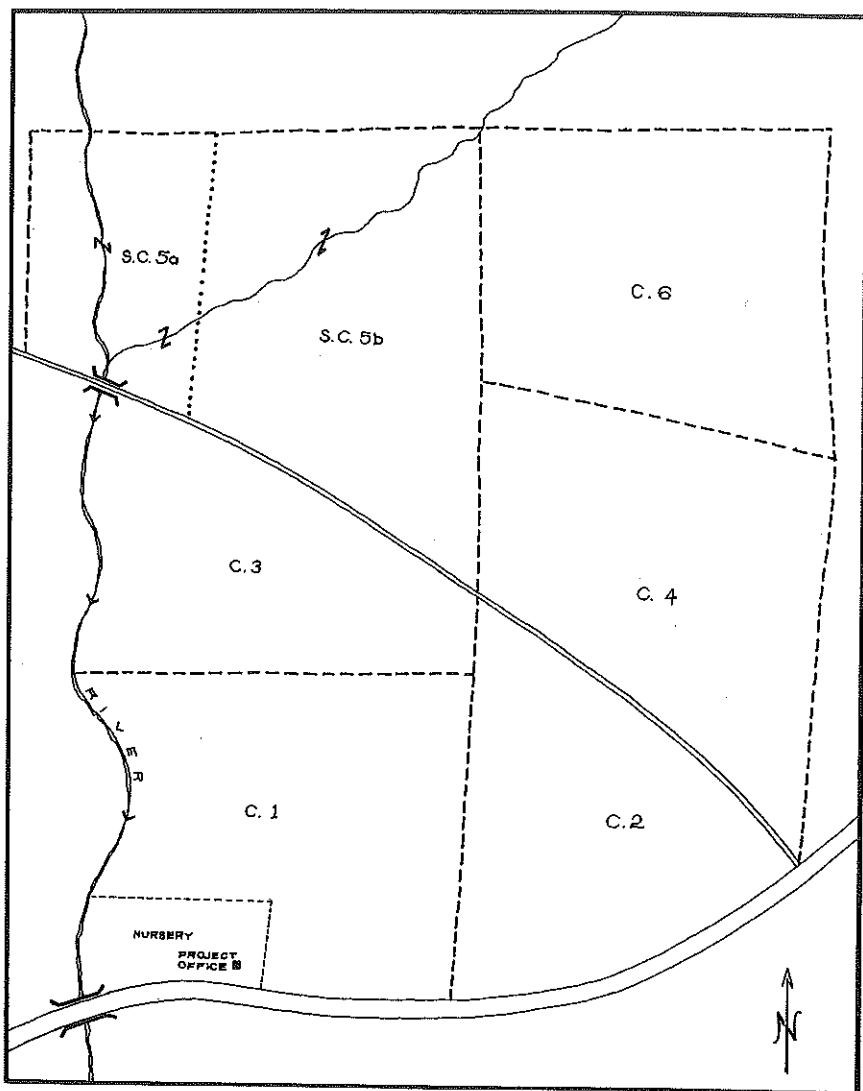

Legend: Scale 1:10,000  
 == Highway ----- Compartment boundary (trails)  
 == Dry weather road ..... Subcompartment boundary  
 ~~~~~ Geographical feature, which is not a compartment boundary

Fig. 1: Project map (base map)

of the project, whenever required, as for example the extent of fires, distribution of species, progress of planting work, future plantation areas by years, priority areas, extent of erosion, etc.

Most important is the map showing the extent of plantations. This map must be updated every year at the end of the planting season, and a copy is submitted to the Central Office in Manila to update the master copy. Without any maps of the project area a proper management is not possible.

Chapter 2:

ECOLOGICAL ASPECTS FOR THE CHOICE OF TREE SPECIES

The main ecological factors, which decide whether a species will be able to succeed on a site, are climate and soil conditions.

2.1 Climatic factors

If we would consider the climatic factors influencing tree growth on a worldwide basis, we would have to deal with a great number of climatic features such as among others the

occurrence of frost and snow, variations of relative humidity, daily and seasonal temperature variations, etc. But here we have to consider only the Philippines and can limit ourselves to only those basic climatological features, which show significant variations within the country, and allow us a more simple and practical approach.

a) Rainfall:

- The total annual rainfall helps us to classify a site by one figure only in dry (below 50 inches), moist (50 - 100 inches), and humid (over 100 inches). The disadvantage is, that this does not say much about the moisture conditions throughout the year, because the rainfall can be very unevenly distributed.
- The monthly distribution of rainfall gives us an indication of the length of the wet and dry season, and therefore has more significance than the total annual rainfall. An attempt of a classification and a suggestion of suitable tree species is made below:

(A) Dry season less than 4 months \*): Anthocephalus chinensis,  
Eucalyptus deglupta,  
Albizia falcata,  
Octomelis sumatrana,  
Hevea brasiliensis,

(B) Dry season 4 to 6 months \*): Swietenia macrophylla,  
Tectona grandis,  
Pterocarpus indicus,  
Pterocarpus vidalianus,  
Gmelina arborea,  
Toona calantas,  
Leucaena leucocephala

In higher elevations:

Pinus insularis,  
Eucalyptus spp.,  
Alnus maritima,

(C) Dry season 6 months or more \*): Vitex parviflora,  
Gliricidia sepium,  
Psidium guava,  
Anacardium occidentale,

\* ) A month is considered as dry, when the rainfall is below 50 mm

- Rainfall types according to the official classification of the Philippines do not lend themselves easily for classification of forest sites, because in the rainfall types II, III and IV (see Part I) rainfall can be expected in practically every month of the year, and the same group of species (group (A) above) can be planted in all three climatic types. All species requiring a seasonal wet and dry climate would have to be listed summarily under type I rainfall (groups (B) and (C) above).

It should be noted, however, that the classification attempted above is only a broad guideline for the choice of tree species, which may have to be modified locally because of changes in soil conditions, adverse exposure, changes in altitude, and other factors.

b) Temperature:

In spite of the wide extent of the country the change of latitude does not have so much influence on the temperature to affect the choice of tree species significantly. Temperature variations from one place to the other in the Philippines are mainly due to changes in altitude (21).

The commonly accepted gradient is  $0.5^{\circ}\text{C}$  per 100 meter rise in elevation. For example the difference in elevation between Baguio and Binga is about 1000 meters, we therefore can expect, that the temperature in Binga is  $\frac{1000 \times 0.5}{100} = 5^{\circ}\text{C}$  above the temperature prevailing in Baguio.

This difference of  $5^{\circ}\text{C}$  has already a great effect on the growth of tree species. While in Binga teak, narra, molave, kalantas and other lowland species can still be grown and bear seeds, they would usually not thrive in Baguio. 600 to 700 meters above sealevel seems to be the upper limit for most lowland tree species in Luzon.

## 2.2 The edaphic factors:

The most important soil characteristics influencing tree growth are the depth of the soil, the humus content, the permeability, the moisture regime, the content of rocky material, the nature of the subsoil, the availability of nutrients and the pH-value. Assessment of these characteristics is generally part of the planting survey and can -except the last two items- be determined by inspection of a soil profile. But even without making a chemical analysis we can draw some conclusions about the availability of nutrients and even the pH-value from the ground vegetation, the presence of humus, the thickness of the A-horizon, the soil structure and the color.

If the special technical terms for a soil description are not known, a free description of what is actually seen should be made. A simple guide for a profile assessment is given below:

- (a) General information: Location of the profile,  
topography of the profile site,  
geological information, if available,  
climatic conditions,  
vegetative cover, dominant species,  
local soil names, if any.
- (b) Estimate of the soil fertility is generally not difficult by considering the natural vegetation found at the profile site. For site classification purposes it is recommended to develop a system of indicator plants, which are characteristic for special soil conditions.
- (c) Depth of soil:
- |                  |             |
|------------------|-------------|
| less than 30 cm. | - shallow   |
| 30 to 100 cm.    | - medium    |
| 100 to 200 cm.   | - deep      |
| over 200 cm.     | - very deep |
- (d) Moisture at time of profile description:
- dry: color becomes darker, when water is added,

fresh: color does not change, when water is added,  
moist: if sample is pressed by hand, water will show,  
wet: if sample is pressed by hand, water will run out.

- (e) Usual height of water table taking into account the weather conditions.
- (f) Drainage: Terms generally used in profile description are  
excessive (in sandy soils),  
free (for "normal" soils),  
imperfect (often in slightly compacted soils with a high clay fraction)  
impeded (often in lower horizons of clay soils, where the soil is compacted, and in profiles situated in a depression)
- (g) Separation of the profile into horizons:
- O-horizon: undecomposed or semi-decomposed litter,  
A-horizon: characterized by the presence of soil humus. The color is generally darker than the underlying B-horizon ("topsoil").  
B-horizon: The horizon of mineral soil between the A-horizon and the underlying parent material ("subsoil").  
C-horizon: The parent material, mostly undecomposed rocks and other material, where the soil forming process has not yet started.

If within the A, B, and C horizon significant differences in color, texture, etc. occur, a further subdivision in line with the conventional symbols used in soil science should be attempted. Each horizon is described separately indicating its depth. Example:

0 - 15 cm. A-horizon: ...  
15 - 120 cm. B-horizon: ...  
below 120 cm. C-horizon: ...

The following items (h-n) must be described for each horizon separately:

- (h) Color: The description should be as specific as possible, for example: dark reddish brown, light yellowish brown, mottled grey and red brown, etc. . Compare also the color with the horizon below and above: lighter or darker.
- (i) Texture class: refers to the distribution of fine and coarse particles in the soil. The main texture classes can be easily determined by field characteristics (33):
- Sand: A wet sample does not stain the hands,
- Loamy sand: slightly sticky, but does not allow to be formed into a stick of cigarette thickness,
- Sandy loam: makes a sound, when rubbed between the fingers close to the ear. Allows to be formed into a stick of cigarette size.
- Loam: Allows to be formed into a doll with arms and legs. Rubbing between the fingers makes a very light sound only.
- Clay loam: Sample allows to be formed into a fragile string. No sound when rubbed between fingers.
- Clay: highly plastic and slippery when handled. Allows to be formed into a thin string.
- (j) Skeleton percent: Estimate of the proportion of coarse particles (over 2 mm) in the soil. Also a description of their nature is required: "approximately 20% skeleton consisting of platelike stones with an average size of 2 - 3 cm."
- (k) Soil structure: Sometimes more clearly pronounced in old profiles or road cuts, in a fresh profile the structure becomes more obvious, when

a shovel of soil is thrown on the ground and the soil breaks up into aggregates. Descriptive terms commonly used are plate-like, prismatic, blocky (very common), granular or crumb structure (A-horizon), or "no visible structure".

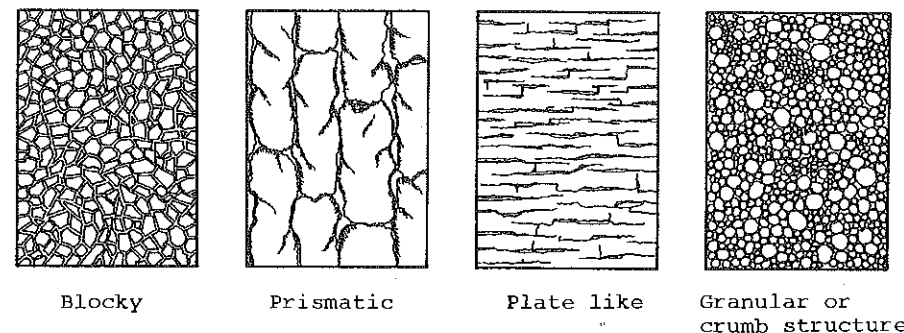

Fig. 2: Types of soil structures.

- (l) Compaction: terms commonly used in soil profile description are: for dry soils: loose, friable, firm, very firm, cemented, for moist soils: sticky, non-sticky, plastic.
- (m) Root penetration: use a free description: "many fine roots, isolated strong roots, horizon well penetrated by roots" etc.
- (n) Presence of soil fauna: earth worms, termites, ants, mice or others.

To assess these soil characteristics a profile pit of about 1.5 m depth is dug on a representative site avoiding places, which are not really characteristic of the area like ridges, small depressions, vicinity of creeks and rivers etc.. Sometimes road cuts provide a very large and deep soil profile that one can save the labor for digging a pit.

On table 1 (next page) some tree species had been suggested for some typical soil types. This brief outline, however can provide only some basic ideas when selecting a tree species and does not eliminate the necessity to conduct trial plantations, whenever a new species is introduced to a region.



| S O I L                                              | DRY SEASON LESS THAN 4 M.                                                             | DRY SEASON 4-6 MONTHS                                                          | DRY SEASON MORE THAN 6 M.                       |
|------------------------------------------------------|---------------------------------------------------------------------------------------|--------------------------------------------------------------------------------|-------------------------------------------------|
| dry rocky ridges                                     |                                                                                       | alibangbang, guava<br>molave, akleng parang                                    | alibangbang, guava<br>molave, akleng parang     |
| rocky soil with high<br>skeleton content             | Gmelina arborea, bagras,<br>Moluccan sau, ipil-ipil,                                  | casoi, guava, molave,<br>akleng parang, ipil-ipil<br>kalantas,                 | molave, casoi, guava,<br>akleng parang,         |
| very shallow soils                                   |                                                                                       | akleng parang                                                                  | akleng parang                                   |
| sandy soils near<br>seashore                         | agoho, bitaog, talissai,<br>aroma                                                     | agoho, bitaog, talissai<br>aroma, kamachile                                    | agoho, kamachile,                               |
| red and brown soils<br>originating from<br>limestone |                                                                                       | kalantas, narra, molave<br>Gmelina arborea, ipil-<br>ipil                      | molave, kakawate                                |
| deep and well drained<br>lowland soils               | kaatoan bangkal, bagras<br>Moluccan sau, Para rubber<br>Gmelina arborea               | teak, narra, mahogany,<br>Gmelina arborea, lumbang<br>ipil-ipil, Honduras pine | kalantas, molave,<br>Eucalyptus citriodora (?)  |
| fresh alluvial soils<br>near creeks and rivers       |                                                                                       | Gmelina arborea, narra<br>and many others                                      | forest species and<br>fruit trees               |
| soils with impeded<br>drainage                       | Eucalyptus robusta,                                                                   | banaba, Eucalyptus ro-<br>busta, Casuarina glauca                              | banaba, Eucalyptus robusta,<br>Casuarina glauca |
| grassland soils under<br>cogon                       | Benguet pine, Eucalyptus<br>spp., Alnus maritima                                      | Benguet pine, Alnus,<br>Eucalyptus saligna,<br>E. grandis,                     | Benguet pine,<br>Eucalyptus camaldulensis       |
| mountain forest soils<br>of good quality             | Cryptomeria japonica, try also Cunninghamia konishii<br>and Chamaecyparis formosensis |                                                                                |                                                 |

Table 2: SUGGESTED TREE SPECIES FOR SOME TYPICAL SITE CONDITIONS

## Chapter 3:

ECOLOGICAL NOTES ON SOME REFORESTATION SPECIES IN THE PHILIPPINES1) Acacia farnesiana. Aroma

This large spiny shrub is native to South America, but now widely distributed throughout the tropics. The tree is very common along the West coast of Luzon and Mindoro and many other places. It was seen growing very well on coastal sands and may have good prospects for degraded and sandy sites in low elevation and for erosion control purposes. Due to its long spines it is not very attractive as fuelwood or fodder, which is a big advantage in some places.

2) Agathis philippinensis. Almaciga

Almaciga is a large tree with a wide distribution throughout the Philippines on moist, but well drained mountain slopes at elevations from about 300 to 1500 meters. It is not allowed to cut almaciga, because it yields a valuable resin known as copal.

Because of short viability the propagation by seed is difficult. The usual method of propagation is by wildlings, which can be found in great numbers under the mother trees, after the ground vegetation has been cleared. The young seedlings benefit from a light shade and are well suited for underplanting or enrichment planting. Almaciga requires a moist, well drained site with a humid atmosphere (forest environment) with only a short dry season, and does not seem to be suited for open grassland.

3) Albizzia falcata. Moluccan sau

A fast growing tree from the Indo-Malayan region. It grows well up to elevations of about 600 meters in Luzon, in Mindanao it can be grown also at higher elevations as in Cinchona Reforestation Project, Bukidnon. Albizzia falcata does best on a variety of soils, but best growth rates are obtained on good forest soils.

The tree is liable to wind damage and therefore should not be planted in the typhoon belt, where the branches are easily stripped off by strong winds. Albizzia falcata performs a useful function as a nurse crop, wherever light shade is required to raise more delicate species by underplanting.

Large commercial plantations of this species can be seen at the concession of the Nasipit Lumber Company in Agusan, Mindanao, where a mean annual increment of about 30 cu. m per ha is obtained on average sites and over 50 cu. m on good sites. Local yield tables are available.

4) Albizzia lebbekoides. Kariskis

A small tree with a wide distribution throughout the Philippines. Suitable for planting on dry and rocky sites.

5) Albizzia procera. Akleng-parang

This tree is common in regions with a pronounced dry season, namely the Ilocos Provinces, and is often encountered in open secondary forest. Since the tree is able to grow on very shallow soil, it may be a very useful species for difficult sites. The wood, although of small dimension, can be used for many purposes.

6) Aleurites spp.

Aleurites trisperma (bagilumbang) is indigenous only to the Philippines, while A. moluccana (lumbang) has a very wide natural distribution and had been established in plantations throughout the country. In the Nasipit Lumber Concession lumbang is planted at a commercial scale in combination with cattle ranching. The climatic and soil requirements of both species are not very specific.

A third species, Aleurites fordii, which yields the tung oil, has been recently introduced in the Philippines (Magat Reforestation Project) and is supposed to grow well on dry sites.

7) Alnus maritima (?). Japanese Alder

This medium sized tree is suitable for elevations above 600 meters. It grows well on landslides and degraded soils and therefore performs a useful function in erosion control as long as the site is not too dry.

8) Anthocephalus chinensis (syn. A. cadamba). Kaatoan Bangkal

A fast growing pioneer tree of the rainforest area, which sometimes appears in masses where the soil had been disturbed by construction of logging roads.

The ecological requirements of this species are uniform rainfall, moist and well drained forest soils and full light. Planting therefore is only recommended in type II rainfall areas without a pronounced dry season. Plantations in the drier parts of Luzon have all failed, while on favorable sites in Mindanao a mean annual increment of 50 cu m /hectare and more had been recorded.

9) Bauhinia malabarica. Alibangbang

This and other species of the genus have only value as ornamentals and can be tried in groups for beautification on dry ridges and other dry and rocky sites.

10) Calophyllum inophyllum. Bitao

Common throughout the western Pacific region near seashores. The species is suitable for planting on coastal sands, but due to the slow growth Casuarina equisetifolia is generally preferred. Other species of this genus thrive also in inland plantations in drier places.

11) Casuarina spp. Agoho

Two species of this genus, Casuarina equisetifolia and C. rumphiana are native in the Philippines, while a third species C. montana was introduced from Australia.

- Casuarina equisetifolia: a pioneer on fresh deposits along rivers and along the sea coast. The species is recommended for planting on coastal sands and degraded sites in the lowland.
- Casuarina rumphiana: native in the moist mountain forests of the Philippines at elevations around 1000 meters. It is a beautiful tree, but apparently not often cultivated.
- Casuarina montana (syn. *C. junghuniana*): Most of the agohe planted at higher elevations seems to be *C. montana* (?). The species is very hard to distinguish from *C. equisetifolia*. Because of the ecological differences, however, the distinction of the two species is important:

|                   | <i>C. montana</i>                                                            | <i>C. equisetifolia</i>                       |
|-------------------|------------------------------------------------------------------------------|-----------------------------------------------|
| Twigs ("needles") | 8-10 teeth at each node                                                      | 5-8, mostly 7 teeth at each node              |
| Fruits ("cones")  | more truncate, smaller<br>5-6 whorls of fruit cells<br>8-10 cells in a whorl | more elliptic, larger<br>7-8 cells in a whorl |

12) Cryptomeria japonica. Japanese Cypress

Some old specimens are found around Baguio as ornamentals, but they do not look very vigorous. *Cryptomeria* likes a deep, moist and well drained soil and is suitable only for higher elevations. A plantation established at Mt. Data at about 2500 m was growing well until burnt 1973. Seedlings showed slow progress during the first two years in the field, but then put on rapid growth. In the mountainous parts of Agusan young plantations showed extremely fast growth. The question of the proper provenance is very important for *Cryptomeria japonica*. In neighboring Taiwan the YOSHINO provenance from Central Japan gave best results. Provenance tests for the Philippines are recommended.

13) Dipterocarps.

Most species of this very large and important family regenerate naturally easily on undisturbed or slightly disturbed forest soils. Their artificial regeneration, however, is difficult. The seed years are irregular and the seed has only a very short viability.

Plantations have been established successfully by underplanting with wildlings of white lauan and bagtikan (Malaybalay Reforestation Project, Mindanao), because all dipterocarps require shade in their early juvenile stage. Most attempts of planting them in open plantations have failed.

If dipterocarps are considered for planting at all, trials should be conducted on forest soils under shade in regions with more or less evenly distributed rainfall. For details on planting dipterocarp wildlings and enrichment planting with dipterocarps see Chapter 11 and 16.

14) Endospermum peltatum. Gubas

The frequency of this medium to large tree increases in overlogged dipterocarp forest, where gubas can be considered a secondary species. Since it is in high demand for matchsticks and matchboxes, it is already planted in some places. The tree seems to be best suited for fresh forest soils in areas with more or less evenly distributed rainfall. The seeds require a special treatment to break or avoid dormancy (PCAR, 1975).

15) Eucalyptus camaldulensis.

This species is widely distributed all over Australia, including some areas with very low rainfall. Plantations of *E. camaldulensis* have been established successfully under various climatic conditions in many tropical and subtropical countries.

Trial plantations at elevations above 600 meters in Luzon were quite successful. At lower elevations trial plantations of this species had been a total failure in some places and a success in others. Therefore small trial plantings are recommended before starting any larger plantation in lower elevation. It should be noted here, that most *Eucalyptus* species are very sensitive to weed competition, and may require a careful site preparation. This may be one of the reasons for failure in some places.

A provenance test with 50 Australian provenances of this species was conducted by the Training Center in 1972 at the Binga plantation site. The result so far has been, that .

only some provenances from the most northern parts of Australia (North of 18°) gave promising results at the difficult site at Binga and seem to be well suited for dry mountain areas where the choice of species is very limited.

16) Eucalyptus citriodora.

In its natural habitat this species occurs from sealevel up to 600 meters under rainfall from 600 to 1000 mm. The tree is very adaptable in respect of soil and rainfall conditions.

In the Philippines it should be given a trial on drier sites at lower elevations.

17) Eucalyptus deglupta. Bagras.

This is the only eucalypt indigenous to the Philippines. It requires a moist and well drained soil and is not a species for dry sites or areas with a very pronounced dry season, though the species appears to be quite adaptable. On favorable sites the increment can be extremely high and a mean annual increment of over 50 cu m can be obtained.

Large commercial plantations of this species can be seen in Surigao del Sur, Mindanao, where also natural stands of this species are found.

18) Eucalyptus robusta. "Swamp mahogany".

This species grew well in trial plantations in Bukidnon and the Cagayan Valley (46). As the Australian name suggests, it prefers marshy sites and heavy soils. It can be grown also on light soils, as long as they are not too dry. On dry sites the tip may die back, when the trees reach pole size.

Eucalyptus robusta does best under uniform rainfall, even in lower elevations.

19) Eucalyptus saligna.

A very fast growing tree, which should be tried on moist sites in Mountain Province and higher elevations in Mindanao. The species is not suitable for dry and rocky sites.

Very sensitive to weed competition. Some specimen trees can be seen around Baguio as ornamentals.

20) Eucalyptus grandis.

The tree is very similar to Eucalyptus saligna and also requires a moist and well drained soil at elevations above 600 meters. It is not suitable for dry sites. Very sensitive to weed competition. There may be natural hybrids with the former species.

21) Gliricidia sepium. Madre de Cacao, Kakawati.

This species was introduced from Central America and is very common in the Philippine lowlands up to about 600 meters elevation. It can be easily established on dry and poor sites by cuttings, and therefore is very useful for erosion control at lower elevations. It is also a good nurse crop capable of improving the soil conditions because of the high nitrogen content of its leaves (49).

22) Gmelina arborea. "Melina", Yemane (Mindanao).

A species with roughly the same natural distribution as teak stretching from India to Indochina.

Gmelina has grown well in the Philippines under a variety of site conditions, and has become the favorite of many foresters. Due to its good early growth it can generally cope with the weeds with little or no assistance. The tree is quite adaptable to different rainfall conditions and can be planted in all four rainfall types of the Philippines. However, regarding soil conditions, the species is quite demanding. According to LAMB (1968) Gmelina not only requires good drainage, but also a high base status. Ample available nitrogen is probably essential for vigorous growth of Gmelina.

On difficult sites the tree is shortlived, sometimes dying without apparent cause already at the age of about 10 years. In a trial plantation in Binga the trees grew well during the first 2 years but then height growth stopped almost

completely. On favorable sites the tree lives up to 40 years and can attain diameters of 60 to 80 cm (41).

- 23) Leucaena leucocephala. (Syn. *L. glauca*) Ipil-ipil.  
An introduced tree from Mexico and Central America, which is already naturalized in the Philippines.

Once established the tree grows and regenerates easily at elevations below 600 meters and occasionally is seen above 1000 meters. It prefers the moist and more fertile lower slopes and does not like acid soils. Regarding rainfall ipil-ipil is quite adaptable, but does not do well on very dry sites with southern exposure.

*Leucaena* can be grown from seed or cuttings and coppices well, therefore it may be a useful species for erosion control at lower elevations. In Laguna Province it is managed under a coppice system to provide fuelwood for the Greater Manila Area. On Java/Indonesia it is a very important nurse crop in all taungya plantations, where it is sown in lines between teak and other species. The young trees are lopped frequently to provide mulch for improving the soil conditions.

In a test with 104 strains of *Leucaena leucocephala* conducted at the Hawaii Agricultural Experiment Station a strain from Mexico had been outgrowing all other strains (9) and had been introduced to the Philippines recently as "giant ipil-ipil".

- 24) Mangifera indica. Mango

This very common fruit tree grows easily and fruits at elevations up to about 600 meters in Luzon on a variety of soils and succeeds also on rather dry sites. Planted on favorable sites around forest plantations the wide crowned mango trees will shade out grasses and provide an effective fire break.

- 25) Pinus caribaea var. hondurensis.

This is one of the few pine species besides *P. merkusii* and perhaps *P. oocarpa*, which can be grown successfully at lower elevations in the tropics. In a 7 years trial plantation north of Baguio the species was outgrowing the native *P. insularis*.

- 26) Pinus insularis (syn. P. khasya). Benguet Pine

This species is indigenous to the mountains of North Luzon and should be used for all grassland sites at elevations above 800 meters. At lower elevations the trees tend to exhibit a very poor shape and slow growth. The poor shape at lower elevations could possibly partly be attributed to increased shoot borer attack.

At Malaybalay Reforestation Project, Mindanao, an old plantation of very tall and straight pines can be seen at 600 meters elevation, but up to 1970 these trees produced little or no viable seed.

- 27) Pinus merkusii. Mindoro Pine

The tree occurs naturally in the Philippines in two small isolated areas in NW Mindoro and the Zambales Mountains. Very little planting has been done with this species in the Philippines so far, because the seed is difficult to get, it has a short viability and the seedlings are delicate and slow growing.

An additional disadvantage of the Philippine provenances of this species is, that they have a "grass stage", which does not occur in the provenances of North Sumatra and increases the weeding costs considerably.

For lower elevations it may be worthwhile to try the Atjeh strain from North Sumatra.

- 28) Pinus oocarpa.

Seedlings planted near Baguio have shown growth rates similar to the indigenous *Pinus insularis*.

WORMALD (1969) recommends trial planting with *P. oocarpa* v. *ochoteranai* at elevations below 1000 meters.

- 29) Pithecolobium dulce. Kamachile

A medium sized tree from tropical America, now widely distributed and naturalized in the Philippines. The species is

able to grow on dry sites and coastal sands, suitable for erosion control in low elevations, source of tannin.

30) Psidium guaba. Guava

Besides bearing edible fruits guavas are very hardy, deep rooted, and drought resistant, they can be planted on extreme sites on southern slopes and rocky ridges, where almost nothing else would grow. Once fully established, they cannot be eradicated easily and survive grass fires.

31) Pterocarpus indicus. Narra

Most of the original narra forests near the coasts are already destroyed by kaingin, cleared for agriculture, or altered by heavy timber cutting. According to WHITFORD (1911) narra is found throughout the Philippines, principally in regions where the dry season is not pronounced, nearly always occupying places on flat coastal plains behind mangrove swamps or very scattered along streams in the low hills near the coast. Very rich narra stands were also found in the Cagayan Valley.

Though the tree appears to be quite adaptable to dry sites, it may not reach the quality here required for sawn timber due to excessive forking and, as a result, short boles.

32) Pterocarpus vidalianus. Prickly Narra

The Philippine national tree. It is distinguished from *P. indicus* mainly by the prickly fruit, the site requirements are the same as for *Pterocarpus indicus*.

33) Samanea saman. Raintree, Monkey Pod, "Acacia"

This tree has been introduced probably by the Spaniards from Central America. It is frequently encountered in towns and along roads at elevations below 600 meters. The wood is in high demand for the wood carving industry.

Site requirements are not very specific, but the tree seems to be most suited for moist, but free draining sites in the lowlands with a pronounced dry season.

34) Sesbania grandiflora. Katurai

This very useful small tree occurs naturally throughout the Indo-Malayan region up to Northern Australia. It is cultivated now in most tropical countries. The flowers can be eaten as a vegetable, the leaves serve as fodder for milk cattle, an extract of the barks is prepared as a medicine against bowel complaints, the wood is used as fuel.

In the lowland of the Philippines and Java the tree is a common sight in moist places along rice fields and near homes. It is also found sometimes as a pioneer in abandoned kaingins.

35) Swietenia macrophylla. Large Leaf Mahogany

This species has proved to be one of the most successful trees for reforestation in the Philippines as long as it was not attacked by the shoot borer. It thrives under rainfall from 1500 to 5000 mm. and a dry season up to 5 months. In a moist climate the trees are taller and growing faster, but the quality of the dry area mahogany is superior. Mahogany is essentially a tree of lower elevations and should not be planted above 600 meters in Luzon.

In respect of soil requirements the species is quite adaptable and on rather shallow as well as deep alluvial soils.

Shoot borer attack (*Hypsipyla robusta*) is often serious especially on good sites and can perhaps be reduced by growing mahogany in mixtures or under a light shelter of *Albizia falcata* to avoid the formation of long sappy shoots, which are of special attraction to the insect (6). Where shoot borer attack cannot be controlled other species must be chosen.

36) Swietenia mahogani. Small Leaf Mahogany

This species is able to grow on drier sites than *Swietenia macrophylla*, but the growth rate is slower.

37) Tectona grandis. Teak

Teak has been widely planted on grassland sites throughout the country. The great advantage of this species is, that it can be easily raised in the nursery, easily established in the field by stumps and sprouts after grass fires.

However, the rate of growth and the form of the trees are generally very poor in most plantations. It is not clear, whether this is a question of the site (degraded grassland!) or of unsuitable seed origin. Provenance tests with good Thai and Indian provenances including the famous Nilambur Teak from South India or Malabar provenances are suggested.

The value of teak in plantations with purely protective functions in dry areas is doubtful, since teak is deciduous and may take a very long time to suppress the grasses to a degree, where groundfires cannot do any harm (67).

Teak is a very demanding species and should be confined to rich, well drained soils, which are often really agricultural soils and should not be planted on dry rocky slopes.

38) Toona calantas. Kalantas

This species is found scattered throughout the Philippines on a variety of sites: along small streams in the molave forest, on flood plains in the lauan-hagachac forest (66), on dry slopes in the Ilocos Region, in the rain forest of Palawan, the Visayas and Mindanao. This wide distribution shows, that the species must be quite adaptable to different soil and rainfall conditions. At the Caniaw Reforestation Project in Ilocos Sur it is planted at a large scale on dry rocky slopes. On moist and fertile sites the plantations are liable to shoot borer attack like most Meliaceae. Preventive measures are described in Chapter 23.

Since the species yields a useful timber, is easy to raise and can be planted bare root, it should be given more attention.

39) Vitex parviflora. Molave

Usually a small to medium sized tree of very ragged shape and a crooked and fluted bole, but of very high value, because of its resistant timber. According to WHITFORD (1911) the tree was once widely distributed throughout the islands, especially on low coastal hills, usually on limestone, but may also occur on volcanic rocks and other sites.

It is suitable for very dry and rocky sites with southern exposure, but due to its slow growth it had been rarely planted at a larger scale.

Chapter 4:

THE OBJECTIVES OF REFORESTATION AND THE CHOICE OF TREE SPECIES

When selecting a tree species for a planting project, we must in the first place always consider the species which grow best under the given ecological limitations. The second consideration then is which of the possible species serves best the purpose of the plantation and gives us the maximum benefit. Since the ecological aspects have already dealt with in the two previous chapters, the purpose of tree planting will be analysed here more in detail.

Objectives for planting trees can be one or several of the following:

- 1) Production of sawnwood, veneer and plywood,
- 2) Production of pulpwood,
- 3) Production of fuelwood,
- 4) Production of poles and piles for local consumption,
- 5) Production of "minor forest products" like rubber, fibers, tannin, resin, fruits, etc.
- 6) Erosion control,
- 7) Protection and improvements of watersheds,
- 8) Shelterbelts,
- 9) Beautification.

When making our choice, we should try to find a species, which serves not only one, but several of the above listed objectives to cope with the multiple-use functions of the forest.

#### 4.1 Production of sawnwood

When the main objective of a plantation will be to produce sawnwood, we have to consider, that the trees we plant today, will be harvested only after 30 to 100 years. The problem for the forester is to predict, what will be required by the market a long time ahead. In spite of all future technical developments, increased competition from other materials, and a noticeable trend towards composite wood products, foresters generally are convinced, that there will always be a demand for good quality sawnwood. CHAMPION and BRASNET (1958) recommend general utility timbers as a safer investment in the long run than special purpose timbers with increased competition from other materials.

Another point, which has a bearing on the choice of tree species, is the necessity to concentrate on relatively few species, after the stage of species trials has passed. The trade and the wood based industries always want large quantities of the same product. Small quantities even of a very

useful species, to which the trade is not yet accustomed, from an isolated plantation may be very difficult to sell in most cases. The tropics are very rich in timber trees, and there is the danger for the enthusiastic forester to plant too many species. Of course also the other extreme of large monocultures with all the risks involved has to be avoided. If the existing species satisfy the demand, there will be no need to introduce unpredictable exotics. In the Philippines so far the species, which make up the bulk of industrial plantations, can be counted almost on one hand.

If a new species is to be introduced to a region, trial plantations have to be established, which should cover at least 1/3 or better 1/2 of the proposed rotation, before one can embark in any larger operation. Observations in the nursery and early plantation stage are not enough.

Under Philippine conditions the following species may be considered for sawnwood production in plantations:

|                                       |                     |
|---------------------------------------|---------------------|
| Swietenia macrophylla                 | Gmelina arborea     |
| Tectona grandis                       | Albizia falcata     |
| Pinus insularis                       | Eucalyptus deglupta |
| Pterocarpus indicus and P. vidalianus |                     |

Plantations of these species may become more and more important for the sawnwood supply in future, as the remaining dipterocarp forests will be depleted.

#### 4.2 Production of pulpwood.

The present annual paper consumption of the Philippines is about 0.4 million tons. The increase in consumption during the last decade has been about 7% annually, and the consumption had doubled since 1961 (1).

The consumption of paper is intimately linked to the standard of living or the per capita income. The higher the standard of living and the educational level, the more the people consume paper and paper products. There is more demand for books, newspapers, magazines, writing paper. The increased consumption of goods leads to a higher consumption of wrapping



and packing materials. With the rising standard of living combined with a high population growth of 3.4% annually, we can predict a sharp increase in paper consumption, and therefore increased need for pulpwood plantations. Still quite a large proportion of the pulp and paper needed is imported, but these imports are regressive. Imported is also still a large portion of the long fiber pulp, which is blended with short fibers to produce strong paper grades or kraft paper.

In the Philippines out of 3800 woody species about 200 are suitable for pulp (1) especially

- Benguet pine (*Pinus insularis*)
- Moluccan sau (*Albizia falcata*)
- Kaatoan bangkal (*Antocephalus chinensis*)
- Bagras (*Eucalyptus deglupta*)
- Yemane (*Gmelina arborea*)

Besides these species, which are already planted at a large scale for pulpwood, the Forest Products Research Institute at Los Baños recommends also a long list of others (52). Some of these, which have a potential for plantations, are African tulip (*Spathodea campanulata*), Binuang (*Octomelis sumatrana*), gubas (*Endospermum peltatum*) and luctub (Dua-banga moluccana).

In a recent work ESCOLANO et al. (1974) have investigated kraft pulping of a number of non-commercial hardwoods, some of which like Toog showed fiber length over 1.6 mm, but may present silvicultural difficulties for mass production.

In a pulpwood plantation, considerations about stem form, branchiness and taper play only a secondary role. The main aim is to produce quantity measured by volume and weight, because about 4-6 tons of wood are required to produce one ton of pulp. The following aspects therefore have to be considered already in the planning stage:

- Since a pulp mill requires very large quantities of wood for economical operation, dry areas where trees are growing slow are unsuitable for pulpwood production. Water must be available in large quantity, because about 40 cu. m. of water are needed for one ton of pulp.

- Pulpwood is bulky, the value per unit is not as high as logs. Therefore pulpwood cannot be produced in remote areas. The plantations have to be situated as close to the pulp mill or a motorable road as possible and must be concentrated to reduce transportation cost. Small, widely scattered plantations are a great handicap for the development of any wood based industries (26).

- The species usually planted for pulpwood are fast growing. The pulp mill therefore has to be planned simultaneously with the planting programme. After 8 to 10 years we can expect the first pulpwood to be harvested and there must be a mill to utilize it.

- The number of species planted in a pulpwood plantation project should be limited, because pulping of a heterogeneous mixture of hardwoods is still difficult. From the silvicultural point of view, however, the project is more safely founded, when several species are planted, and large monocultures are avoided. Usually a compromise has to be made between the silvicultural aspects on one side and technical and economical on the other, which could result, for example, in a block mixture of different species and age classes.

#### 4.3 Production of fuelwood.

In the Philippines fuelwood still continues to be important for the lower income groups, especially in the rural areas. The fuelwood demand of the Greater Manila area is met by the ipil-ipil plantations of Laguna. In Central Luzon heavily pollarded rain trees and katurais provide fuelwood in purely agricultural areas without remains of forest. According to estimates about one half of the worlds wood consumption of 2.5 billion cu.m. is still consumed as fuelwood. With the present energy crises the demand for fuelwood is likely to increase.

As pointed out by CHAMPION et BRASNET (1958) wood as a fuel has the great advantage over all other sources of energy, except hydro-electric, that, properly managed it is permanently self-renewing, and can be produced almost everywhere

where land and moisture is available. The great disadvantage, however, is that fuelwood is quite bulky in respect to its calorific value, and costs for transport and handling are therefore relatively high. In most cases it would not be economical to transport felling waste from the logging areas to the centers of consumption. Where it can be expected, that a demand for fuelwood is likely to continue, special plantations of easy growing species managed under a coppice system may be the best solution.

When selecting the species one should take into account the calorific value as well as silvicultural factors. One should not only select a species, that grows fast, but also one which regenerates easily naturally by seeds or coppice. Most fuelwood plantations in the tropics have been established with legumes. For the Philippines ipil-ipil, kakawate or *Cassia siamea* appear to be most suitable. Species, which have to be replanted after each cutting cycle are unsuitable for fuelwood plantations, except, if they are especially adapted to a site, where nothing else would grow.

In the Philippines the most common species for fuelwood plantations is ipil-ipil. Most of the ipil-ipil sold in Manila comes from the Los Baños area, where extensive plantations of this species can be seen. The rotation there is only 2-5 years. Land reasonably stocked with ipil-ipil produces about 4000 bundles per hectare per rotation(30), which would be equivalent to about 6-10 cu. m. staked per year. The "giant ipil-ipil" probably would produce much more.

#### 4.4 Poles and piles for local consumption.

Foresters should always bear in mind the needs of the local people to assure their cooperation. In rural areas there is usually quite a high demand for piles and poles for simple construction and fences. The lower the income in a certain part, the more the people use roundwood and less sawnwood. With rising income the roundwood consumption will fall and is replaced more and more by sawnwood.

In forest areas there will be no need for making special plantations to satisfy this demand for poles and small wood. The always present secondary forest will provide enough material. Where we have closely spaced plantations for timber production, the thinnings can often be sold to meet the demand for poles (16).

If permanent difficulties in the supply exist for an area, bamboo plantations would be highly appreciated by the local population, since bamboos rank among the most useful and versatile forest products. Due to its ease in working and its availability bamboo is used in the Philippines for almost every purpose wood is used in temperate countries (30). Bamboo is used for house construction in many areas, serves as water container, or pots for raising tree seedlings, split boho is woven into a coarse matting called "sawale" used for walls and partitions in houses, or it can be used for fish traps or fences. During the Vietnam War deadly traps were constructed only of bamboo and vines to be triggered off by unwary soldiers, the "balatec" made of bamboo is still in use to trap wild boar in some places.

Bamboo also can be a source for long fiber pulp like in Sulawesi (Indonesia). The technical difficulty to a certain extent still is the high silica content which destroys the knives of the pulping machines.

Of the 17 erect species of bamboo found in the Philippines, the three species most widely used are (30):

- Kawayan (*Bambusa spinosa*): This spiny variety is the most commonly used bamboo in the Philippines due to its strength and durability. It is thick walled with internodes of 40 to 60 cm and can attain a height of 25 m and a culm diameter of 20 cm. Kawayan had been introduced to the Philippines a long time ago, possibly from Indonesia.
- Kawayan-kiling (*Bambusa vulgaris*): This species occurs now all over the tropics and is considered a pantropical species. It is difficult to decide, where it is native and where it was introduced by man. The height is less than *Bambusa spinosa*, and the culms have a thinner diameter and thinner walls. Where it occurs, it is extensively utilized.

- Boho (*Schizostachyum lumampao*): This thinn-walled species is widely distributed in lower hill forests and covers extensive areas in the foothills of the Mountain Provinces in Luzon.

It is easily understood, that a properly managed bamboo grove near a village would be of great value to the community. Larger bamboo plantations could be the basis of raw material for a number of industries.

Propagation of bamboo is done by root cuttings or root suckers, with some species also stem cuttings are successful. Seed years occur only at long intervals, after which all the bamboo over a wide area dies. If there is a seed year, this opportunity for mass propagation should be utilized to raise potted bamboo seedlings. For further information on bamboos consult McCLURE (1966).

#### 4.5 Production of "minor" forest products.

The number of trees in the Philippines, which yield other products than wood, is very vast. But here we want to deal only with some species, which are cultivated for their special products. These products are often termed "minor" forest products (10), although they can be very important for the local economy, and their value per unit of area may in some cases even exceed the value of wood production. Some examples for forest trees, which are cultivated in the Philippines for other products than wood, include

- Para Rubber (*Hevea brasiliensis*). The largest commercial plantations in the Philippines are found in Mindanao and Basilan Island. Commercial firms plant now only high yielding varieties, which have to be grafted. Their yield is several times higher than that of the wild tree.
- Cinchona spp. yield the alkaloids quinine, cinchonine and quinidine. A bitter extract of the bark is also used for the manufacture of tonic water. Cinchona species are native to Peru and Ecuador and have since long been used for the cure of malaria. For cultivation they require a humid mountain climate.

A 225 hectare plantation was started already in 1929 near Malaybalay in Bukidnon at an elevation of about 1500 meters, known today as the Cinchona Reforestation Project.

- Lumbang (*Aleurites moluccana*). The kernels yield the lumbang oil, which is used to make paint, varnish, linoleum and wood preservatives.
- Almaciga (*Agathis philippinensis*, syn. *A. alba*). A large tree with broad needles belonging to the Araucariaceae. It produces a resin known as Manila Copal in the international trade. The best quality copal comes from Palawan and Quezon Province. Almaciga is widely distributed in the humid hill forests of the Philippines. Artificial regeneration of this species is mainly by wildlings, because the seeds have a very short viability.
- Pili (*Canarium ovatum*). This tree yields two valuable products: the famous pili nut and the Manila elemi, a resin used for the manufacture of varnish. The pili nut is a delicacy known especially from the Bicol Region, where the tree is cultivated. *Canarium ovatum* belongs to the Burseraceae and attains a height of about 35 meters and a diameter up to one meter.
- Buri Palm (*Corypha elata*). The largest of all Philippine palms. It yields the buntal fiber used for the manufacture of fine hats in Central Luzon. The fiber is extracted from the petiole of the immature leaf. The sap is used to make tuba, an alcoholic drink. The trunk contains starch, which can be extracted. The leaves are used extensively for making baskets and mats. The buri palm occurs all over the Philippines and is cultivated locally. After flowering the palm dies.

Besides these few examples of minor forest products given above, there is also a vast number of edible fruit-bearing species worth cultivating on favorable micro sites along creeks within forest plantations and along trails. A comprehensive annotated list of edible fruit-bearing tree species had been compiled by Prof. Jacalne (1960). Fruits gathered from plantation areas may improve the diet of the local population and stimulate their interest in protecting the plantation from fire.

#### 4.6 Planting for erosion control.

For erosion control not only trees but also shrubs, grasses and other plants, which can provide vegetative cover, can be used. Very often the native flora of the project area contains very useful species for erosion control, which should be given a test, even if these species are considered weeds and have never been propagated before. The requirements for suitable species are

- the species must be able to succeed on degraded sites,
- it should have a deep and wide spread root system,
- it should be able to improve the soil conditions by producing plenty of litter, or should be able to fix atmospheric nitrogen in symbiosis with nitrogen fixing bacteria,
- for many methods of erosion control (brush covers, etc.) only species, which sprout from cuttings can be employed,
- the species must be able to withstand draught followed sometimes by superabundance of water,
- a rapid development is desirable to achieve the protection quickly,
- the species should give some economical returns like lumber, fuelwood, edible fruits or other useful products.

Species, which proved to be very suitable for slope stabilization in Mountain province, were Mexican sunflower (*Helianthus* sp.), Lantana (*Lantana camara*), and Japanese alder (*Alnus maritima*). For lower elevations bamboos and legumes like kakawati (*Gliricidia sepium*) and ipil-ipil (*Leucaena leucocephala*) are recommended.

#### 4.7 Protection and improvement of watersheds.

The main objective of most reforestation projects in the Philippines so far is the establishment of protection forests, many of which have important functions in delicate watershed areas.

Reforestation generally is the best way of conserving soil and water in mountainous catchment areas. A forest cover raises the water storage capacity of a watershed and minimizes silting of reservoirs. The requirements for species suitable for the protection and improvement of degraded watersheds are basically the same as those listed for erosion control. In most cases we shall find it difficult, if not impossible, to select a species, which meets all the desirable requirements listed above. The best solution would therefore generally be a mixture of several species (preferably by groups), which are complementary in their beneficial effects on the watershed.

It must be kept in mind, that only in special cases it is justified to establish a forest with only protective functions, which gives no direct economic returns. Under restricted utilization and special management also a forest in a watershed can yield timber and other forest products.

Very few quantitative data exist on the effect on the hydrological cycle of different tropical tree species: how much rainfall they intercept, how much water they consume for their own transpiration, how they influence the water retaining capacity of the soil. Species, which are deciduous like teak, narra, Gmelina are likely to consume less water for transpiration during the dry season than evergreen species. This may be a point to be considered in low rainfall areas, where springs may dry up, if the watershed is under evergreen forest.

#### 4.8 Shelterbelts

The reduction of wind velocity on both sides of a shelterbelt consisting of several lines of trees and shrubs can result in decreased destruction on homes, gardens and agricultural crops, and increases the yield from the protected fields. The value of a shelterbelt is the higher, the more valuable the land or the crops it protects. In the typhoon belt of the Philippines, where extreme wind velocities of about 200 km./h. are to be expected almost every year, well

maintained shelterbelts would possibly reduce some of the damages. It can be expected, that the loss of productive area through the shelterbelts will be more than compensated by their benefits.

The choice of suitable species depends on what grows best under the ecological conditions of the area. Within these limitations desirable characteristics are (16):

- wind firmness,
- rapid development,
- ability to coppice,
- economic value.

In many tropical countries casuarinas and eucalypts especially *Eucalyptus camaldulensis*, have been successfully planted for shelterbelts. In the Philippines also legumes like ipil-ipil and kakawati would be useful. Most effective is a mixture of medium to tall trees in the center and small trees and shrubs on the outside of the belt, so that the shelter belt assumes a triangular cross-section. As a rule of thumb in planting a shelterbelt one uses 1/3 seedlings of tall to medium trees and 2/3 shrubs and small trees.

A main shelterbelt should not have less than five rows of trees or shrubs planted at a close spacing of about 1 by 1 meter. When the trees are grown up, and do not provide protection in the lower sections any more, some trees may be cut. After coppicing the full protection is re-established. The trees cut can be used as fuelwood. If no coppice can be obtained, overgrown shelterbelts must be underplanted.

A slightly permeable shelterbelt, which absorbs part of the wind energy, has proved to be more effective than a solid barrier, which only diverts the wind. The depth of the area protected depends on the height of the trees. A noticeable decrease of wind velocity can be felt on the lee as far as 15-20 times the tree height. Also on the windward side a slight reduction of the wind velocity can be noticed a short distance before the shelterbelt.

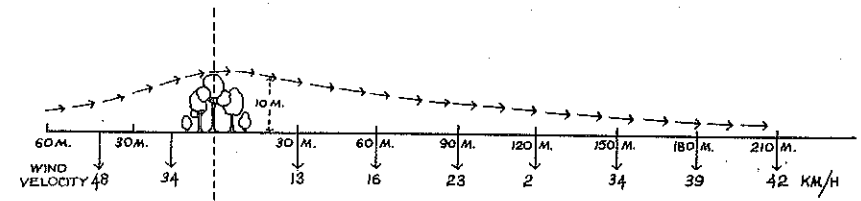

Fig. 3: Reduction of wind velocity by a shelterbelt (After GANGULY and KAUL, 1969, modified)

The interval between the shelterbelts where high wind velocities are to be expected, should be about 100 meters, under ordinary conditions about 200-300 meters.

#### 4.9 Tree planting for beautification.

Foresters are responsible for about 50 percent of the Philippine land surface. Consideration of amenity aspects is one of their duties, especially in the vicinity of towns and cities. More and more foresters willingly or unwillingly are getting engaged in beautification programmes, which have become important public issues in some places. Often foresters are asked for their expert advice to recommend suitable species. A brief list of common ornamental trees and shrubs, which are quite robust and grow on a variety of climate and soil conditions, are listed below:

##### a) Trees with bright flowers

Bottle brush (*Calistemon lanceolata*),  
 Banaba (*Lagerstroemia speciosa*),  
 Dap-dap (*Erythrina variegata*),  
 Fire tree (*Delonix regia*),  
 African Tulip (*Spathodea campanulata*),  
 Calachuchi (*Plumeria acutifolia*),  
 Alibangbang (*Bauhinia* spp.)  
 Jacaranda (*Jacaranda mimoseifolia*),  
 Pink and yellow flowering Cassias (*C. fistula*, *C. spectabilis*, *C. siamea*),

##### b) Trees with beautiful foliage or needles

Norfolk pine (*Araucaria excelsa*)  
 Japanese cypress (*Cryptomeria japonica*)  
 Cupressus fragrans, *C. lusitanica*,  
 Malaalmaciga (*Podocarpus blumei*)  
 Igem (*Podocarpus javanicus*)

Arbor-vitae (*Thuja orientalis*),  
 Pitogo (*Cycas rumphii*, *C. circinalis*),  
 Silverdollar (*Eucalyptus cinerea*),  
 Silky oak (*Grevillea robusta*),  
 Agoho (*Casuarina equisetifolia*),  
 Balete (*Ficus* spp.).

Palms

Buri palm (*Corypha elata*),  
 Betelnut palm (*Areca catechu*),  
 Pugahan (*Caryota cumingii*),  
 MacArthur palm (*Actinophloeus macarthurii*)  
 Dwarf coconut palm (*Cocos nucifera*),  
 Tikal (*Livistonia* spp.),  
 Royal palm (*Roystonea elata*),

c) Shrubs with bright flowers or colorful foliage

Poinsettia (*Euphorbia pulcherrima*),  
 Gumamela (*Hibiscus* spp.),  
 Yellow bell (*Solandra hartwegii*),  
 Calliandra haematocephala  
 Baston de San José (*Cordyline terminalis*)  
 Bougainvillea, several shades,  
 Sampaguita (*Jasminum sampac*),  
 Gardenia jasminoides,  
 Lantana (*Lantana camara*),  
 and many others

For more species consult ORNAMENTAL PLANTS OF THE PHILIPPINES by  
 M.L. STEINER.

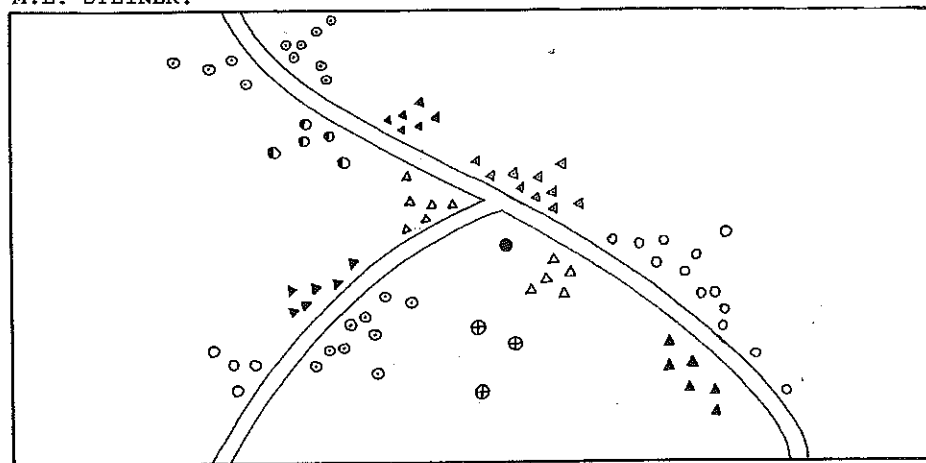

Fig. 4: Beautification along a road with 4 tree and 4 shrub species.  
 ● *Araucaria excelsa*, ○ *Cupressus* sp., ⊙ Agoho, ○ Bottle brush  
 ▲ Poinsettia, △ Yellow lantana, △ Hibiscus, △ Baston de san Jose

The arrangement of trees and shrubs has to follow the rules of modern landscaping as an "expressive, harmonious, and refined imitation of nature" (23). Emphasis is on group planting with irregular spacing within the groups. The ground plan of groups or the relative position of the individual trees and shrubs has to be varied as much as possible. There may be single trees neighboring small groups of the same species, but an intimate mixing of single trees and shrubs of different species has to be discouraged.

Symmetry and any quasi-symmetrical arrangements as well as planting of straight lines especially along paths has to be avoided as much as possible, because it looks unnatural and awkward.

If only a small space is available mainly shrubs and only a few trees should be chosen.

MIXED AND PURE PLANTATIONS

Virgin forests in tropical countries are nearly always composed of a heterogeneous mixture of a great number of species. Pure natural stands are frequent in the cooler regions of the northern hemisphere. In reforestation a decision must be made frequently, whether a pure or a mixed stand would be best suited for the site and the objective of the plantation. Therefore we have to analyse the pros and contras of mixed and pure plantations in some detail.

5.1 Arguments in favor of mixed plantations

- a) Mixed stands appear to be more natural, especially in the tropics, where pure natural stands are rare.
- b) A mixed stand is possibly more resistant against pests and diseases. It is well accepted, that extensive pure and even-aged stands can promote mass reproduction of forest insects and infestation by fungus diseases.
- c) Mixed stands are perhaps better able to make full use of the site, especially if the crown region consists of light demanders and the lower strata of shade bearers. The same applies to the root zone, where shallow and deep rooted species can take up nutrients from different soil layers.
- d) By a skillful group mixture the variations of the planting site can be better utilized, because for each of the varying site conditions the proper species can be selected, which is perhaps the strongest argument for mixed plantations.

- e) Where planting of trees has only protective functions a mixed plantation with species complementary in some respects may be more effective than a pure plantation. While some species are deep rooted, others improve the soil by plenty of litter, others may yield useful products. All these benefits are indispensable in a protection forest, but usually cannot be obtained from one species alone.

5.2 Arguments in favor of pure plantations

- a) Pure stands are easier to handle from the technical and silvicultural point of view. If in a mixed stand the components are not extremely well suited for each other, without the constant interference by a skillful silviculturist and proper thinning the more aggressive species will eventually take over, and the final result will be a pure or almost pure stand. To maintain an artificial mixture up to maturity requires much silvicultural skill.
- b) It will be of advantage for the logging operation, if there is only one species, and the entire crop can be harvested at the same time. The logging operation becomes very complicated, when different rotations have to be adopted for the components of the mixture, and felling damages would be unavoidable.
- c) If the plantation is established for the purpose of pulpwood production with a very short rotation, there would be no point to start with a mixture.
- d) In spite of all biological arguments in favor of mixtures, long term increment studies in Europe have shown clearly, that mixtures generally do not produce more than pure stands (69).

Summing up the arguments in favor of mixed and pure plantations we see, that the points in favor of mixed plantations are more of a biological nature, while those for pure stands consider more practical and economical aspects.



### 5.3 Types of mixtures

In spite of all arguments against mixtures there are many cases, where a mixed plantation presents the best solution, but is essential to adopt the right type of mixture. The following possibilities exist:

- a) Intimate or single tree mixture: Mixing by single trees requires the greatest judgement in the selection of the species for the mixture. In general, height growth must be similar, if all the species are expected to get along with each other. In practice this seldom works out well. Distributing a number of species uniformly over the planting area has to be strongly discouraged. The greater the number of species in a mixture, the greater is the uncertainty of the ultimate result (64).
- b) Mixing by lines: Establishment of a mixed plantation by alternate lines of different species has generally the same disadvantage as single tree mixtures. It will also lead to a struggle for survival of species with possibly different growing characteristics, in which the weaker will finally be eliminated by the more aggressive.

If one wants a line mixture to be maintained up to the end of the rotation, it would be more advisable to mix the species by several lines alternating, so that a number of lines takes "group character".

- c) Group mixtures: In most instances even-aged mixtures are best obtained by group mixtures. As a rule of thumb the minimum diameter of the group area should be one tree length (about 30 meters). On the upper side there is no limit for the size of the "group" in the mixture, the different species may even occupy a whole subcompartment or compartment, and may take the character of separate stands. A skillful group mixture based on the ecological requirements of its components is the best way to utilize the varying site conditions within the plantation area.

Technical problems arise generally in the supervision of planting group mixtures. It is not sufficient to point out the area for each species vaguely to the laborers,

but to have it demarcated temporarily by pegs or poles and to issue very clear instructions. The presence of a forester or foreman during planting is necessary.

- d) Block mixtures: This is a compromise combining some of the advantages of a mixed with those of a pure stand. The blocks have an area of one or several hectares, which is sufficient to allow economic harvesting methods. Adjacent blocks can have different species or a substantially different age. Since many pests and diseases show a marked preference for certain age phases, mixing different age phases by blocks could possibly increase the pest resistance of the forest, where mixing different species is not possible. Block mixture should be considered in planning large pulpwood plantations.
- e) Mixture by underplanting: In this case light demanders are underplanted with shade bearing species or species, which require shade in their juvenile stages.

Examples: Benguet pine underplanted with dipterocarps (Malay-balay Reforestation Project, Bukidnon, Mindanao), or pines underplanted with *Alnus maritima*, which is a very compatible mixture. In areas where mahogany is heavily attacked by the mahogany shoot borer (*Hypsipyla robusta*) a light overhead shade would avoid the formation of long sappy terminal shoots, which are of special attraction to the insect. According to BEESON (1961) under a light canopy the attack would be considerably less than in the open. *Albizia falcata*, which casts a very light shade, planted a few years ahead, would probably be the best solution. The trees can be poisoned or girdled, when no longer needed. Necessary thinnings must always be carried out, b e f o r e any underplanting is undertaken.

- f) Temporary mixtures: There are instances where a mixture is intended only for a limited time as in the mixed taungya plantations of teak and *Leucaena leucocephala* in East Java. Here, teak is sown in alternate lines with *Leucaena*, which is lopped every year before flowering to provide mulch rich in nitrogen and to protect the bare soil from erosion.



When the teak plantations form a closed canopy, the *Leucaena* is eventually shaded out. Generally the objective of a temporary mixture is that the temporary component of the mixture serves the better development of the more valuable species.

## Chapter 6:

### SPACING OF FOREST PLANTATIONS

There are great variations of spacing in forest plantations in different parts of the world. *Limba* (*Terminalia superba*) in West Africa is often planted 8 by 8, or even 10 by 10 meters, which means 100 to 156 trees per hectare. On the other extreme in Germany there used to be a spacing in pine and beech plantations of 0.25 by 1.3 meters, which amounts to more than 30,000 seedlings per hectare.

In the Philippines most species are planted at a spacing of 2 by 2 meters regardless the purpose of the plantation. But here we want to give now some more thought to this question.

#### 6.1 Aspects to be considered in spacing:

- a) The site conditions: On good sites the seedlings can be wider spaced than on poor sites, because of faster growth they soon form a closed canopy and make full use of the site potential. On the other hand, by planting at a wide spacing on an adverse site, the trees would take a long time to form a close canopy and to utilize the site fully.
- b) The objective of the plantation: For the production of good quality sawnwood, especially with coniferous species, one has the choice between close spacing to avoid the formation of strong branches, or a wider spacing combined with artificial pruning. Which to adopt depends mainly on economical conditions such as labor wages, demand for poles, appreciation of better timber quality, etc.

In pulpwood plantations generally no thinning is carried out, branchiness plays only a secondary role, planting therefore is done at the final spacing.

If planting is for protective purposes, it will be essential, that the plantation closes up as quickly as possible, consequently spacing should be close. The same applies to fire breaks, which are planted close to shade out grasses quickly.

- c) The growing characteristics of the species: Spacing should be modified according to the growth rate, tendency to branch and the ability to survive under field conditions. Species, which grow fast in their early stages can be spaced much wider than slow growing species. Trees with a natural tendency to branch like narra (*Pterocarpus indicus*), should be planted closely, if timber of good quality is wanted.
- d) Market conditions: Where poles from thinnings can be sold at a profit or at least at the cost of their removal, close spacing has silvicultural advantages. If it is uncertain, whether any thinning would be carried out at all, it would be safer to plant at a wider spacing.

## 6.2 Recommended spacing for some reforestation species:

|                                        |                      |
|----------------------------------------|----------------------|
| pinus                                  | 2 x 2                |
| mahogany                               | 2 x 2                |
| teak, good sites                       | 2 x 2                |
| medium sites                           | 1.5 x 1.5            |
| Gmelina arborea                        |                      |
| good sites                             | 3 x 3 or 4 x 4       |
| average sites                          | 2 by 2               |
| ipil-ipil                              | 1 x 1                |
| narra                                  | 1.5 x 1.5            |
| Moluccan sau                           | } 3 x 3 or           |
| kaatoan bangkal                        |                      |
| other fast growing<br>on fertile sites |                      |
| Eucalyptus, fast growing               | 3 x 3                |
| Eucalyptus, others                     | 2 x 2                |
| mulberry (for sericulture)             | 0.5 x 2 m or 1 x 1 m |

### Special plantations

|                          |                  |
|--------------------------|------------------|
| plantation in high grass | 3 x 1.5          |
| taungya plantations      | 3 x 1.5          |
| enrichment planting      | 10 x 3 or 15 x 3 |
| seed orchards            | 6 x 6            |

## 6.3 Spacing arrangements

Besides the aspect of "distance" between the plants we also have to consider different spacing methods or spacing arrangements.

a) Square method of spacing: This kind of spacing is most common.

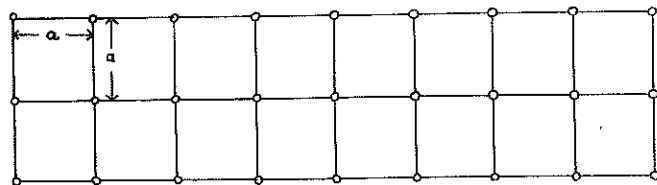

Fig. 5: Square method of spacing.

b) Rectangular method of spacing or line planting:

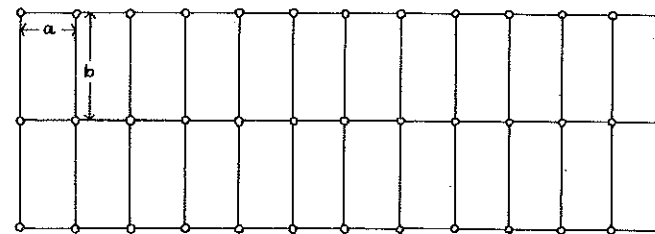

Fig. 6: Line planting or rectangular spacing method.

Planting is done in lines, where  $a$  is the distance within the line and  $b$  between the lines. This method is applicable for planting in high cogon or talahib, where the cost for strip brushing can be reduced by adopting a wider spacing between the lines and a closer spacing within the lines, e.g. 3 by 1.5 meters.

| Spacing between lines | within lines | Seedlings per ha. | Running meters to be "brushed" | Rel. cost of "brushing" |
|-----------------------|--------------|-------------------|--------------------------------|-------------------------|
| 2.0 m.                | 2.0 m.       | 2500              | 5000                           | 100 %                   |
| 2.5 m.                | 1.6 m.       | 2500              | 4000                           | 80 %                    |
| 3.0 m.                | 1.5 m.       | 2222              | 3333                           | 66 %                    |

Table 3: Relation between spacing and relative cost of "brushing".

For planting on steep slopes every other line is started the distance of  $a/2$  to the right (or left) so that the formation of straight lines running up and down the slope is avoided.

c) Equilateral spacing: This method is rarely employed in reforestation. Theoretically a possible advantage may be a better utilization of the crown space. Equilateral spacing is useful for planting hedges of two or more rows.

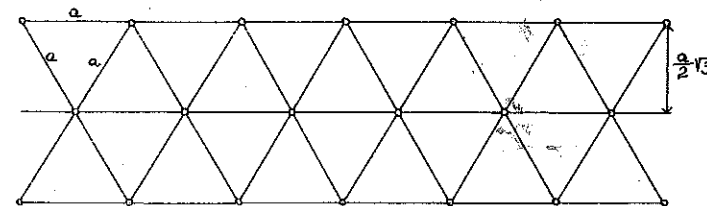

Fig. 7: Equilateral spacing

In all three of these methods of regular spacing the trees are set in straight lines. Sometimes poles are used to mark the beginnings of the lines, but generally judgement by eye is sufficient.

- d) Semi-regular spacing: Seedlings are planted in lines, but the distances are freely adjusted in case of advanced growth, rocks, fallen trees, very steep portions or other impediments. Most common in reforestation.

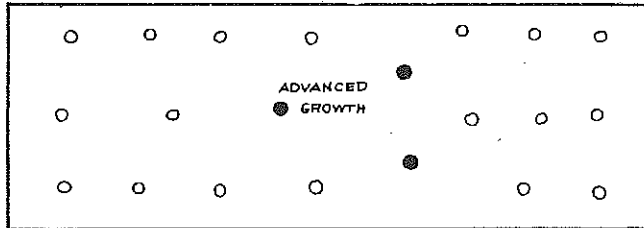

Fig. 8 Semi-regular spacing

- e) Irregular spacing: No attempt is made to plant the seedlings in lines in either direction resulting in a varied pattern of small groups and individual trees.

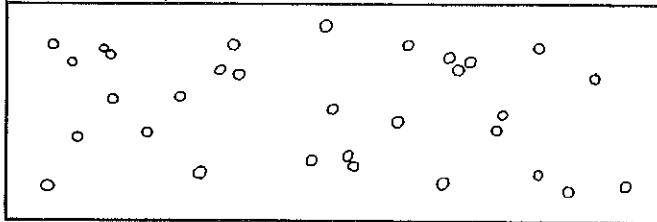

Fig. 9: Irregular spacing

This method of spacing is indicated on very rocky and rough sites, where instead of regular spacing only the most favorable micro-sites are selected for planting. Irregular spacing is also adopted in planting out small gaps. For landscaping it is mandatory because it looks more natural (64).

Generally, irregular spacing is a little difficult to obtain in practice, because the planters almost automatically tend to set the seedlings in lines. For landscaping it may therefore be necessary to mark the place for every seedling by a peg.

The main disadvantages of irregular spacing are difficulties in the organization and supervision, detecting and replanting of failures.

## Chapter 7:

### SUPERVISION AND TIMING OF REFORESTATION WORK

#### 7.1 Supervision.

For successful reforestation close supervision is essential. Under the present system of short term rotation of labor employed in many projects not too much practical knowledge and responsibility can be expected from most laborers. The foresters and foremen in charge of a reforestation project are required to spend at least some time, if not the entire day with their laborers in the field during planting to guarantee efficient work. The foremen must watch, that

- the working hours are followed strictly,
- the appointed laborers are also doing their share in the field,
- proper planting techniques are employed and holes are made deep enough,
- hauling of seedlings can keep up with planting,
- correct spacing is maintained,
- the roots of bare root seedlings are not exposed to the open longer than necessary,

- useless plants are discarded,
- the planting tools are in good working condition,
- no portion of the area is left out unless it is too steep or not suited otherwise,
- the rules for prevention of accidents are strictly followed.

The pakyaw system which means to allot a certain number of seedlings to each laborer for a day telling him, that he can go home when all are planted, has to be discouraged strongly. The results in most cases have been very disappointing. The success of planting depends too much on the quality of the work, which would suffer in that case.

#### How to organize a planting team.

- a) In ordinary field planting the available labor force is to be divided into foreman, plant hole diggers, planters, plant haulers. Where very small seedlings are to be planted, hole digging and planting is done in one operation by one man.

How many people are assigned to each particular task depends on the local conditions. Where holes are easily dug more planters than diggers have to be assigned. On difficult sites this ratio may be reversed.

In the mountains one foreman should not be given more than 12 men plus those assigned for hauling, because to supervise a greater number of men effectively on steep slopes becomes too difficult for one man alone to handle. On more or less level sites this number can be increased to a maximum of about 18 to 20.

- b) On a slope planting generally should follow the contours. To avoid accidents by falling rocks it should be arranged, that the leadman starts digging the holes on the uppermost line, the next follows on the lower line by always allowing the upper man to be one planting hole ahead. The planters follow the diggers in the same manner. With large number of laborers however, this arrangement requires a lot of discipline and is hard to enforce in practice.

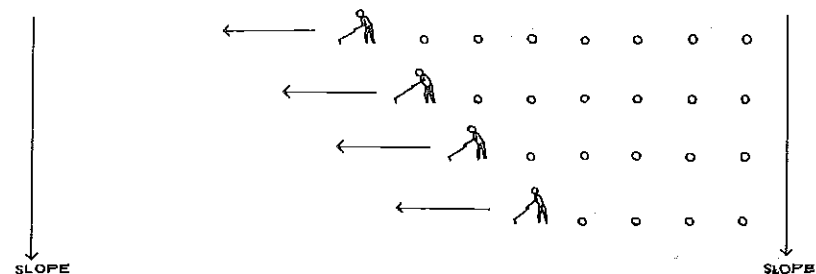

Fig. 10: Proper distribution of a small number of laborers on a slope.

- c) On very steep slopes with many loose stones and boulders it has been found safer and more practical to have all men working in one line proceeding from a contour trail directly up the slope. If no one is left behind, because he is working much slower than the others, this arrangement would be much safer, especially when a large number of people is employed. Wearing of helmets must be made obligatory for everyone working on steep slopes. Planting will follow in the same manner after digging of holes has been completed on a particular slope. For small seedlings digging and planting is done by the same man.

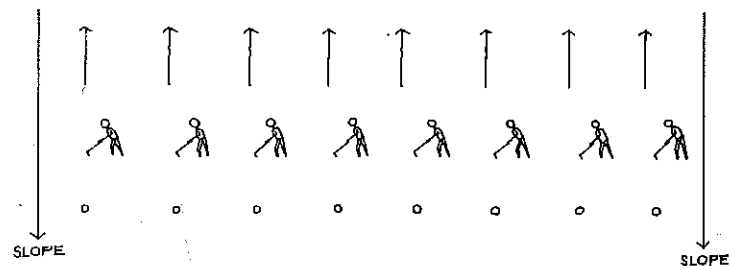

Fig. 11: Distribution of a larger number of laborers on a steep slope with many loose stones and boulders.

- d) In replanting and planting on very difficult sites it is more practical that planting is completed in one operation by the same man (one man work unit): the same person carries the container with the plants, digs the hole and sets the seedlings.

There is a general rule for everyone, who has to organize workers: always assign as few men as possible to any particular task. The more people one assigns to a job, the less will be the output per person. While some work, others will be watching only or act as entertainers. There could also be delays, because they are working dependent on each other. The maximum output per person one would get, if only one person is assigned to a particular task, provided the nature of the job does not require two or more, for instance, when the load to be carried is too heavy for one man alone. Generally three men will produce only a little more than two; if one assigns more, the output per person will generally sharply decline.

For psychological reasons it is usually preferred to have at least two persons working on a particular task, because most laborers will willingly accept any job provided they have a "c o m p a n i o n".

## 7.2 Timing of plantation work.

Another condition for successful plantations is proper timing. A time schedule based on the local climate has to be devised, which sets the date for starting and the deadline for completing each operation. This time schedule is usually drawn up in form of a bar chart. It is essential that it serves not only for decoration of the office, but is strictly followed in the field. This implies, that all necessary preparations for timely termination have to be made well in advance. The key operations, which have to be carried out at the right time, are

- a) Seed collection depending on ripening date,
- b) Collection of top soil at the beginning of the dry season,
- c) Ordering of supplies and equipment, if possible, 6 months in advance,
- d) Sowing: When selecting the optimum date the basic considerations are the time it takes to produce a plantable seedling and the beginning of the planting season. If the time needed

to produce adequate seedlings is 8 months, and field planting starts at the end of May and goes up to the end of August, sowing has to be done during October, November, and December. Seedlings sown later under these conditions will not have the size for field planting for the next planting season, and are already at the moment of sowing condemned to be "left overs".

- e) Site preparations: Under clear felling systems, where burning of felling waste is attempted, burning has to be completed before the first rains.
- f) Field planting: The optimum time to start planting is when enough rain has fallen to moisten the top 15 to 20 cm thoroughly. According to WORMALD (1969a) it is safe to start planting when the rainfall of a preceding 7 days period reaches 60 mm.  
  
Failures in plantations can be very high, when planting is done after the optimum planting time. If the seedlings get a late start, their roots will not be able to reach layers, which retain sufficient moisture during the dry season. Failures because of planting too early are usually less common.
- g) Weeding and tending operations must be carried out before the seedlings have suffered from suppression by weeds. If weeding is delayed too much, the seedlings may not be able to survive a sudden exposure and die after weeding. If weeding is totally neglected, they will die from suppression, which takes a little longer, but is also certain.
- h) Replacement of failures must be carried out at the optimum planting time, i.e. the beginning of the rainy season, before the new plantations are started.
- i) Construction of fire lines has to be carried out at the beginning of the dry season.

For the termination of each of these operations a definite period has to be fixed. Especially in planting the proper timing has to be observed strictly. In Benguet Province the optimum time is May/June to August. The survival of September plantings is already very low and can drop according to experiments to mere 20 percent.

SITE PREPARATION FOR FIELD PLANTING

To classify the various methods of site preparation, we can set up the following system:

1. Site preparation by complete removal of the vegetation
  - a) by felling and burning,
  - b) by slashing only,
2. Site preparation by partial removal of the vegetation
  - a) by clearing of strips,
  - b) by clearing of patches,

8.1 Site preparation by complete removal of the vegetation

- a) by felling and burning: Site preparation by felling and subsequent burning is practical in some cases to replace overlogged forest or secondary brush by plantations. All vegetation is cut and allowed to dry. It is burnt just before the first rains are expected. Usually this method would be too expensive, if carried out by daily paid labor. But the cost for clearing can be avoided, if there are contractors available who would clear the area free of charge in exchange for being allowed to cultivate field crops there for two or three years. After the crops have been harvested, trees can be planted (taungya system).

The main advantage of establishing a plantation on a completely cleared and burnt site are a rapid develop-

ment of the plantation, because of little competition from weeds and a good supply of plant nutrients through the ashes. The weeding expenses are generally less than in those methods, where the vegetation was only partially cleared.

The disadvantage of this method will usually be the high cost for clearing, if no taungya farmers are available who do the job free.

Some foresters object to the use of fire for clearings, but in this case the fire is employed as a silvicultural tool, which is efficient and economical at the same time. After all, the area is only burnt once before the establishment of the plantation, which will not be repeated on the same plot until the next rotation. Clearing and burning is used in many Asian countries, where teak and other valuable species which are sensitive to weed competition are planted to replace secondary brush and overlogged forests.

- b) Site preparation by slashing only, can give acceptable results, where exploitation comes to an almost complete utilization or where pure plantations are harvested. The remaining herb and brush cover is slashed to keep it down for the start of the plantation. This very simple and cheap method of site preparation can only be employed, where the natural herb and brush cover is very light, or where extremely fast growing species are planted.

Under the conditions of the Philippine rain forest, where weed growth is extremely fast, the following tree species may have a chance to compete with the weeds on a slashed site: kaatoan bangkal, bagras, Moluccan sau, binuang, and some others of fast growth. But a close watch has to be given to the plantation, which means frequent weeding and climber cutting.

8.2 Site preparation by partial removal of the vegetation

- a) by clearing of strips. This is the standard procedure in grassland planting, where the grass is more than 1 meter

high. Usually the cogon is cut on strips about 1 meter wide at intervals of 2 to 3 meters (from center to center). The plants are set on small cultivated patches (about 40 by 40 cm), on which all rhizomes have been removed.

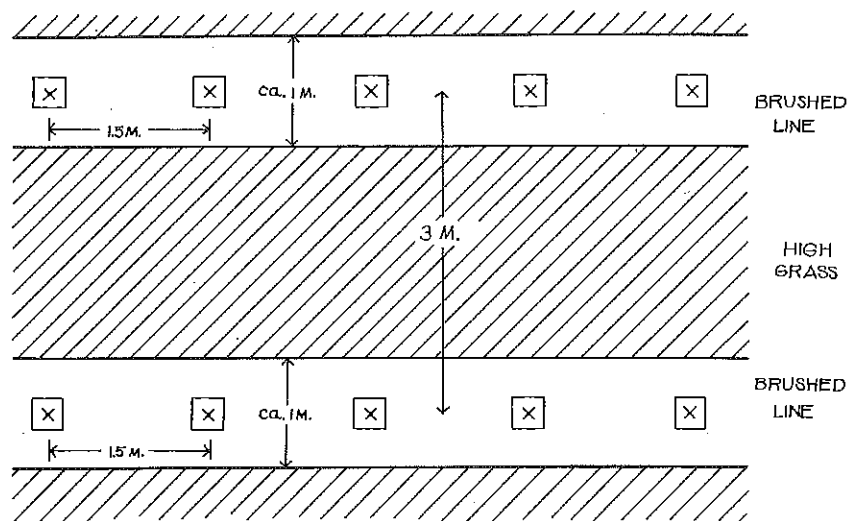

X cultivated patches, about 30-40 cm. square, on which most of the cogon rhizoms should be removed.

Fig. 12: Line brushing and spacing in high grass.

When direct seeding in grassland is attempted, it is not enough just to cut the grass, but to cultivate a strip 50 - 100 cm wide, on which the seed can be sown. Where rotary tillers are available, this strip cultivation is done by machine.

Clearing strips of forest vegetation is practiced in so-called "enrichment planting" or "line enrichment" to introduce valuable timber trees in degraded secondary brush or where natural regeneration has failed. Strips about 2-5 meters wide are cleared at intervals of 10 to 20 meters. In the remaining untouched portion only those trees are poisoned or girdled which cast heavy shade on the lines. The lines are planted with selected tall seedlings of shade tolerant species of the dipterocarp family or mahogany. For more information on this technique see Chapter 16.

b) Site preparation by clearing of patches. Clearing of patches instead of clearing lines in grassland can mean a considerable saving of labor. But it has some disadvantages. Where the grass is very tall the planters will find it very hard to move from one plot to the next. Also the supervision of the work will be greatly impeded the same applies to weeding and replanting of failures. For these reasons, under the ordinary 2 by 2 meter spacing the seedlings are planted on brushed strips. If for some reason a very wide spacing is adopted, for example 4 by 4 meters or more, then patch clearing would be indicated.

On sites, where the ground vegetation is below about 1 meter, generally no clearing or site preparation before planting is necessary. Here it is generally sufficient to uproot the grasses around the seedling with the hoe when digging the planting hole.

GENERAL CONSIDERATIONS ON TREE PLANTING TECHNIQUES

In reforestation we have to compromise usually between very elaborate methods, which may give a higher survival in the field, but are not economical, and cheap and crude methods, which may result in poor survival. Our aim must always be a successful plantation at lowest cost.

9.1 Quality and size of planting stock.

One should only use carefully selected seedlings for field planting. Plants which do not meet the requirements should remain in the nursery for some more time or be discarded. Among carefully culled seedlings there will be less failures. Beating up failures always proves to be more expensive than first planting. Usually it costs less to produce a seedling in the nursery, than to plant it in the field, especially in the mountains with long hauling distances on steep slopes. It is waste of effort and funds to plant for example pines of only 2 or 3 inches in heavy plastic containers. On difficult sites taller plants with a well developed root system show a better survival and require less weeding. They may be slightly more expensive to produce and slightly more expensive to plant, but are more economical in the long run. However, it is not only the height that matters, but also the top/root ratio and the stem diameter. Especially under a wide spacing the quality of the planting stock is of utmost importance for the future development of the stand.

For more information on desirable quality of planting stock consult Part IV.

|                         |                                           |
|-------------------------|-------------------------------------------|
| Benguet pine .....      | 9 to 12 inches                            |
| Mindoro pine .....      | 6 to 9 inches                             |
| Alnus maritima .....    | 12 to 18 inches                           |
| Teak .....              | 18 to 24 inches, cut back to 1 inch stump |
| Mahogany, bare root ... | 30 to 40 inches                           |
| potted .....            | 9 to 12 inches                            |
| Narra, bare root .....  | 30 to 40 inches                           |
| potted .....            | 9 to 12 inches                            |
| Moluccan sau .....      | 12 to 18 inches                           |
| Kaatoan bangkal .....   | 12 to 18 inches                           |
| Eucalypts .....         | 12 to 18 inches                           |
| Gmelina arborea .....   | 18 to 24 inches                           |

Table 4: Desirable height of planting stock (67).

9.2 Size of planting holes.

The planting hole must be deep enough to allow the tap root to hang down vertically without bending its tip. If the tap root is too long, it would be better to shorten it a little than to bend it. Large plants suffer more from transplant shock than smaller ones and must be planted in a way that their roots assume again their natural position, which means digging a relatively large planting hole. For small seedlings with a few and still flexible roots a small planting hole may be sufficient. Although older seedlings are growing faster when planted in a large pit, economic considerations put a limit to the size of the planting hole (64). It must be realized, however, that a large planting hole with plenty of refilled soil helps root development, results in higher initial growth, and greatly increases the survival rate especially on dry sites (64).

9.3 Depth of rooting horizon.

The seedlings must be planted in a way that the roots can reach soil layers, which retain sufficient moisture during the dry season and enable the plant to survive. This can be achieved by digging a deep planting hole and loosening the soil at the bottom of the hole to facilitate root penetration. Stones blocking the way into lower soil horizons have to be removed.



The depth where sufficient moisture is available all the year round depends not only on the climate, but also on the water holding capacity of the soil, the soil cover, the exposure and other factors.

#### 9.4 Protection of roots during planting.

One should never expose the roots of bare root seedlings to the open longer than necessary. For bare root planting this is one of the most important planting rules, perhaps more important than the planting technique itself. It has to be strictly avoided, that the roots and rootlets dry out during careless transport, prolonged and faulty storage, and badly organized and poorly supervised planting. Experiments have clearly shown, that seedlings whose roots had been exposed to the sun for only a few minutes can already be seriously affected. When planting bare root seedlings the planter has to carry the seedlings in a container especially designed to protect the roots, or he has to wrap them in wet cloth. One should never assign a plant distributor as done with potted seedlings.

#### 9.5 Correct planting depth.

When c o n i f e r o u s seedlings are planted too deep, especially in heavy soil, early growth is slow and the plant assumes a stunted appearance. The reason for this is the dormancy or death of the old roots and the development of a new root system just below the surface. Through the dead roots of the old root system a fungus might enter, which can cause the death of the tree years later (64).

However, it is recommended also for coniferous seedlings, especially in light soil to give some allowances for the soil to settle and for surface erosion around the seedlings which almost always occurs during tropical rain showers.

Most broadleaved species can be planted considerably deeper than their original position, which has the advantage, that the root system will not be exposed, if some soil is washed away by heavy rains.

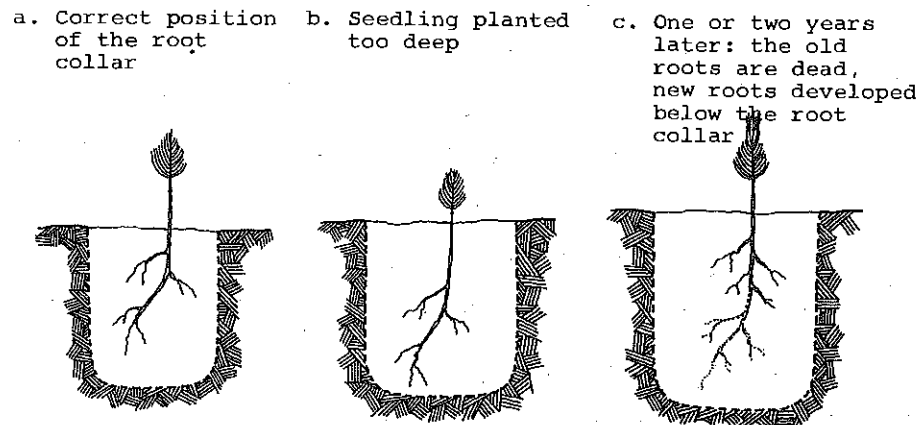

Fig. 13: The effect of deep planting (after TOUMEY & KORSTIAN, 1962)

TREE PLANTING TECHNIQUES AND TOOLS

Classification of planting methods:

1. Planting of potted seedlings,
2. Planting of bare root seedlings,
  - a) Methods, in which the plant hole is made by removing the soil from the hole and piling it up on the sides,
  - b) Methods, in which the hole is made by a thrust of a planting bar or a notching spade,
  - c) Methods, in which the soil is only lifted without digging a hole,
  - d) Fully mechanized planting with planting machines.
3. Stump planting.

10.1 Planting of potted seedlings.

Potted seedlings are raised in individual containers, which usually have to be removed before planting. The containers most in use are plastic bags, followed by boho pots, old tin cans and veneer pots.

The use of containers is little practiced in temperate countries, where mainly bare root planting stock is used in the field. All field planting in Central Europe for example is carried out during spring or autumn, when the seedlings still or already are in a resting stage. All broadleaved species are without leaves at this time, and there are hardly any transpiration losses. The young

seedlings of most tropical timber trees do not have such an absolute resting period. Therefore the best way to succeed in field planting for most species is by planting potted stock.

a) Tools

- Planting hoes: Various types of planting hoes are in use. They vary in the shape, length and width of the blade, the length of the handle, and the angle by which the blade is attached to the handle. The most universal planting tool of all the tools tested was the oval blade planting hoe (fig. 14a). It weighs about 1200 grams, the blade is reinforced by a midrib. The oval blade is to be preferred to a blade with a straight edge, because it penetrates the soil more easily without being damaged. For rocky soil also a sturdy, narrow blade with a straight edge was found useful (fig.14b), but it proved to be unsuitable for grassland with a dense mat of rhizoms.

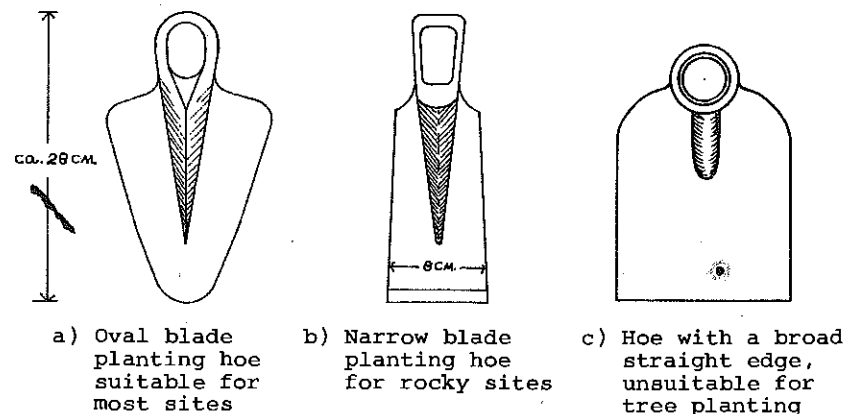
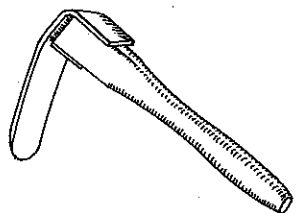

Fig. 14: Types of planting hoes.



For the planting operation itself also a light short handled planting hoe can be employed similar to the Reissinger model planting hoe used at the Training Center in Baguio. (fig. 15). All planting hoes must be sharpened from time to time with a file to keep them in optimum working condition.

Fig. 15: Reissinger model planting hoe

- Motor plant hole drillers. Most earth drillers are operated by a chainsaw motor. Therefore, where a chainsaw is available, relatively small extra expenses are involved for the purchase of the driller.

Two types are available:

Spiral drillers, ordinary type, deposits about 2/3 of the soil around the hole, sizes from 15 to 30 cm diameter (fig. 16a),

Frame drillers, the soil is only loosened and mixed, but remains in the drill hole, easier to handle than a spiral driller.

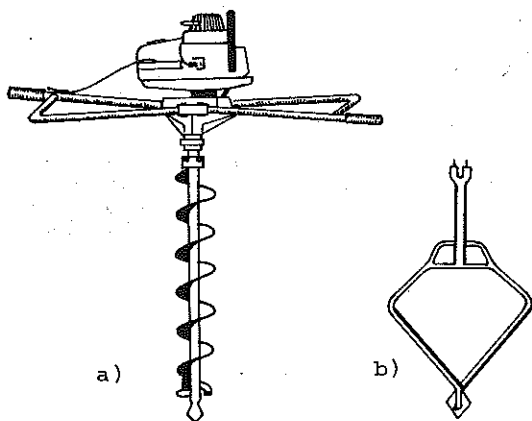

Fig. 16: Motor plant hole driller with chainsaw motor. a) spiral driller, b) frame driller.

An advantage of the motor drillers is the deep hole they produce, which helps root development and root penetration into greater depth and might increase the survival rate on dry sites. Motor drillers are also useful for setting fence posts.

A disadvantage is that their operation requires two men and is somewhat tiring without achieving significantly more than manual labor. The use of motor driller has its limitations on rocky soils and steep slopes.

- German circular spades were found useful for planting on loose forest soils without many stones. They are also suitable for lifting earth balled seedlings and wildlings.
- b) The planting technique: Just before planting, after the hole has been prepared, the seedling is removed from the container. Care is to be taken not to break up the earthball. Plastic bags can be easily torn open or cut with a small knife, after the soil has been compacted slightly by pressing it gently. Also removing the boho cylinder generally does not require any tools, because at planting time it may be disintegrating already. But when removing a seedling from a metal can without proper slits, very often the earthball breaks into pieces and the whole effect of planting potted seedlings is gone.

When placing the earthball into the planting hole the upper part of the ball should be level or slightly deeper, but never higher than the surrounding soil surface. After planting, the soil around the seedling is thoroughly tamped to fill all air spaces between the ball and the sides of the planting hole to avoid interruptions in the capillary system. Where rainfall is critical, a light depression is formed around the tree as a catchment to promote infiltration of rain water. Finally some mulch is deposited around the seedling in form of grass or litter to reduce evaporation and to avoid hardening of the top layer.

The accomplishment for planting potted seedlings per man day varies according to site condition and the size of the pots

between 100 and 150 seedlings per man, without considering the time for hauling the seedlings to the planting site.

c) Advantages and disadvantages of potted seedlings:

The main advantages are:

- potted seedlings have a higher chance of survival under adverse conditions,
- the root system is only little disturbed in the planting operation,
- planting need not to follow transport of the seedlings immediately, the seedlings can be stored for some time at the planting site, provided that they are kept under a light shade and are watered.

The disadvantages compared to bare root planting are mainly the higher costs:

- for the purchase and preparation of the containers,
- for transportation and hauling, because a considerable quantity of soil has to be transported,
- to secure good potting soil is a problem in some places and involves additional cost.

10.2 Planting of bare root seedlings.

Bare root planting is done in the Philippines with more resistant species on favorable sites. Species, that are commonly planted bare root are narra, molave, kalantas, ipil-ipil, Alnus, Para rubber. There are some species, which are often planted potted, but on favorable sites survive well as bare root seedlings such as Benguet pine (planted bare root on Mt. Data) and mahogany. For bare root planting many different tools and methods have been developed. A number of the older methods were very elaborate and are not practiced any longer. There is a tendency now towards more simplified and crude methods to make tree planting more economical with only a slight sacrifice in the survival rate. Here only those methods will be described more in detail which can be applied under Philippine conditions.

a) Planting, in which the plant hole is dug by removing the soil from the pit and piling it up on the sides.

This is the most common method for planting bare root seedlings in tropical countries. Usually planting hoes as described above are used, but also motor plant hole drillers and other implements can be employed.

Plant holes are dug at least 20 to 25 cm deep, the soil is piled on the sides without scattering it too much. The planter who follows the digger, carries enough seedlings for one line with him. The roots of the seedlings have to be covered with a moist cloth all the time. The plant is set with the help of a small planting hoe like the Reissinger Model used in the Training Center. One can also use the hands to fill back the soil and sort out green grass and stones. Afterwards the soil is tamped firmly with the heels or the back of the planting hoe.

The daily accomplishment varies according to site conditions and the size of the planting stock from 200 to 300 seedlings per man.

The planting technique using the oval blade planting hoe in combination with the Reissinger hoe appears to be the most universal planting technique for Philippine conditions. Both tools can be used for planting bare root and potted seedlings on almost any type of soil.

b) Planting methods, in which the planting hole is made by a thrust of a planting bar or a notching spade.

This group includes planting methods, in which the opening is made by thrusting an iron bar or a heavy notching spade into the ground pressing the soil to the sides and producing a cone or wedge shaped hole. After the roots of the seedlings had been inserted to the required depth, the hole is closed by a second thrust of the planting bar or with the help of a small planting hoe.

- Planting with planting bars. In many places, 6 to 7 feet long planting bars with an iron or hardwood tip, or made of solid

iron are still in use. It should be noted, that a stick for planting (digging stick) was the first agricultural tool developed by mankind and was already used in the Neolithic Age. Under special conditions this tool can be very effective and is still widely used in many tropical countries.

The original form of a planting bar is a tool similar to a spear. More developed forms have a T-handle and a foot rest to be able to use the feet when pushing the planting bar into the ground (Fig. 17) (20).

The planting bar is thrust vertically into the soil and then withdrawn. The seedling is inserted in the opening so that the roots hang downwards. The tool is thrust into the soil again in a slanting position a few inches from the original spot in a way, that the lower points of the openings come together. It is then moved forward firmly pressing the soil against the roots of the seedling. If the planting bar is not properly inserted for the second thrust, the lower part of the planting hole will remain open.

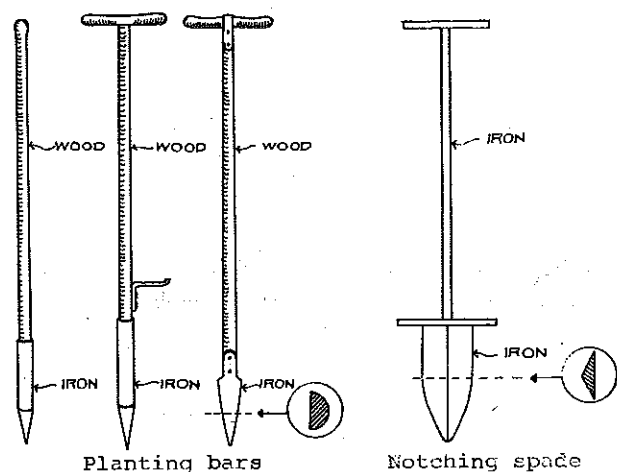

Fig. 17: Planting bars and notching spades.

This method is useful for stumps and very small seedlings and can be employed on light soils only.

- Planting with a notching spade. Tools of this kind were seen occasionally in the tool rooms of reforestation projects, but they were obviously rarely used. Several types of notching spades have been designed to overcome the small openings made by planting bars. Notching spades have a wedge shaped blade and have a weight of about 3000 grams. The spade is thrust vertically into the soil opening a v-shaped cleft. After the seedling had been inserted, the opening is closed with the foot or a second thrust of the notching spade a few inches besides the first one. With notching spades slightly larger seedlings can be planted than with planting bars. On heavy soils this method will generally be a total failure.

Under Philippine conditions the use of notching spades is not recommended, because

- the soil is compacted at all sides of the openings, which makes root penetration difficult,
- the roots are crowded together in a small hole or pressed into in a single plane, sometimes the holes are so small, that the roots may bend upwards,
- there are limitations on heavy soils and regarding the size of seedlings,
- the use of notching spades is very tiring because of their weight.

c) Planting methods, in which the soil is only lifted without digging a hole.

These methods for planting bare root seedlings have become more and more popular with foresters in Europe, after it had been realized, that even by relatively crude planting methods good results can be achieved. The two most widely used methods are: slit planting with the oval blade planting hoe and L-slit planting with the axe-hoe.

Slit planting with the oval blade planting hoe. After the vegetation had been cleared on a patch or strip the hoe is thrust to the full length of the blade into the soil. The handle is moved upwards with a light pull to create an opening

for the roots, then the handle is moved downwards to produce the slit. The worker makes a step forward, until he is able to look into the slit.

The plant is swung as deep as possible into the opening by the left hand (while the right is pressing the handle down) and pulled up, until the root collar is level with the soil surface.

The seedling is kept in this position and the handle is pivoted on the knee to move it out of the slit. Finally the soil is carefully tamped with the foot (Fig. 18 a).

It is also possible, that two men work dependent on each other (two men work unit): one is handling the hoe, the other carries the container with the seedlings, sets the plants and tamps the soil (Fig. 18 b). The achievement of the two men work unit is slightly less than that of one man working alone.



a: one man work unit,      b: two men work unit  
Fig. 18: Slit planting with the oval blade planting hoe  
(drawn after LOYCKE, 1963)

Slit planting with the oval blade planting hoe is considered to be one of the fastest planting methods for bare root seedlings on suitable sites. Under favorable conditions a man can plant 100 seedlings per hour. Trimming of the roots before planting is very important. This method can be used for seedlings up to about 25 cm above root collar. The fact that the plants are planted in a slanting position has no effect on their survival, and they will straighten up very soon.

The method can only be recommended for loose soils and relatively small seedlings, and may not be suitable for reforestation of wasteland and degraded grassland.

L-slit planting with the axe hoe. This is a further development of the ordinary slit planting technique to overcome the narrow planting holes. A special hoe with an axe blade on top had been designed for this method. The plant hole is made by one stroke of the axe followed by one of the hoe (47). In Germany this method is considered to be the most advanced and economical planting method for bare root seedlings. Under Philippine conditions the value of this method, however, appears to be doubtful, and therefore it is not described here in detail.

#### d) Fully mechanized planting with planting machines.

Up to now fully mechanized planting has no application in the Philippines and is mentioned here only to complete the list of bare root planting techniques.

The machines developed for this purpose are generally drawn by a tractor. A plough opens a furrow, into which the plants are set by a device, which regulates the spacing. The only manual labor required is to feed the seedlings into this spacing device. After the plants have been set, the furrow is closed by two plough blades or two wheels with tilted axles passing along both sides of the furrow pressing the soil firmly against the roots of the seedling.

Planting machines can operate only on more or less level ground with not too many impediments. A well known planting machine is the FINNFORESTER, which under average conditions can plant about 4,500 seedlings per day, under favorable conditions up to 12,000.

#### 10.3 Stump planting.

Planting of stumps is only known in tropical countries. With some species a higher survival rate can be expected from stumps than from bare root seedlings (7). The main reason for the

success of stump planting is the reduction of transpiration losses by removal of the shoot.

A stump is produced from a seedling 2 to 3 feet high. After lifting the plant from the nursery bed the stem is cut 1 inch above the root collar. Tap root and side roots are also shortened. The length of the stem portion retained has no effect on the growth. With long stumps, however, there is a tendency to produce more than one shoot. A diameter between 12 and 15 mm is generally considered the optimum for teak stumps. For *Gmelina arborea* LAMB (1973) recommends 12 - 25 mm diameter at root collar with one foot of the tap root and 3-5 cm of the shoot left.

When the stump is too thin, it has only little reserves and only a short shoot is produced. All stump planting should be carried out just before or right after the beginning of the rainy season, so that the plants are well established, when the dry months start.

For planting stumps very crude planting techniques can be used, and very often only a pointed stick or a planting bar is employed. When planting with a hoe, the slit method is generally adequate.

On burnt over areas where no further site preparations are required a man can plant 100 stumps per hour. In grassland where the rhizoms have to be removed, the average achievement is only 30 to 35 stumps per hour without the time needed for strip brushing.

The main advantages of stump planting are

- Reduction of transpiration losses,
- Stumps are easy to transport,
- Storage for a week or so is possible without harm,
- They are cheap to plant, because crude planting techniques can be employed,
- Stumps can already be planted just before the rainy season,
- For some species survival of stump planting is higher than bare root planting.

Species, that successfully can be planted by stumps include according to LETOURNEUX (1957) *Tectona grandis*, *Gmelina arborea*,

*Lagerstroemia speciosa*, *Albizia procera*, *Alstonia scholaris*, *Cassia fistula*, *Cassia siamea*, and others. In the Philippines only stump planting of teak and in a few projects of *Gmelina arborea* is popular, but experiments are recommended for stump planting of other species.

#### Chapter 11:

#### PLANTING OF WILDLINGS

Planting of wildlings is practiced with species, which are difficult to raise in nurseries, because their seeds have only a very short viability. Species often planted as wildlings include *almaciga* (*Agathis alba*), and dipterocarps as white lauan (*Pentacme contorta*), *bagtikan* (*Parashorea plicata*), *Mayapis* (*Shorea squamata*) and others.

The following practice is recommended: the seedlings are lifted with a ball of earth and potted on the spot in the forest. They are then kept in a temporary nursery under light shade for recovery for 3 to 6 months, before they are planted in the field.

Even with proper techniques the survival of dipterocarp wildlings usually is not very high. There are casualties when the wildlings are potted, and then later when they are planted in the field.

An overall survival of only 50 percent is not uncommon. From experiences in Malaysia it appears, that younger wildlings show a better survival rate than older ones. However, they should not be potted before the cotyledons have fallen. The optimum time for potting is when the first real pair of leaves has fully developed. If the wildlings are too old, they will suffer from the transplant shock and mortality will be very high after potting.

| Bagtikan ( <i>Parashorea plicata</i> ) |          | White Lauan ( <i>Pentacme contorta</i> ) |          |
|----------------------------------------|----------|------------------------------------------|----------|
| Height of wildling                     | Survival | Height of wildling                       | Survival |
| 0 - 20 cm                              | 88 %     | 0 - 20 cm                                | 56 %     |
| 20 - 40 cm                             | 74 %     | 20 - 40 cm                               | 52 %     |
| 40 - 60 cm                             | 74 %     | 40 - 60 cm                               | 24 %     |
| 60 - 80 cm                             | 66 %     | 60 - 80 cm                               | 10 %     |
| 80 - 100 cm                            | 40 %     | 80 - 100 cm                              | 2 %      |

Tab. 5: The survival of directly transplanted dipterocarp wildlings of different size classes. The plants were mud-puddled and stored for one week before planting (MAURICIO, 1957).

The wildlings should be transplanted to the field, before they have reached a height of about 40 cm. If they are taller, the rate of survival drops sharply as experiments with white lauan and bagtikan have shown (50).

Planting of dipterocarp wildlings has justification in enrichment plantings, where the following rotation may be based on natural regeneration again. If planting of wildlings is considered on a large scale, it would be worthwhile to clear the ground vegetation and do some soil working under selected mother trees, just before the seed falls. In many cases the regeneration will spring up as dense as in a nursery seed bed. This method gave excellent results in Java for the regeneration of Agathis loranthifolia.

## Chapter 12:

### DIRECT SEEDING

Direct seeding is the oldest method of artificial regeneration and was practiced as early as the 14th century by the "fir sowers of Nuremberg" (Bavaria), the first historical record of artificial regeneration of forest trees. Later direct seeding had been more and more replaced by planting which for most species gives better results. But there are still a number of species, which are easily propagated by direct seeding because they

- produce plenty of seeds,
- grow fast in the early stages,
- have large seeds with plenty of reserves,
- produce a long tap root at an early age,
- have seeds with a high germinative capacity, that can be maintained well under ordinary conditions.

Species, which have been successfully established in the Philippines by direct seeding, include ipil-ipil, lumbang, bagilumbang, akleng-parang, casoi, teak and *Cassia siamea*.

#### Methods of direct seeding:

- Sowing on cultivated patches 1 to 3 feet in diameter is applicable for larger seeds, which are sown at a wider spacing e.g. lumbang, casoi.
- Sowing on cultivated strips 2 to 4 feet wide is usually practiced with finer seeds such as ipil-ipil, which are sown more densely
- Broadcasting the seed without soil working gives good results only under very favorable conditions (moist sites, loose soil, not too much ground vegetation). There is a possibility, that



the seeds are already intercepted by the grasses and do not even reach the ground.

- Broadcasting the seeds from planes can be successful only under very favorable conditions.

Generally direct seeding gives acceptable results only, when soil working was carried out to facilitate root penetration. It is also important, that the seeds are covered with a soil layer 1 to 2 times the thickness of the seed and, if possible, with a light mulch. To ensure establishment during the rainy season, direct sowing must be carried out at the very beginning of the rains, so that the seedlings are already strong enough to survive the heavy monsoon rain later in the year. The success depends on so many unforeseen factors, that it is strongly recommended to conduct small scale experiments first before embarking in any larger operation.

The quantity of seed needed can be estimated from the number of viable seeds per pound, but ample allowance has to be given for losses through birds, rodents and insects. In the Los Baños area 7 to 8 gantas of ipil-ipil seed are sown per hectare (1 ganta = 3 liters).

There are some chemicals available to treat the seeds before sowing to make the seed less attractive to rats and birds or even poisonous like red lead powder (1 kg. red lead powder for 8 kg of seed).

To insure even distribution of seeds, the quantity of seeds for one line across the area must be measured in a tin can or similar container as a guide.

#### Advantages of direct seeding:

- For direct seeding no nurseries are required.
- Direct seeding is more flexible, it does not depend on the availability of nursery stock.
- The shock of transplanting is avoided.
- Species, which produce a long tap root at an early stage, are generally difficult to transplant. Direct seeding is likely to

give better results in those cases.

- Due to a greater density in direct seeding (if successful), the quality of the future timber stand may be better.

#### Disadvantages of direct seeding:

- Sometimes the total costs of establishment are higher than planting, because of higher weeding expenses. The initial cost may be lower, but the total cost of establishment must include also weeding expenses, which in direct seeding can be very high.
- Poor survival of seedlings, if conditions are not very favorable, because they cannot be watered as in a nursery. If the seedlings cannot reach soil layers, which keep sufficient moisture during the dry season, an initial success may turn into a complete failure.
- Many of the seeds and young seedlings become victims of rodents, birds and insects, from which they could be protected in the nursery.
- The success is very uncertain, because it depends on many unpredictable factors.

REPLACEMENT OF FAILURES

Even with most careful planting techniques there will always be a number of seedlings, which do not survive. Causes of death can be

- injuries from transport,
- unforeseen dry spell after planting,
- damage by insects or rodents,
- improper planting techniques,
- suppression by weeds,
- poor quality of planting stock,
- trampling by livestock,
- effect of dry season.

Replanting or "beating up" such failures is always more expensive than first planting. The cost per seedling may double or triple. Therefore it is necessary to decide carefully, whether replanting is required or not based on a small sampling check to estimate the failure.

As a very crude guide for sampling it is suggested, that in areas below 2 hectares every 5th line, and above 2 hectares every 10th line is sampled. It is advisable to use two counting machines: one marked "survival", the other "failure". If counting machines are not available, the results can be recorded on tally sheets by dots and lines:

1 2 3 4 5 6 7 8 9 10  
 . : .. :. :. :. :. :. :. :. :.

Example:

| Line No. | Survivors | Failures |
|----------|-----------|----------|
| 2        | ☒☒☒☒☒☒:.  | ☐ 8      |
| 7        | ☒☒☒☒☒☒☒   | :: 4     |
| 12       | ☒☒☒☒☒☒☒☒  | ☒ 9      |
| 17       | ☒☒☒☒☒!:   | ☒: 13    |
| 22       | ☒☒☒☒☒☒☐   | ☒ 10     |
| 27       | ☒☒☒☒☒☒☒:. | :: 3     |
| Total    | 376       | + 47=423 |

$$\frac{47 \times 100}{423} = 11 \% \text{ failure}$$

Replacement will be necessary only, if the overall percentage of failure is above 20 percent, but only where at least two successive seedlings have failed. If the overall rate of failure is below 20 percent, replanting will be carried out only where the failures are heavily concentrated (see tally sheet).

For replanting, the best available seedlings are selected and planted at the beginning of the rainy season, at the optimum planting time.

To avoid, that unnecessary time is spent in walking and searching, all operations of replanting are done by the same man (one man work unit):

- detecting the failure,
- digging a new planting hole,
- planting the seedling.

There may be need for more than one replanting on the same area during the first years of the plantation. But where after two replanting operations the area still is not adequately stocked, the planting procedures should be revised for improvements, or another species must be chosen for the site.

REFORESTATION OF ADVERSE SITES

The areas provided for reforestation generally are those sites, which are not fit or not wanted or agriculture. For obvious reasons the production of food is given priority to forestry. Only in very rare cases the site offers ideal conditions for tree planting. Most sites allotted for reforestation are adverse in one or the other respect, which may include:

- dry sites or adverse southern exposure
- rocky and shallow soils
- coastal sands
- swampy sites
- steep slopes
- high cogon or talahib

14.1 Dry sites and adverse southern exposure.

Difficult sites of this sort can be encountered in almost every reforestation project in the Philippines. The most important rules for planting on a dry site are:

- a) On dry sites potted plants generally give better results than bare root seedlings. The pot size for dry sites should be as large as possible to provide a good start for the seedling.
- b) The planting stock should be of the best available quality, that means that only seedlings of optimum size with a well developed root system are to be planted. The root system must be able to reach layers, which retain sufficient moisture during the dry season.

- c) On dry sites it is very important, that a large and deep planting hole is prepared with plenty of refilled soil to stimulate the root development and facilitate root penetration into deeper soil layers.
- d) Where rainfall is scarce, it may be of advantage to form a basin around the seedling to catch as much water as possible. In humid areas the formation of such a basin might lead to accumulation of water and cause the death of the seedling for lack of oxygen at the roots.
- e) On tall broadleaved species young sappy shoots and part of the foliage must be trimmed to reduce transpiration, until the seedling is well established. Heavy transpiration losses otherwise can lead to the death of the seedling.
- f) Mulching with grass or leaves greatly reduces evaporation from the soil surface around the seedling and prevents hardening of the surface soil.
- g) In extreme cases delicate and newly planted seedlings are shaded by fern fronds and branches to prevent heavy transpiration.
- h) It is essential on dry sites that planting is carried out at the beginning of the rainy season, which is the optimum planting time.

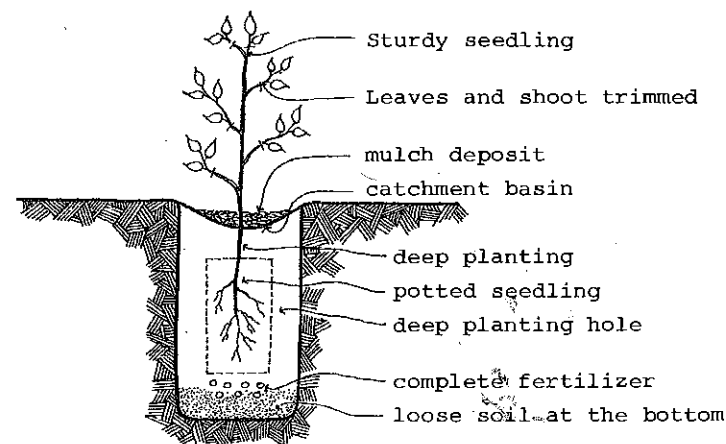

Fig. 19: Planting technique for dry sites.

- i) Application of a table spoon of complete fertilizer containing nitrogen, phosphorus and potassium has a very positive effect on the development and the draught resistance of the seedling.

#### 14.2 Rocky sites.

Very often the nature of the site is the result of erosion. Sometimes only the topsoil is washed away, sometimes the subsoil has gone too, leaving an almost bare rock behind. Some soil might still remain in the cracks between the boulders. The possibilities for planting depend very much on the nature of the underlying rock, the exposure, the gradient and the climate. Some sites appearing impossible at the first glance, may have some cracks and soil pockets able to support trees. Very often the site appears more rocky than it really is because of the many stones accumulated on the surface after the soil has been washed away. Only by local experience it can be judged, whether the site would be able to support trees (15).

Where subsoil is left, contour trenching may be helpful in reducing run-off and increasing infiltration of rain water. Instead of regular spacing the seedlings are set on the best available spots. When the plant hole is refilled all stones must be sorted out. On an extremely degraded site application of a table spoon of complete fertilizer would provide a good start for the seedlings.

#### 14.3 Coastal sands.

There are very few species, which can be considered for planting on coastal sands. The most suitable species seem to be agoho (*Casuarina equisetifolia*), talisai (*Terminalia catappa*), aroma (*Acacia farnesiana*) and the rather slow growing bitaog (*Calophyllum inophyllum*). Only tall plants at least 50 cm high should be used. They are planted in large and deep planting holes with some good soil as refill. Around the tree a deep basin has to be formed to catch as much rain water as possible. It is important, that planting is done

right at the beginning of the rainy season. Where it is possible, a weekly watering of about 5 liters per plant during the first dry season would greatly increase the survival of the seedlings on coastal sands.

#### 14.4 Swampy sites.

Planting is done on mounds or ridges to minimize the period during which the seedlings are submerged during floods and to improve the aeration of the root system. Species to be considered for swampy sites are banaba (*Lagerstroemia speciosa*) and *Eucalyptus robusta* (Austr. "Swamp mahogany"), and *Casuarina glauca*.

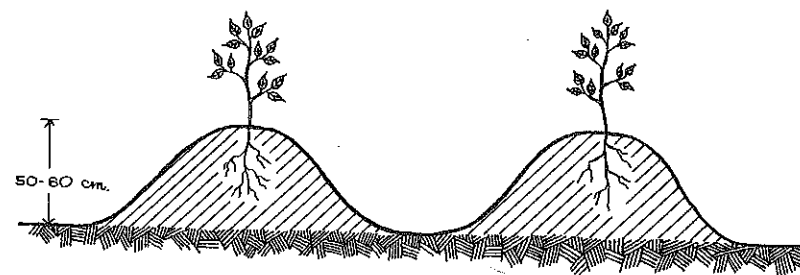

Fig. 20: Planting on a swampy site

The most favorable planting time for very wet and swampy sites which are submerged during the rainy season would be the end of the rains, so that the seedlings are well established before the next wet season starts.

#### 14.5 Steep slopes.

On steep slopes a small horizontal platform has to be prepared where the planting hole will be dug (see fig. 23, below).

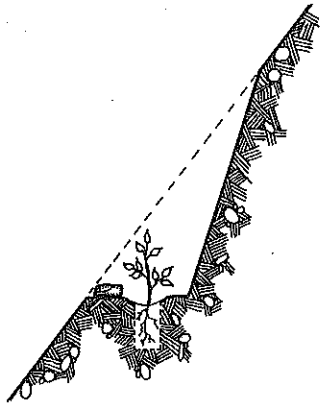

Fig. 21: Planting on a steep slope

In extreme cases safety ropes have to be used, which are tied around the waist of the planters. To avoid accidents from falling stones, the laborers should not be allowed to work one below the other and wear helmets. The one working above must be always one planting hole ahead (See also chapter on supervision and organization).

#### 14.6 Planting in high grass.

Where the grass cover does not reach more than two or three feet, planting is not very difficult. In high grass the seedlings are usually planted on cleared strips. For each individual plant a small patch of about 50 cm in diameter is hoed and as many rhizomes as possible are removed before planting. The success of the plantation depends to a high degree on subsequent weeding.

To reduce the weeding expenses on cogon land, only tall plants should be used. The application of complete fertilizer (one table spoon per seedling) would not add too much to the cost of the plantation, but helps to overcome the weed competition.

To save costs for line cutting, it is recommended to adopt a wider spacing between the lines than within the lines. BARNARD (1956) even recommends spacing between the lines double the distance within the lines. A 1.5 x 3.0 m spacing would amount to 2222 seedlings per hectare as compared to 2500 seedlings under 2 x 2 m spacing.

## Chapter 15:

### TAUNGYA PLANTATIONS, A POSSIBLE SOLUTION OF THE KAINGIN PROBLEM

#### 15.1 Forms of the taungya system.

The word "taungya" originally in Burmese means "field in the hills" or in Philippine language a kaingin. When BRANDIS, a German botanist and forester employed in the Indian Forest Service, saw the vast Imperata areas created by the hill tribes in Burma through shifting cultivation, he started a scheme to turn them into teak plantations. The tribal people were given a piece of land and were allowed to clear and to cultivate it for two years. The only condition was, that before abandoning the plot they had to plant it with teak stumps provided by the Forest Department (35).

This was about 100 years ago. The original form of taungya has been improved and the term taungya is now known all over the tropics as a combination of agriculture and forestry. The principles of taungya farming are still the same as a century ago, when it started in Burma. A certain area, generally situated in a forest reserve, is allotted to individual families. The farmers are allowed to cut, burn and cultivate the land under the limitations stipulated in the taungya agreement. The trees are planted either in the first or second year or after all agricultural crops have been harvested. Important is that the trees are planted before the area has turned into grassland. In places of acute land shortage, the farmers may even accept to weed the plantation during the first year.

Today taungya is widespread in Africa, India and some countries in Southeast Asia. In the Philippines a modification of taungya on a voluntary basis is practiced at the tree farming projects of the PAPER INDUSTRIES CORPORATION OF THE PHILIPPINES (PICOP) at Bislig, Mindanao. Farmers who have titled land of at least 10 hectares within 100 kilometers of the paper mill can participate in the project. "The scheme is to devote 20 % of the farmers total landholding to food and livestock production and the remaining 80% to fast growing, shortrotation pulpwood trees. Intercropping of food crops between the newly planted trees can also be done to provide supplemental food or cash income" (PICOP information pamphlet 1974). The paper mill with a daily capacity of 430 t guaranties to buy all the pulpwood at prevailing market prices. The Development Bank of the Philippines is granting loans of ₱ 1000.- per hectare for the development of the free farms. The main species planted so far is Albizzia falcata, managed under an 8 years rotation. The seedlings are provided by the company at a cost of ₱0.10 at nursery site or ₱ 0.15 at plantation site, and have to be paid for when the first pulpwood is sold.

Another special form of taungya is reported from the Zambales Mountains, where according to Director JOSE VIADO the Aetas are allowed to clear and cultivate a patch of forest under the condition, that they plant it afterwards with Lumbang (Aleurites moluccana). The BUREAU OF FOREST DEVELOPMENT guaranties the Aetas to buy all the Lumbang nuts they harvest from their "own" trees. For this reason it is also within the interest of the Aetas to protect the stands.

#### 15.2 Conditions for successful taungya

- a) Land shortage. There has to be a certain land hunger, only then the farmers will accept the limitations imposed on their usual kaingin practice by the taungya agreement. In very densely populated areas the forest authorities have a very strong position, and the farmers may be willing in addition to planting and tending the trees to pay

a certain amount for the use of the land. In other parts the forest department may have to pay a substantial premium for a successful plantation to stimulate the farmers interest in the trees. In very thinly populated areas it may be impossible to find taungya farmers at all.

- b) Legal basis. The second condition for successful taungya is a suitable legal basis. It is quite possible -and has happened often before- that a group of people had been given an area for clearing and cultivation under a taungya agreement, and later refused to abandon the land claiming it as their own. They may find the help of a local politician to support their case. It is essential therefore that any taungya agreement is based on a written contract. Even then there is the danger, that land, which has proved to be suitable for agriculture, will be claimed as "alienable and disposable".

#### 15.3 The taungya agreement

The following items among others have to be reglemented in a taungya contract:

- a) Duration of the agricultural period. Under normal conditions this period should not be extended beyond two years. Otherwise the soil will be depleted of plant nutrients too much and the growth of the trees will be retarded. In drier areas, where the soil is not so heavily leached, three years may be permissible, if the farmers refuse to sign for two years only. Farmers, who are used to cultivate the soil until it is completely exhausted, often would refuse to abandon the area after two years, if this was not fixed in the contract.
- b) Planting and treatment of the trees has to be reglemented in detail in the agreement, because naturally the farmers have not the least interest in a successful tree plantation. They might even cut back the trees where they interfere with their crops. It has to be decided, if the trees are to be planted in the first or second year, or

or after the field crops have been harvested. Also the spacing of the seedlings has to be subject of the contract, and weeding during the first year.

- c) The kind of field crop the farmer is allowed to cultivate has to be made part of the contract. If the trees are planted together with the field crops, those crops which because of their size would suppress the seedlings as sugar cane, maize or cassava have to be limited or forbidden. A limitation would be, if a certain distance between the rows or individual plants is prescribed. There are also crops, which might promote diseases of the trees. It had been observed, that pines planted on old fields, where root crops like cassava had been cultivated before, suffered severely from heart rot.
- d) The size of the lot for each family has to be settled, which depends also on how far the farmers have other sources of income. According to several investigations in normal kaingin practice the area cultivated annually is only 0.2 to 0.3 hectares per head. A family of five cultivated only an average of 1.0 to 1.5 hectares, as long as only subsistence farming is practiced. Since only manual labor is employed in kaingin making, the area the farmer can cope with has a definite limit. On steep slopes 0.3 hectares may be the absolute maximum, while under very favorable conditions the farmer may be able to manage 0.5 hectares. In planning a taungya project 0.3 hectares per working person may be a safe figure to start with.
- e) Reglementation of fees, premiums and penalties. To avoid, that any feeling of ownership develops, it is desirable, that the farmer pays at least a nominal fee for the utilization of the land. But there may be also cases, where the forester has to pay the farmer for planting the trees.

Very important is a premium for a successful plantation to stimulate the farmers interest in the trees. Also penalties for bad planting or damaging the trees on purposes have to be made part of the contract. The hardest penalty would be the exclusion of the farmer from any future taungya planting.

For the utilization of fuelwood in connection with taungya it is advisable to ask the farmer to pay a nominal fee to avoid that forest rights would develop.

#### 15.4 Some common agricultural crops suitable for taungya planting (35).

- a) Upland rice is a typical crop of the Asian kainginero. In contrast to the irrigated or wet rice it is cultivated in kaingins, and is the staple crop in the less developed parts of the Philippines. Upland rice is grown for example by the Mangyans of Mindoro, the Ilongots of Nueva Vizcaya or some hill tribes of Mindanao. Both, the wet and the dry rice, are varieties of *Oryza sativa*. The yield of upland rice is much less than what is obtained from the varieties grown in irrigated fields.

Upland rice is more demanding regarding the soil fertility than corn or cassava. Therefore a fresh kaingin gives only about two consecutive harvests of rice, then it must be abandoned or planted with a less demanding crop like cassava or camote.

For taungya planting upland rice is very suitable, because it does not reach the height of most other crops.

- b) Maize or corn is a crop cultivated already in ancient times by Central American Indians. Numerous breeds of maize are now cultivated all over the tropics and subtropics, and the southern part of the temperate zone. Because of its size, planting of maize has to be restricted in taungya plantations, wherever it is planted together with the tree seedlings. A distance of at least 1.5 meters from the seedlings is to be maintained which means that the lines of maize must be at a minimum 3 meters apart.
- c) Camote or sweet potatoe (*Ipomoea batatas*) can be cultivated from moderate altitudes onwards up to 1500 meters or higher. Propagation is by cuttings, which are planted during moist weather conditions. The tubers mature after 4-5 months, when the leaves turn yellow.

Camote is suitable for taungya planting provided care is taken, that the creepers do not suppress the seedlings.

- d) Cassava (Manihot utilissima) is a member of the Euphorbiaceae and had been introduced from South America, where more than hundred varieties of this species are cultivated. Some of these varieties contain prussic acid, which has to be removed by washing the pulp before preparation of the cassava meal. The non-poisonous varieties can be prepared the same as camote.

Propagation of cassava is by stem cuttings. Also in exceptionally dry years it gives adequate yield and is able to grow on very poor soils, which have been depleted of plant nutrients by previous cultivation. The experienced kainginero therefore plants cassava at the end of the agricultural period, while during the first and second year more demanding crops like upland rice or maize are planted.

The tubers mature 6-12 months after planting according to variety and can remain in the field for some years to form a reserve for times of starvation. In spite of the many advantages for the farmer, there are some objections against the use of cassava in taungya plantations:

- cassava grows very fast and may suppress the seedlings,
- it depletes the soil of nutrients more than any other crop,
- the tubers are loosely arranged around the stems, digging them up might destroy the seedlings,
- it was observed, that cassava will promote the attack of heart rot (*Fomes annosus*), if associated with conifers.

The disadvantages can be minimized, if some restrictions in the taungya contract limit planting of cassava. For example: prescribing a late time for planting (second year) and allow only a wide spacing (3 meters) or restricting it to the outer border of the plot only. By planting fast growing tree species like *Gmelina arborea* suppression of the seedlings can be avoided.

- e) Gabi or Taro (Colocasia esculenta) is a herbaceous plant with large arrow shaped leaves belonging to the family of Araceae. This plant is commonly cultivated all over South East Asia.

As the hygromorphic habit already suggests, gabi requires moist site conditions. The plant is shade tolerant and can grow under a canopy of trees. If not planted too dense, it may be a suitable taungya crop. At a later stage it may even benefit from the shade of the trees.

There are many more crops suitable for taungya planting. What restricts their use is mainly their size and dense foliage by which the plants suppress the tree seedlings.

#### 15.5 Planning and organization of taungya projects.

Taungya on a large scale requires very careful planning, because the forester-in-charge carries a great deal of responsibility for the well-being of the families concerned. It is advisable to start at a small scale with some selected and reliable farmers from the casual labor force, who usually are kaingineros anyhow. There must be field staff available with sufficient authority to control the limitations imposed by the taungya agreement. The field staff is also responsible for the distribution of the plots for each individual family and the demarkation of boundaries. Complaints will generally arise from those farmers, who get less favorable sites. It is therefore necessary to study the area carefully before making the subdivision. After enough local experience had been obtained with a few farmers, the project can be expanded.

According to FAO (Technical Report No. 9, 1971) in the Philippines 80,000 hectares of forest land are destroyed by kaingin annually which involves about 120,000 families. If only a portion of these farmers can be engaged in a taungya agreement, the area reforested annually could be increased significantly.



IMPROVEMENT OF OVERLOGGED AREAS BY ENRICHMENT PLANTING

Enrichment planting means the introduction of valuable species in forest areas, where economical species are lacking. The long term goal of enrichment planting often is to improve the species composition in a way, that natural regeneration methods can be adopted in the next rotation. The methods of enrichment planting had been developed by French foresters (14) and are extensively practiced in the former French overseas territories in West Africa and Indochina.

Areas to be considered for enrichment planting include:

- Overlogged areas, where seedbearers as well as regeneration of economical species are absent or inadequate. If regeneration is sufficient or not has to be determined by diagnostic sampling methods.
- Secondary forest after shifting cultivation, where there is usually only a low proportion of desirables in the earlier stages of the succession.
- Areas naturally poor in desirable species, but with a potential for valuable timber trees.

16.1 Methods of enrichment planting

The common form of enrichment practiced today is line enrichment. Enrichment by irregularly spaced groups had been abandoned because of difficulties in control and retracing the groups for tending operations.

When conducting enrichment planting over extensive tracts of rain forest, not always an experienced forester can be on the

spot. It is essential therefore to issue clear and simple instructions to the workers, which can be followed mechanically.

Several modifications of line enrichment had been carried out with success (16) of which only two will be discussed below.

a) Line enrichment with shade tolerant species.

At intervals of 10-20 meters strips 2 meters wide are cleared of all vegetation. Larger trees on these strips are poisoned with sodium arsenite or a hormone arboricide (2,4,5-T). All desirables are spared. For most favorable light conditions it is recommended, that the lines run in East-West direction.

On both sides of the 2 meter strip the lower stratum, which includes trees up to about 15 meters, is felled by chainsaw or poisoned in a zone 5 meters wide. In the middle stratum (trees of 15 to 25 m approximately) only occasionally a tree with exceptionally dense foliage is poisoned or girdled.

If a distance of 20 meters between the lines (from center to center) is adopted, there still remains a zone of 8 meters of untouched forest inbetween. For more intensive enrichment it can be considered to reduce the distance between the lines to 15 or even 10 meters, so that the untouched 8 m zone in the center will be omitted.

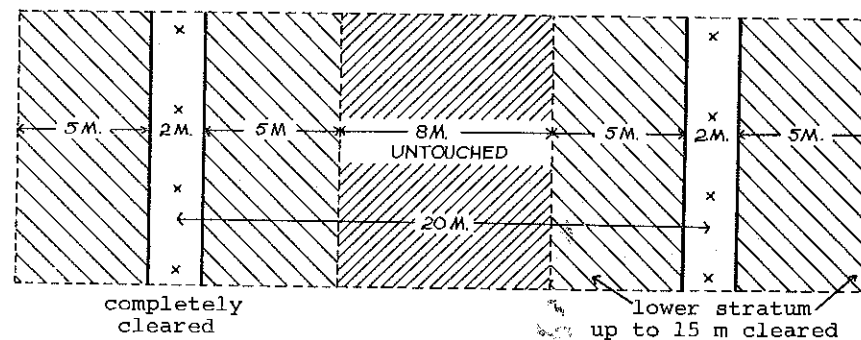

Fig. 22: Line enrichment with shade tolerant species.

Planting is done on lines at a spacing of 3 to 5 meters according to species and size of planting stock. This amounts to 100 - 165 plants per hectare.

This modification of line enrichment is recommended to be tried with dipterocarps, which require partial shade during their early stages. The high shade provided by the taller trees in the 5 meters zone on both sides of the lines will also help to reduce the growth of the weed species and climbers.

b) Line enrichment with light demanding species.

For the light demanding species of the Meliaceae family like mahogany the first method would not provide enough light, and CATINOT (1965) suggests the following modification:

All vegetation is cleared on lines 5 meters wide at intervals of 20 meters from center to center. In the remaining zone between the lines all trees higher than 15 meters (which roughly corresponds to a dbh of 15 cm) are cut, girdled or poisoned, except the desirables.

While in the first method mainly the understorey is removed, in the second modification more light is obtained by removing the higher trees. For more intensive enrichment the distance between the lines can be reduced to 10 m.

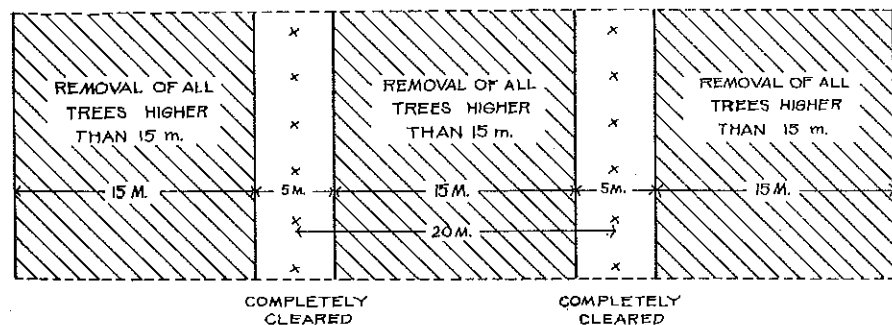

Fig. 23: Line enrichment with light demanding species.

16.2 Planting stock and suitable species.

A species, which has already proved its value in enrichment planting, is mahogany (*Swietenia macrophylla*). Since it is also one of the most successful reforestation species in the Philippines, it should be given preference where the shoot borer permits its cultivation (FAO, 1970).

The dipterocarps are more problematic, because of the short viability of their seed and sometimes poor survival, when transplanted. With improved techniques these difficulties may be overcome. Successful line enrichment with dipterocarps on an experimental scale can be seen in the concession area of the Bislig Bay Lumber Company in Mindanao. Of the large number of dipterocarps only the faster growing species like Bagtikan (*Parashorea plicata*), White Lauan (*Pentacme contorta*), Apitong (*Dipterocarpus grandiflorus*), Mayapis (*Shorea squamata*) and others are recommended.

Because of the small number of plants, these must be of the best quality available, balled or potted. Saplings or stripplings have an advantage over the weeds because of their size. But tall balled wildlings taken directly from the forest generally suffer too much from the transplant shock and generally show poor survival rates.

The best method is to collect the dipterocarp wildlings with a small ball of soil right after the first true pair of leaves has developed. They are potted and then kept in a nursery under partial shade, until they have reached planting size.

Since the number of plants is only 100 to 165 per hectare, it would add very little to the costs to apply some complete fertilizer (12/24/12 or 14/14/14) by mixing it with the soil of the planting hole. A small quantity of 20 to 30 grams per tree according to size would have a great effect on the initial growth and enable the seedlings to cope better with the rapidly developing weed species. From observations it appears, that fertilizer application also would enable the trees to put on good growth, even if the light conditions are not very favorable.

### 16.3 Tending operations.

The most decisive factor for the success of line enrichment are the tending operations during the first 5 or 6 years:

- weed control, especially during the first two years,
- poison girdling of all undesirable trees overtopping the lines, especially when the seedlings become older and more light demanding,
- systematic cutting and poisoning of undesirable secondary vegetation on the lines,
- climber cutting whenever necessary.

It is absolutely essential, that the required funds for these tending operations are guaranteed at the time of planting, otherwise the funds spent for the establishment are spent in vain. Here lies one of the most common reasons for the failure of enrichment planting.

For the removal of undesirable tree growth the use of chemicals is now a well established procedure in tropical silviculture (28,70). There is the choice between the very poisonous, but highly effective and cheap sodium arsenite and the non-toxic hormon based weed killer 2,4,5-T (For more information on arboricides consult Chapter 18.3).

### 16.4 The cost of line enrichment.

The cost of line enrichment for a 20 meter spacing between the lines can be estimated as follows (CATINOT, 1965, modified):

|                                                                  | man days/ha |
|------------------------------------------------------------------|-------------|
| <u>1. Year:</u> Selection of area, marking of blocks and lines,  | 2           |
| Clearing of lines, poisoning of trees between lines,             | 11          |
| digging of planting holes                                        | 3           |
| production of planting stock                                     | 5           |
| planting and replanting, incl. transport of planting stock       | 4           |
| weeding                                                          | 2           |
| <u>2. Year:</u> Weed control, climber cutting, further poisoning | 3           |
| <u>3. Year:</u> -dto.-                                           | 3           |
| <u>4. Year:</u> -dto.-                                           | 3           |
| <u>5. Year:</u> -dto.-                                           | 3           |
| <u>6. Year:</u> -dto.-                                           | 3           |
| Total                                                            | 42          |

In addition about 5 lbs of sodium arsenite (about 50 centavos per lb ) and some fertilizer are needed, the value of which will hardly exceed P 15 per hectare. This sums up to roughly P 435 per hectare (based on a daily wage of P 10) including the cost of the seedlings and the maintenance during the first 6 years. About 2/3 of this amount are needed during the first year.

### 16.5 Advantages and disadvantages of line enrichment.

- a) Enrichment planting offers a possibility to bring unproductive forest areas into production again, and provides a chance for natural regeneration in the following rotations.
- b) Enrichment planting provides an opportunity for re-introduction of valuable dipterocarps, which cannot grow in the open in their early stages.
- c) In line enrichment with mahogany there is often less shoot borer attack than in open plantations (40). The possible explanation is that through side and partial overhead shade the formation of long sappy shoots is avoided, which make the tree attractive for the insect. It is also possible, that the forest environment has a positive effect on the life cycles of the natural enemies of the shoot borer.

The main difficulty in enrichment planting generally is to prevent the lines from closing up from the sides and to keep climbers and pioneer vegetation down. Assistance has to be given sometimes several times a year up the age of 6 years.

Considering the success of line enrichment in other tropical countries it would be definitely worthwhile to give it a wide scale trial in the overlogged areas of the Philippine rain forest.

SOME PRACTICAL GUIDELINES FOR FERTILIZER APPLICATION IN  
YOUNG PLANTATIONS

Numerous experiments carried out in temperate and tropical countries have shown, that a considerable increase of height growth and volume production can be obtained through fertilizer application. A significant effect can already be achieved by relatively small quantities applied in the proper way.

17.1 The role of the main plant nutrients and their sources.

a) Nitrogen (N): Because the atmospheric nitrogen cannot be used directly by higher plants, the available N comes mainly from the following sources:

- Mineralization of humus,
- Nitrogen conveyed by rain and thunderstorms,
- Nitrogen-fixing bacteria living in the root nodules of some trees.

Since humus is very unstable under tropical conditions, nitrogen is in short supply in most tropical soils. Nitrogen is an important element in nucleic acids, chlorophyll and proteins, and so determines the production of vegetative matter, including leaves, needles and wood.

b) Phosphorus (P): Though the total phosphorus content of organic and anorganic compounds in the soil is usually relatively high, the quantity of dissolved phosphate-ions

available for the plants, however, generally is quite low. Especially in acid soils most of the phosphorus is rigidly tied up in metal compounds and not available to the plants.

Phosphorus is an important element in the nucleo-proteids and in form of phosphatic acids controls the energy metabolism in the plants. The fundamental biochemical processes of photosynthesis are not possible without the action of phosphoric acids (5). Application of phosphorus has marked influence on diameter growth and lignification of tissues.

c) Potassium (K): Potassium is part of soil minerals, namely feldspars and micas, but it does not become part of organic compounds. Potassium among other functions increases the osmotic pressure in the cells, favors the uptake of water and opposes wilting. With other words, it increases the draught resistance of plants (5).

d) Calcium (Ca): Calcium is found in various combinations in rock and soil minerals. By adding lime we can increase the pH-value of the soil. If the pH-value is too low, the availability of phosphorus would be affected, If it is too high, it would affect the uptake of iron and magnesium.

e) Magnesium (Mg) and Iron (Fe): Magnesium and iron are the central components of chlorophyll and are required in considerable quantities by all green plants. Magnesium is also essential as a regulator for a number of biochemical processes in the plant.

17.2 Type of fertilizer.

Because generally nitrogen and phosphorus are in short supply in most tropical soils, best results were obtained with a well balanced complete fertilizer containing nitrogen, phosphorus and some potassium. In most cases the use of complete fertilizer is to be preferred to the application of

a single nutrient. If only one nutrient is applied, the increased growth would lead also to an increased uptake of those nutrients, which were not supplied by the treatment. This may cause deficiency of these other nutrients which is known as the "dilution effect" (5).

The three or sometimes four numbers printed on fertilizer bags indicate the contents of primary nutrients in the sequence nitrogen - phosphorus and potassium. The fourth number sometimes found indicates the magnesium content. Combinations recommended for forestry purposes are 12-24-12, 14-14-14, 12-12-12 or similar types. Some fertilizers also contain trace elements such as iron, manganese, boron, copper, zinc, molybdenum and others, which are needed only in minute quantities.

### 17.3 Method of application.

Because of the wide spacing commonly used in the plantations an individual application generally is most economical. For the first application it is recommended, that the fertilizer is mixed with the soil at the bottom of the planting hole. This method is to be preferred to a top dressing after planting, because the fertilizer would not be washed away easily by heavy rains and cannot be taken up by shallow rooting weeds.

All subsequent applications, if any, are done in form of a top dressing. The fertilizer is strewn by hand on a radius, which is probably penetrated by the roots ("drip line"). If this radius is chosen too large, the weeds will benefit unnecessarily. For the same reason all weeds in the vicinity of the seedling must be uprooted and used as mulch, mere cutting would not be sufficient. Care must be taken that a high concentration of the fertilizer does not get in direct contact with the root collar. Young teak seems to be particularly sensitive and may be easily killed that way.

A fertilizer dressing combined with soil working around the seedling can give very good results, if done properly. Soil working would help the infiltration of the fertilizer into the soil and increase aeration. The cost of application, however, is higher and there is the possibility of damages to the root system.

All fertilizer application must be carried out during the main growing season. A very favorable time is right at the beginning of the rains, or towards the end of the rainy season, when it is already too late for planting, but the growth of many tree species reaches a maximum. During the peak of the rainy season fertilizer application would probably interfere too much with the ongoing planting work.

### 17.4 Quantity to be applied.

The effect of different quantities of fertilizer on the increment follows the well known input-output curve and may be illustrated by the following experiment:

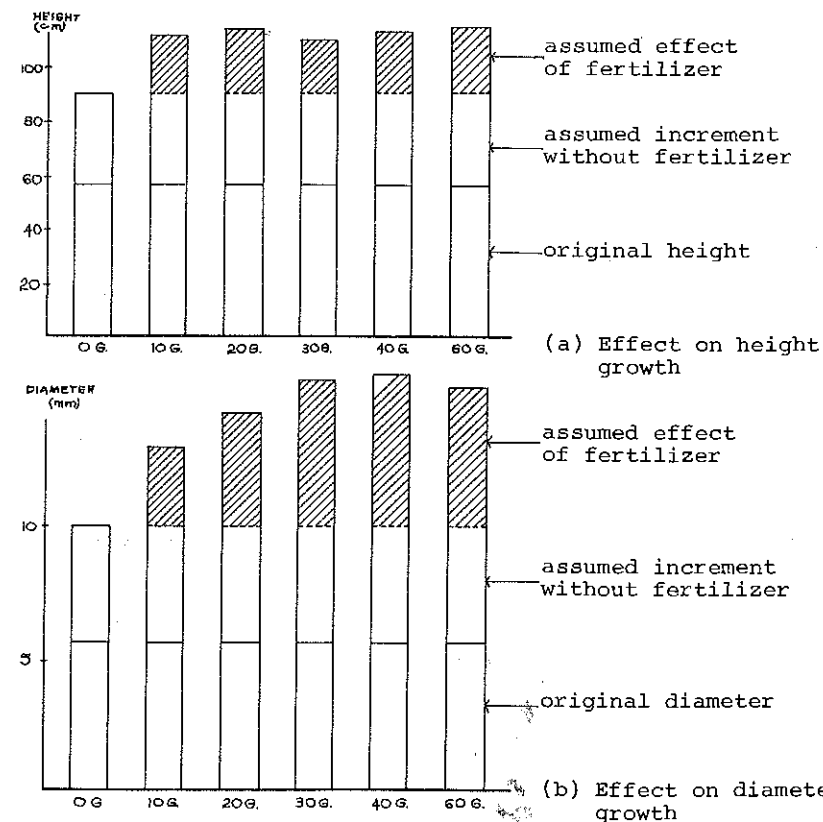

Fig. 24: The effect of different doses of complete fertilizer (12/24/12, plant hole application) on Eucalyptus camaldulensis 11 months after the application. Binga.

Considering the effect on height increment the most significant effect against control ("no fertilizer") was achieved by the 10 gram treatment without any additional increase with higher doses.

For the diameter increment at root collar also the 10 gram application resulted in the most significant increase. 20 gram per seedling, however, showed a greater effect, but the additional increase was only small, for the 30 gram treatment the additional increase was less still.

The quantity applied should result at least in the major portion of "possible" increment. In the above example something between 10 and 20 gram per seedling according to the availability of fertilizer would be the proper dose. The quantity of 20 grams of complete fertilizer per seedling is also in line with recommendations of GUSSONE (1964) for European tree species. For larger seedlings, of course, the optimum quantity would be higher.

If 2500 seedlings per hectare are treated with a 20 gram application, 50 kg (one bag) will be needed per hectare. Based on the prices of 1974 this would cost about 100 Pesos. For application as a surface dressing without soil working about 1 man day is required per hectare, with soil working about 3 man days are needed. To save costs, fertilizer application should be combined with weeding.

#### 17.5 Indications for fertilizer application in plantations.

- On sites, where deficiency symptoms occur (5,37),
- Sites, which are degraded by erosion and where the A-horizon had been washed away entirely,
- Poor sites, indicated by a meager ground vegetation,
- In plantations of fast growing timber species, if after economic analysis fertilizer application would result in higher financial net returns,
- On dry sites application of complete fertilizer would result in a deeper root system and increased draught resistance (effect of K) (27).

- Sites with a strong weed competition. Here the fertilizer must be applied in a way to give advantage to the trees without favoring the surrounding weeds.
- In enrichment planting, where only very few trees per hectare are planted fertilizer application would possibly compensate for light deficiency and enable the seedlings to cope better with the weed species.

### Chapter 18:

#### THE CONTROL OF WEEDS, CLIMBERS AND UNDESIRABLE TREES

#### 18.1 Weed Control.

##### a) General considerations

The more hot and humid the climate, the more weeding operations have to be carried out. In the humid parts of Eastern Mindanao three or four weeding operations during the first year are not uncommon, while in Northern Luzon one or two weedings during the first year would be sufficient. In some places no weeding at all may be required. The number of weeding operations has to be increased, where small and poor planting stock was used for field planting.

A common mistake in weeding is that too much of the vegetation is cleared around the plants. It should be borne in mind, that the grasses and herbs growing near the seedling may also have some beneficial effects on its development. The seedlings might indeed benefit from a light shade, provided they are not suppressed. A light weed competition at an early stage might reduce the formation of strong side branches having a similar effect as close spacing. Besides this the grasses perform a useful function as a soil cover and protection from erosion. Not more vegetation than absolutely necessary should be cut ("ring weeding"). The grass cut is placed as a mulch around the seedling to reduce evaporation and check the new growth of weeds.

For light demanders more clearing is required than for shade tolerant species which do not suffer so much from weed competition. There are species, however, which are very sensitive to any weed competition like teak and most eucalypts. In these cases just cutting the weeds may not be enough, but it may be necessary to eliminate competition in the root zone by uprooting the weeds and doing some cultivation around the seedling.

Care must be taken to avoid sudden exposure of plants, which have already been suppressed by weeds. Here only the overtopping weeds are cut, leaving a side shade. It should be carefully studied, if any "brushing" is necessary at all during the first year, because the grasses in many cases will dry up anyhow. On steep slopes it often happens, that wilting grasses form a complete blanket on top of the seedlings, which must be removed as early as possible.

Any weeding must be done early enough, before the seedlings are suppressed and consequently may suffer severely from sudden exposure. Proper timing of weeding therefore is a decisive factor for the success of the plantation.

#### b) Tools for weeding.

- Bolos, there are many local modifications of this useful tool. For weeding in high cogon and talahib a modification of the

ordinary bolo with an elongated blade and an elongated handle called tabás in Ilocano has proved to be very handy. Since laborers all over the country are used to work with bolos, no new introductions hand tools for weeding are recommended for ordinary field conditions.

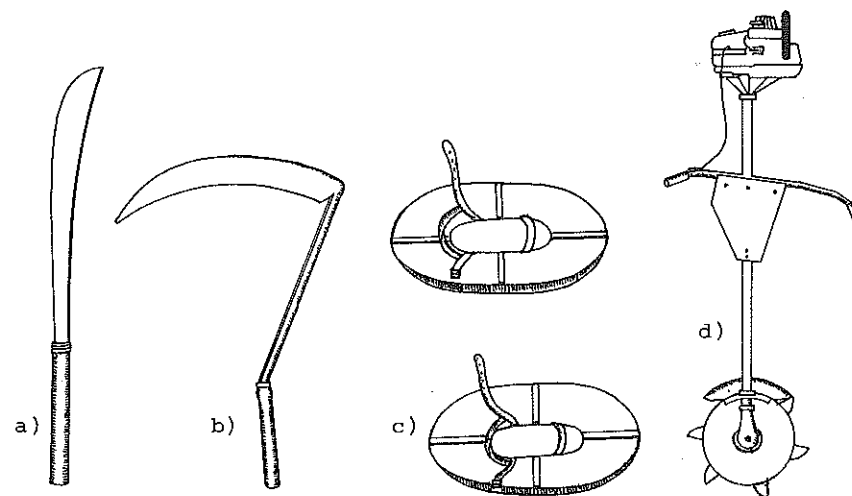

Fig. 25: Weeding tools: a) Tabás, b) sickle, c) weed trampers, d) motor weed cutter with chainsaw motor.

- Motor weed cutters are already found in some reforestation projects. They are driven by a small gasoline motor (chainsaw motor), which operates a circular saw attached to a long handle. Where a chainsaw or a motor plant hole driller is already available, the weeding attachment may be a useful addition. The machine has proved to be quite useful in clearing high cogon, runo, talahib and other sharp edged grasses as well as brushes.
- Weed trampers consist of a pair of frames of oval shape, which are attached to the shoes. The weeds are not cut, but simply pressed down by the weight of the body, which weakens them more than cutting. Their effectiveness should be tried under Philippine conditions. The job must be assigned to a heavy person.

c) Possibilities of chemical weed control in plantations.

Because of the high cost of labor chemical weed control had become very popular with foresters in Europe and the United States. The ideal weed killer required for forest plantations should have the following characteristics:

- effective against Imperata, not necessarily kill it, but retarding its growth,
- harmless for conifers and broadleaved species,
- the use must be cheaper than manual labor,
- the chemical should not be poisonous to man or livestock,
- after the desired result had been obtained, the chemical should desintegrate without any residual effect on the ecosystem.

Up to now there is no herbicide available, which meets all these 5 requirements. In recent years DOWPON with the active ingredient DALAPON had been used with good success in temperate countries to kill grasses with rhizoms. It is taken up by roots and leaves of the grasses and in lower concentrations does not affect most forest trees. From some small scale experiments it appears, that DOWPON is also effective against cogon to some degree, which resists most selective herbicides. But more tests are needed regarding

- the compalatability with different tree species,
- the optimum time for application,
- the quantity required per unit of area,
- the economical analysis of the costs compared to ordinary brushing.

Preliminary tests, however, have shown, that the quantities required to weaken cogon are so high, that also most forest trees are affected (68), and the cost of the chemical will in most cases exceed the cost of manual labor. The prospects of chemical weed control in forest plantations therefore at present are not very favorable. For more information on the different types of chemical weed killers see Part IV.

18.2 Climber cutting.

Climber cutting is a very important tending operation in the moist and humid regions of the Philippines. Severe infestation of climbers can completely cover and deform small trees of sapling size. The control of climbers is often more of a problem than the control of herbaceous weeds and grasses. Because of buried and surviving seeds there are generally more climbers on a forest soil than on a grassland site. Most climbers however, are very light demanding, they disappear as soon as the plantation forms a closed canopy and the conditions for their germination become unfavorable.



Fig. 26: Freeing a tree from climbers with a Y-shaped stick (after HENGST, 1954)



When a tree is completely covered by creepers, one has to use a y-shaped stick and push the vine up. By pulling it down one would easily break the branches or the top of the tree. The vines thus removed from the tree are not cut - they would sprout again- but curled up and deposited at the base of the tree. This weakens their vigor more than cutting (34). With very persistent climber species it is recommended to spray the curled up climber with a 2 % solution of 2,4,5-T, a hormon-based arboricide, to prevent any sprouting.

A climber, which is a very serious pest in Mindanao and Mt. Makiling is Uoko (*Mikania scandens*). Another species which is hard to control is bikal (climbing bamboo), which can form impenetrable thickets suppressing any young tree growth especially in a more seasonal climate. In the humid parts of Mindanao, bulacan (*Merremia peltata*) is often a big problem.

### 18.3 Removal of undesirable trees.

Undesirable tree growth under 6 cm diameter can be easily cut with the axe or the bolo. If larger undesirables have to be removed, this can be done by chainsaw or girdling. Nowadays the use of chemical tree killers had been found more economical and effective, because not all tree species can be killed by girdling alone or would coppice after cutting.

For the preparation of enrichment planting and timber stand improvement two chemicals are widely in use in tropical countries: sodium arsenite and 2,4,5-T. The latter is sold under different trade names (TORMONA or TORDON). Their main characteristics can be compared as follows:

| <u>Sodium arsenite</u>             | <u>2,4,5-T</u>                             |
|------------------------------------|--------------------------------------------|
| anorganic poison,                  | hormon based arboricide                    |
| highly toxic to human and animals, | if pure, low toxicidity to men and animals |

### Sodium arsenite

### 2,4,5-T

|                                                        |                                                                                        |
|--------------------------------------------------------|----------------------------------------------------------------------------------------|
| highly effective for most species,<br>very economical, | acts slower, does not kill all species,<br>more expensive, when diluted in diesel oil, |
| 10 % (by volume) solution in water,                    | 3 % mixture with diesel oil, with water less effective,                                |

If sodium arsenite is to be used, very strict safety measures have to be adopted, because it is a very dangerous poison. For further information on handling sodium arsenite consult FAO, Technical Report No. 3 on Forest Management (1971) or Malayan Forest Record No. 23. Also the use of 2,4,5-T requires all the safety precautions normally used in handling poison. 2,4,5-T normally is not toxic to human beings and animals, but it may contain dioxine as an impurity, which is one of the most dangerous poisons known and toxic in minute quantities.

### Methods of application

- 2,4,5-T applied with a paint brush on the bark around the tree has a lethal effect on most trees provided that the bark is dry and the zone painted is wide enough so that it cannot be bridged by callus formation. More hardy species must be girdled first.
- The poison is applied by pouring a small quantity of it into a continuous frill of overlapping cuts made with a bolo around the tree trunk. The chemical is carried in a dispensing can of 2-3 liters with a long spout and a tight fitting cap and is poured into the frill. This method is very effective against very resistant species like all latex bearing trees (Moraceae, Sapotaceae).
- Application in notches is practical for small trees and large trees with high buttresses or irregular trunks. It is also possible to fill the dry crystals of sodium arsenite directly into the notches.

### The advantages of poison girdling

- cheaper than cutting, the savings can be 20 % or more,
- for sprouting species more effective than cutting,
- the tree poisoned does not cause damage in the regeneration by falling, but is disintegrating slowly, the branches fall one by one,
- there is no sudden opening created, which has silvicultural advantages.

## Chapter 19:

### PRUNING AS A MEASURE OF STAND IMPROVEMENT

Almost all trees have branches. There are very few exceptions only in the tropics like for example palms and younger individuals of malapapaya. Branches are necessary to carry and support the leaf surface of the tree essential for assimilation of carbohydrates and growth, but wood with ingrown branches is considered defective and of inferior quality.

Ingrown living branches are less harmful than dead ones which may cause defects and holes in the lumber. Artificial pruning should therefore be directed more towards the removal of dry branches than of the green ones.

### 19.1 The process of natural pruning.

The extent to which the lower branches die depends largely on the stand density. As soon as a closed canopy is formed, the growth of the branches below the canopy decreases and they finally turn dry. The time in which the canopy closes and the branch is shaded influences to a certain degree the diameter the branch can reach. Natural pruning therefore is best in close even-aged stands without prominent individuals. Heavy branching is sometimes observed on good sites, while the same species on poorer sites shows less branching (61).

The branchiness of the individual tree depends also on genetical factors. We can sometimes observe, that the branching pattern of the mother tree repeats itself in the offspring in a very similar way.

Tropical pines, like Benguet pine often show normal branching at higher altitudes, while at lower elevations the branches grow almost as fast as the terminal shoot resulting in trees without commercial value (example: Benguet pine near Magat, Nueva Vizcaya). Increased shoot borer attack at low elevation may be only part of the explanation.

The great disadvantage of natural pruning is, that the dying branch does not fall for some time. When the branch is dead, it may take years until it is weakened by fungi and insects and finally falls by the action of wind or rain. The activity of fungi is very important for natural pruning. Where the branch wood is protected from decay by a high resin content, natural pruning is delayed. By keeping a conifer plantation dense, we can only influence the thickness of the branches, but not the falling of the dead branches (61).

With most broadleaved species it is different. Here generally dead branches decay very quickly and are dropped. A dense canopy usually is all that is required to obtain clear boles. Artificial pruning in broadleaved stands generally is not carried out as systematically as in conifer plantations. Pruning here is more of a corrective nature as part of the early tending operations (removal of forks, etc.)

## 19.2 Artificial pruning in conifer plantations.

### a) General considerations:

Systematic pruning of entire plantations is a very costly operation. It must be considered, that the expenditure for pruning has to be compounded at current interest rates up to the end of the rotation. Pruning can only be economical, if the increase in value of pruned timber is higher than the compounded cost for pruning.

In the Philippines at present, pruning of conifers may only be indicated in some of the commercial plantations intended for lumber production in long term concessions, where the investor also is in a position to derive the benefits from his investments later.

Another consideration is, that the cylinder of clear wood put on after pruning must be thick enough to be of any value. The part of the stem containing knots should be limited to the innermost core of about 10 cm. The expected coating of clear wood should be at least 10 cm thick. Pruning is therefore economical in the best stands only. It is not advisable for example to prune the heavily branching pines at low elevation, from which never any timber of good quality can be expected.

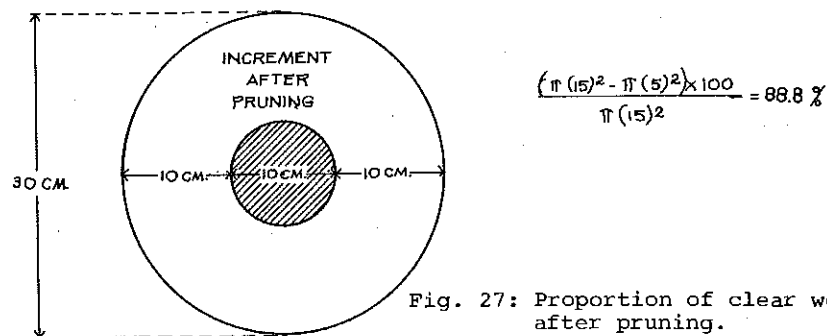

According to fig. 27 a log of 30 cm diameter, which had been pruned as a young tree of 10 cm diameter contains 89 percent of clear wood.

Conifer plantations are usually pruned in three successive stages following the natural development of the crown, until in the third and last stage the tree is pruned up to about 6 or 8 meters. To prune higher than one can reach from the ground, is rarely indicated, because the cost of pruning is progressive at higher levels. Also because of lower increment at higher levels, the output of clear boards can hardly be increased. Generally the most valuable portion of a tree are the lower 6 to 8 meters, which may account already for about 2/3 of the total value.

Since pruning is not yet a standard procedure in the Philippines, as an example the South African pruning instructions for pines may be quoted:

1. Stage: When the stand reaches a top height of 6 meters, all trees except forked and suppressed individuals are pruned up to 2,50 meters.
2. Stage: When the tree reaches a top height of 9 meters, all stems which are left after the first thinning, are pruned to half their height.
3. Stage: When the top height reaches 12 to 15 meters, 375 well formed stems per hectare are selected and pruned up to 6,50 meters.

### b) Tools for pruning.

- A light pruning saw with fine teeth, which can be attached to a handle or bamboo pole of varying length according to the pruning stage. While for the first stage only a short handle is required, for the second stage we already need a pole of about 4,5 m length.

Of all the various models of pruning saws tested at the Training Center the HENGST model gave the best results, it cuts on pull only (Fig. 28).

- Indispensable for pruning are protection glasses to protect the eyes from falling saw dust and small branches. These "glasses" are preferably made of celluloid or a similar material, but not glass.

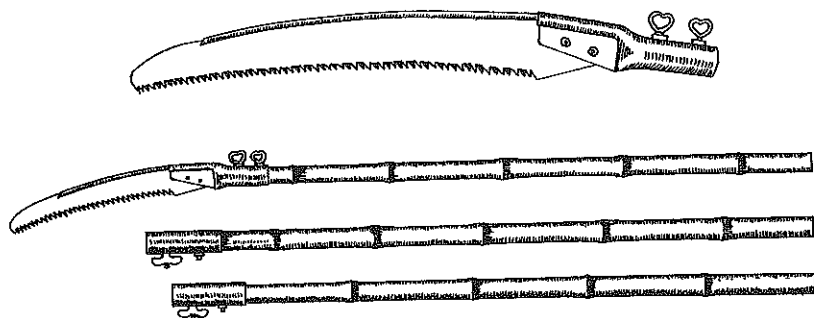

Fig. 28: Pruning saw (HENGST Model) with extension poles.

c) Pruning technique

The branches to be removed are cut directly at the stem with a clean cut. Care must be taken, that the bark below the cut is not injured, which would cause resin pockets in the lumber later. No splinters should remain at the lower side of the cut, because this would delay occlusion and may cause defects in the trunk. Generally only dry branches are removed in pruning of conifers. If occasionally some green branches are cut, this would not have much effect on the tree or the increment, as long as not a major portion of the green crown is removed.

d) Advantages of pruning:

- The financial advantage of pruning depends largely on how much timber free of knots and branches is appreciated,
- Pruning of conifers admits a wider spacing and heavier thinning without a decrease in the quality of the timber. But it is only economical on good sites, where a first class timber crop can be expected, and the increment of clear wood after pruning is sufficient to justify the expenses.
- Some foresters emphasize, that by low pruning the danger of crown fires in conifer plantations is somewhat reduced. The dry branches cut can be piled up where they cannot cause danger in a ground fire as was demonstrated in a small scale at the Bobok Concession.

19.3 Correction of growth forms in hardwood plantations.

The correction of growth forms is a very important stand improvement operation in the early stages of a hardwood plantation. The cost usually is very small compared to the increase in timber quality. Since only a portion of the trees receives treatment preferably at an early stage, the expenses are only a fraction of the costs as compared to pruning conifer plantations.

- a) Removal of forks: This particularly important for species, which have a natural tendency to fork like narra (*Pterocarpus indicus*). But also in all the other species forks must be treated as early as possible. After a greater diameter had been reached, no corrections can be made any more for the danger of fungus infections. Besides true forks also branches, which form an abnormally small angle with the trunk have to be removed, because they almost inevitable will cause defects in the timber, after the branch has died (Fig. 29).

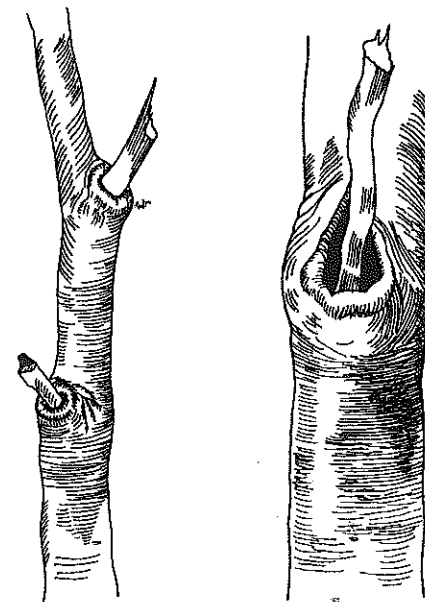

Fig. 29: The effect of forks and branches which form a small angle with the trunk: water enters the pockets after the branches have decayed and causes defects (drawn after HENGST, 1954)

The fork is cut directly at the stem, as long as its diameter is below about 4 cm. For larger forks the same procedure as for large branches is recommended (see below). Forks of over about 8 cm generally cannot be removed from forest trees anymore.

In young plantations cutting of forks is only a matter of a few hours. The treatment should be repeated at least 2 times. The first treatment is recommended before the plantation reaches 2 meters in height, the second when the top height reaches about 6 meters. In the first treatment pruning shears are the main tools (Fig. 30) for the second stage a pruning saw attached to a bamboo pole (Fig. 28).

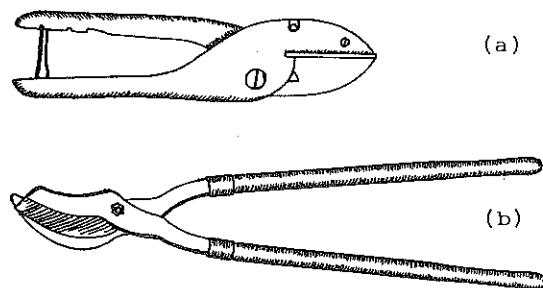

Fig. 30: Pruning shears: (a) Model "LOEWE" for thin branches (b) Model "WALDTEUFEL" for branches up to 6 cm diameter.

The commercial value of a tree forking right above the ground is much less as compared to a tree where all the increment had been concentrated on one trunk only. As stated before, the major portion of the value of a plantation normally is constituted in the lower 6 to 8 meters. If we can eliminate forking that portion, we would increase the timber value of the plantation considerably.

b) Removal of abnormally strong branches.

Trimming a tree with abnormally strong branches back to normal shape is carried out in three cuts, as illustrated in Fig. 31.

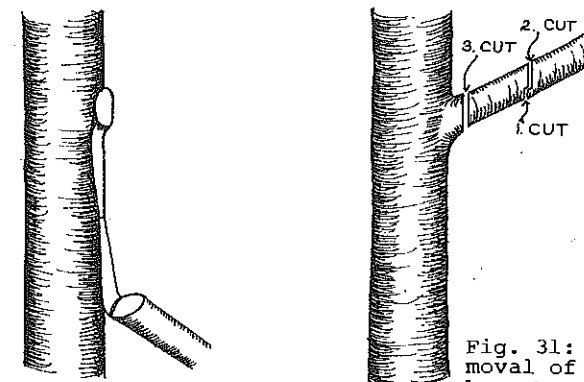

Fig. 31: Proper removal of strong branches (8).

If we attempt to cut the branch directly with one cut, there would be always the danger, that the branch goes off with a piece of bark inflicting serious injuries to the tree. It is very important, that the branch is cut directly at the stem. Leaving a stump, which grows into the tree, would cause very serious defects in the timber (Fig. 32).

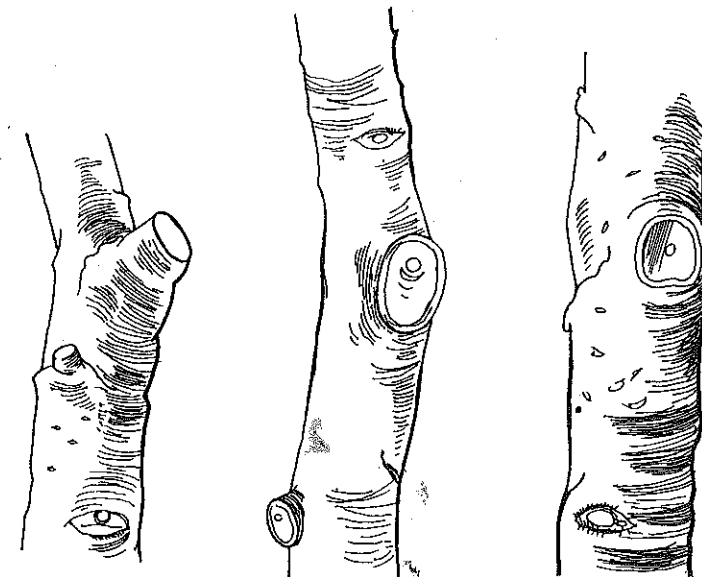

Fig. 32: Cutting of branches: a) too much of the branch is left b) improper cutting angle, c) cutting through the branch swelling causes a very large wound, only the outer margin of the swelling should be slightly touched by the cut, d) proper cut (drawn after HENGST, 1954)

For European timber species it is known through experiments up to which maximum diameter a green branch can be cut safely without risking fungus infection. Similar experiments as a basis for tending instructions are recommended for the Philippines. With a species like teak with a wood very resistant to rot, a larger diameter can be pruned than with a softer and easier rotting species. The scars of teak branches of 4 cm diameter pruned in Binga were completely occluded by callus formation after 12 weeks. To avoid, that the cut is exposed for a long time and risking fungus infection, the work should be carried out during the main growing season. The application of tree wax is usually not done in forest plantations. Only for valuable ornamental trees a mixture of bitumen and creosote is recommended for protecting large cuts.

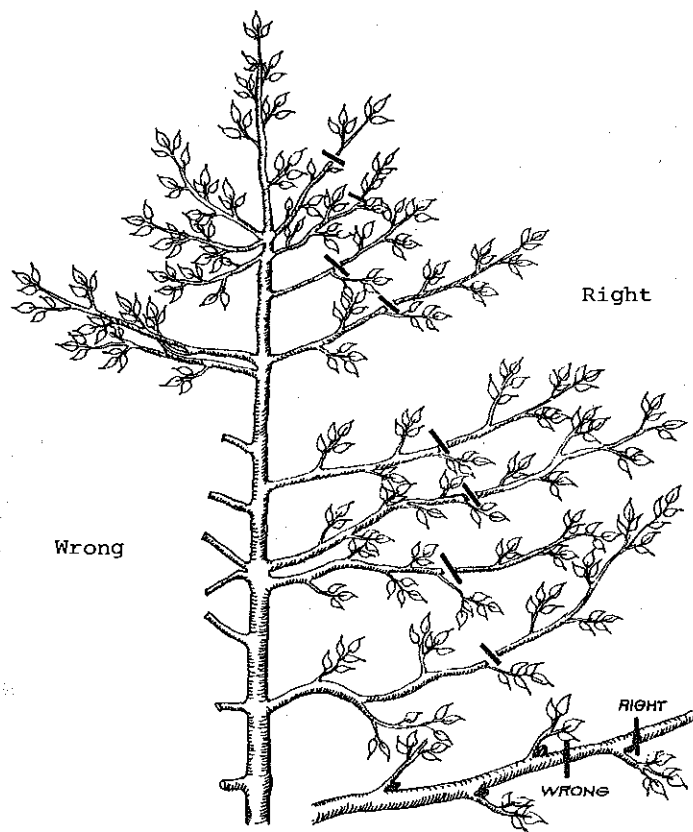

Fig. 33: Proper trimming of abnormally strong branches. (drawn after HENGST, 1954)

When branches are too thick for pruning already or the species is very delicate, the branch is not cut directly at the stem, but about 3 feet away. Cutting only a portion of the branch has the effect of reducing a strong branch to secondary importance. The remaining portion of the branch must still be long enough to fall by its own weight, once the branch is dead and decaying. Leaving stumps of about 30 cm as can be often seen is a serious mistake and will cause defects in the timber. The cut has to be conducted right behind a bud pointing downward or sideward. Cuts made behind buds pointing upward would stimulate forking (HENGST, 1954).

- c) Treatment of poorly shaped trees: A forester is quite often confronted with teak plantations of poor shape due to fire, grazing and illegal fuelwood cutting resulting often in crooked trees, multiple leaders, and heavy branching. The best remedy is to cut back those trees directly above the ground. The reserves of the root stock will produce within a year a straight branchless shoot several meters high. A few weeks after cutting one has to remove all but the strongest shoot from every root stock. A similar treatment is also given to leaning trees.
- d) Treatment of wolf trees. Wolf trees are individuals, which show abnormally fast growth combined with excessive branching. In very young plantations these can be directly removed without harm. At a later stage it is preferable from the silvicultural point of view, that they are only heavily pruned and their top is cut. If we remove them completely at a late stage, we would create a large opening, into which the neighbors would extend strong branches. A large opening at a late stage may also be the starting point for wind fall.

THE BASIC PRINCIPLES OF THINNING PLANTATIONS

When we start a pine plantation we plant commonly at a spacing of 2 by 2 meters, which amounts to 2500 seedlings per hectare. In the final stand after 60 years or so the number of trees reaching maturity is only 250 to 500 per hectare. All the rest of the initial number, about 80 to 90 percent, will have died through natural causes or had been eliminated by successive thinnings. The aim of thinning is to correct the course of nature in the elimination of individuals and to retain only the best stems up to maturity.

20.1 Thinning of young stands.

All the undesirable individuals are removed at an early stage of the plantation, which at first may be part of the tending operations, later, when the diameter has reached salable size, is part of thinning.

This negative selection is also called r e f i n i n g, which means to remove impurities from a mixture (18). Refining is the contrast to l i b e r a t i o n of the best stems at a later stage. The individuals to be removed in the refining operation are:

- Individuals of undesirable species,
- Trees, which show abnormal tendency to fork,
- Wolf trees,
- Trees, which are defective otherwise,

Thinning must start as soon as crown competition sets in to provide enough growing space for the remaining crop. If thinning is delayed, the plantation would become stagnant. The struggle for survival can be very prolonged with shade tolerant species. In dense stands of light demanders, the weaker individuals succumb quickly and only the most vigorous survive.

Mechanical thinning: In young overcrowded plantations and natural regeneration, very often a so-called mechanical thinning is carried out as long as the individuals are not yet well differentiated in respect of height growth and diameter (61). The objective is merely a regulation of spacing; where extensive plantations are to be treated, and where only untrained labor is available.

According to circumstances, in mechanical thinning, for example, every second or third line or tree within a line is removed, or in natural regeneration a minimum distance between trees is prescribed. Deviation from the prescribed spacing is only tolerated in exceptional cases where an obviously good individual would have to be removed in favor of an inferior one.

20.2 Thinning of older plantations.

For a given species, each site has a certain potential increment. The objective of thinning is to concentrate this potential increment on the best trees only by removing the competition of inferior neighbors. The trees of the lower stratum, which do not compete much in getting a share of the potential increment, are generally spared in thinning as a useful ground cover. In most cases their timber value does not cover the cost of removal.

While in young stands we have selected the inferior individuals to be cut, we now change our point of view and make a positive selection instead. We select the best trees and cut those, which compete with them in the crown region. This is also known as "liberation cutting" (18). So, only a tree will be removed, if a better substitute will really profit

from the additional root and crown space.

When marking the trees for felling we always have to look at the situation in the canopy, not at the spacing on the ground. All the increment of a tree depends on a well developed crown, because this is the place, where the carbohydrates, the elements of wood, are produced. To develop a healthy crown capable of high increment, it is important, that thinnings are carried out early enough. If thinnings have been delayed, many species would not respond to additional growing space at a later age. One important principle of thinning is therefore "early - moderate - often". Species which are able to make use easily of additional growing space by extending their branches into the newly created openings, those can be thinned more heavily, e.g. *Gmelina arborea* and *Albizia falcata* on good sites.

The edges of the plantation have to be kept as dense as possible to maintain a favorable "forest" climate in the interior of the stand.

A situation often faced when marking trees for thinning is that there may be two trees of equally superior quality growing closely together on a relatively small area. Observations under natural conditions have shown, that the increment of both of them may not be reduced, as long as there are possibilities for lateral expansion. In this exceptional case the two trees can be treated as a "thinning unit" without losing increment.

### 20.3 Numerical guides for thinning.

In many countries exact instructions exist - sometimes as part of the yield tables - how much to remove and how much to retain in thinning operations at different ages. These instructions are sometimes based on the basal area, sometimes only on the number of trees per hectare, or even the average distance between the trees.

a) Where growth is very uniform thinning instructions may be based only on the number of trees per hectare to be

retained at the respective ages, perhaps differentiated for different site classes. But this would imply, that the plantation area is known and the trees are counted, or the number of trees per hectare has to be transformed into average distance between the remaining trees. As an example the thinning schedule for slower and fast growing pines in South Africa may be quoted:

#### Thinning schedule for slower growing pines in South Africa

| <u>Site Class I</u> |               | <u>Site Class II</u> |               | <u>Site Class III</u> |               |
|---------------------|---------------|----------------------|---------------|-----------------------|---------------|
| Age                 | Stems/ha      | Age                  | Stems/ha      | Age                   | Stems/ha      |
| 0                   | 1265          | 0                    | 1265          | 0                     | 1265          |
| 9                   | 700           | 8                    | 700           | 7                     | 700           |
| 14                  | 500           | 13                   | 500           | 13                    | 350           |
| 20                  | 275           | 18                   | 275           | 20                    | 200           |
| 25                  | 225           | 23                   | 225           | 60                    | Final felling |
| 40                  | Final felling | 50                   | Final felling |                       |               |

#### Thinning schedule for fast growing pines in South Africa

| <u>Site Class I</u> |               | <u>Site Class II</u> |               | <u>Site Class III</u> |               |
|---------------------|---------------|----------------------|---------------|-----------------------|---------------|
| Age                 | Stems/ha      | Age                  | Stems/ha      | Age                   | Stems/ha      |
| 0                   | 1265          | 0                    | 1265          | 0                     | 1265          |
| 8                   | 750           | 6                    | 750           | 6                     | 750           |
| 14                  | 500           | 12                   | 500           | 14                    | 375           |
| 20                  | 325           | 18                   | 325           | 20                    | 250           |
| 25                  | 250           | 23                   | 250           | 50                    | Final felling |
| 30                  | Final felling | 40                   | Final felling |                       |               |

Table 6: Thinning schedule for pines in South Africa based on the number of trees per hectare (SCOTT, 1960).

- b) Another numerical guide for thinning used in Germany and other countries is the basal area, which is a good indicator of the stand density. The basal area has to be kept well below the possible maximum, otherwise the diameter increment will be reduced or becomes stagnant. Only by cutting some trees the selected remainders will put on new increment, until the maximum basal area is built up again.
- c) In some countries the relation between top height (the height of the 100 highest trees) to average distance is used as a guide for thinning. This is based on the assumption, that



higher trees require a wider spacing. Thinning instructions for *Pinus merkusii* in Indonesia according to COOLING (1968) are based on an average spacing of 22 % of the top height.

20.4 The relation between thinning intensity, volume production and financial return.

A logical indicator of the thinning intensity is the basal area. If we assume the basal area without thinning as 100 percent, then

|                         |               |
|-------------------------|---------------|
| light thinning would be | 90-95 percent |
| medium thinning         | 70-90 percent |
| heavy thinning          | 50-70 percent |

The question is now, which of the four possibilities gives us the maximum volume and which the maximum financial return or both.

For illustration the results of a thinning experiment with *Pinus radiata*, Penola Forest Reserve, South Australia are quoted here (43):

| Trees per ha | age 17 |           | age 24 | age 30 | age 36 | age 38 |
|--------------|--------|-----------|--------|--------|--------|--------|
|              | before | after th. |        |        |        |        |
| No thinning  | 2161   | 2161      | 2043   | 2006   | 1917   | 1892   |
| light thin.  | 2211   | 1247      | 765    | 620    | 496    | 496    |
| medium thin. | 2100   | 988       | 610    | 511    | 366    | 366    |
| heavy thin.  | 2124   | 773       | 553    | 425    | 245    | 245    |

Table 7: Reduction of the number of stems per hectare by successive thinnings in a *Pinus radiata* plantation planted 1923 at an initial spacing of 2.10 by 2.10 m, site class IV, first thinning at the age of 17 years (after LEWIS, 1962).

While under natural conditions in this case without thinning still 88% of the trees remain at the age of 38 years, under heavy thinning, however, their number is reduced to a mere 12 % (but of considerably larger diameter).

| Thinning intensity | Total volume (cbm per ha) inc. thinnings | Total volume (cbm per ha) of thinnings | Cumulative value up to 38 yrs. (Australian Pounds) | Net present value of the age of 38 years |
|--------------------|------------------------------------------|----------------------------------------|----------------------------------------------------|------------------------------------------|
| 1                  | 2                                        | 3                                      | 4                                                  | 5                                        |
| No thinning        | 790                                      | -                                      | L. 1571                                            | L.148                                    |
| light thin.        | 911                                      | 311                                    | L. 1909                                            | L.808                                    |
| medium thin.       | 899                                      | 344                                    | L. 2016                                            | L.946                                    |
| heavy thin.        | 873                                      | 461                                    | L. 1941                                            | L.988                                    |

Table 8: Volume and value production at a rotation age of 38 years under different thinning intensities. The net present value (column 5) considers cost of establishment, maintenance and logging at an interest rate of 5% (Faustmann formula) and is based on current royalty rates (after LEWIS, 1962).

Total volume (column 2, table 8): The volume produced by the unthinned stand is considerably less than the thinned plots. Because of the high density of the unthinned plots many stems can reach only diameters below 10 cm which is too low for general industrial use and therefore is not considered in the volume computations. The differences in total volume production between the light, medium and heavily thinned plots are not significant. The results of this experiments show, that thinning within reasonable limits does not have a significant effect on volume production, which also is in line with findings in Europe (69).

Total volume of thinnings (column 3, table 8): The figures show that in the lightly thinned plot about 1/3 of the volume, and in the heavily thinned plot about 1/2 of the volume is obtained from thinnings.

Cumulative value (column 4, table 8): The cumulative values of the thinned plots differ significantly from the value of the unthinned plot. This has two reasons: first, the average diameter of the timber from the thinned plots is higher and therefore commands a higher price. Second, by thinning we remove the inferior trees and concentrate the potential increment of the site on the best individuals, which raises the average quality of the stand and the value.

Net present value (column 5, table 8): The net present value considers compound interests from the time on when the yields are actually obtained, but deducts all costs (establishment, maintenance, logging) also at compound interest. The figures clearly show the advantage of heavy thinning, because high yields are obtained already at an early date.

Besides resulting in higher value production, thinning also increases the resistance of the stand against windfall. But cutting of trees has to start at an early age of the plantation and has to be carried out gradually. A sudden opening at a later age could have the contrary effect and promote wind damages. Also the resistance against pests and diseases is increased in a properly thinned plantation, because there are not so many dead and dying trees.

Chapter 21:

## FOREST FIRE CONTROL

The effective control of forest fires is one of the greatest problems of the reforestation program in the Philippines. Especially areas with a seasonal climate are hard hit by forest fires almost every year. According to the annual report of the former Reforestation Administration for the fiscal year 1969/70 a total area of 3300 hectares was burnt, 1970/71 rd. 1400 hectares were reported burnt (58).

### 21.1 Fire causes

- Burning of pastures: Cattle owners set fires in cogonal pastures annually, to burn the old cogon and induce new growth, which is palatable for their cattle, while the old and dry cogon cannot be eaten. Burning of pasture land is practiced throughout the tropics and may be one of the most frequent fire causes in forest areas.
- Incendarism: It had been reported frequently, that forest fires were intentionally caused out of personal grudge against the forestry personnel. Laborers, who were laid off, were said to have started sometimes forest fires out of revenge.
- Escaped kaingin fires may be another very frequent cause of fire. Burning of kaingins is generally done at the peak of dry season, when the danger of forest fires is highest. Especially on slopes the kaingin fires often get out of control easily and destroy neighboring forest land.

- Carelessness: Many forest fires are started out of carelessness from abandoned camp fires, cigarettes, burning of trash and other causes. Very often playing children are involved.
- Lightning: A fire caused by lightning is theoretically possible, but rare in practice. When there is lightning generally it will be followed by rain, which would extinguish the sparks.

### 21.2 The development and behavior of a forest fire

If an inflammable material is heated and oxygen is added, a fire will start. The ignition temperatures for some fuels are as follows (32):

|                       |       |
|-----------------------|-------|
| - Dry paper           | 132°C |
| - Pine shavings       | 227°C |
| - Average forest fuel | 293°C |
| - Heavy logs          | 578°C |

By radiation from the flames the neighborhood is heated and the fire will progress. Where grasses or litter are already dry, only little heat is necessary to evaporate the remaining moisture and allow the fire to spread. When the flames are able to reach the bark of the trees or the needles of the lower branches, the ground fire may develop into a crown fire. In young pine stands the crown fire is the usual case. In middle aged stands there is no crown fire without a steadily progressing ground fire to prepare the crown region of the uplift of the fire. A crown fire causes a strong upward movement of air (convection column), which sometimes takes sparks high up and deposits them far ahead of the fire front. New spot fires may be started that way. A black smoke, whose color is due to charcoal particles, usually indicates a great number of sparks (44).

From the place of origin the fire spreads in all directions, but only the edge of the area is burning, beyond this edge only some stumps and thick branches are still on fire. The depth of the fire front may be only one or two feet.

If the ground is level and the weather is calm, the fire will spread more or less evenly in all directions. If there is wind, the fire will progress fast in wind direction, against the wind however, the progress will be slow. The result generally is a fire area of elongated shape with a curved front line.

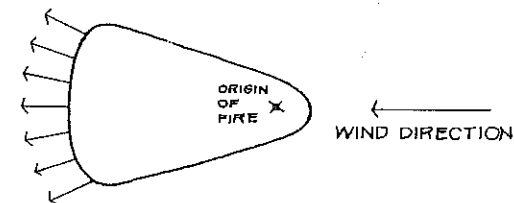

Fig. 34: Spreading of a forest fire

The front of a forest fire progresses with a speed of 200 to 1200 meters per hour, large fires burning uphill may reach 2000 meters per hour. On level ground the normal speed is below 500 meters (44). Uphill the progress is very fast, downhill quite slow. A slight down slope can reduce the speed already considerably.

The intensity of a forest fire depends on the type of vegetation, and atmospheric conditions.

- Vegetation: Most easily a fire can spread in a plantation with a massive cover of dried up grasses. After the plantation has formed a close canopy and shaded out the grasses, the fire hazard is reduced. For dangerous localities it is desirable therefore to choose a species, which is able to shade out grasses very early.

The more fuel is available in a place, the higher will be the fire intensity, especially, if the fuel is concentrated and highly inflammable. This is often the case in areas which had been successfully protected from fire for two or three years and have built up a thick cover of dry grasses.

A middle aged conifer plantation with many dry branches down to the ground can still be destroyed by fire, even if the grass cover is very thin. Though most conifers are very susceptible to fire

in their younger stages, they may develop a thick bark when older and become quite fire resistant. According to LIZARDO and CALEDA (1959) pines over 13 cm dbh have a fair chance to survive a medium grass fire.

| <u>Diameter</u><br><u>cm. d.b.h.</u> | <u>Survival</u><br><u>Percent</u> |
|--------------------------------------|-----------------------------------|
| below 4                              | 0                                 |
| 4                                    | 0                                 |
| 5                                    | 12                                |
| 6                                    | 21                                |
| 7                                    | 16                                |
| 8                                    | 22                                |
| 9                                    | 12                                |
| 10                                   | 16                                |
| 11                                   | 16                                |
| 12                                   | 26                                |
| 13                                   | 61                                |
| 14                                   | 85                                |
| 15                                   | 89                                |
| 16                                   | 100                               |

Table 9: Survival of Benguet pine in a medium grass fire (45)

Plantations of deciduous broadleaved species with a thick ground cover of dry leaves are more liable to be destroyed by fire than a plantation of evergreen species. A dense, slightly moist, plantation of broadleaved species with a scarce ground vegetation will hardly ever catch fire.

- b) Atmospheric conditions (temperature, rel. humidity, wind):  
The effects of temperature and humidity on the intensity of a forest fire are closely interrelated. With rising temperature in the morning the relative humidity of the air will drop, reaching a minimum in the early afternoon. At this time also the fuel is dried up and the fire danger is highest. During the night, however, the relative humidity increases with falling temperature and the fuel absorbs moisture, which reduces the fire intensity. Fire danger is high on southern and southwestern slopes, especially when the relative humidity drops below 50 percent.

The effect of wind on the fire intensity is that it adds more oxygen. A strong fire always creates its own air movement by

sucking in fresh air, consuming its oxygen and releasing the heated air in a convection column. On a slope usually an uphill wind will develop.

After having outlined fire causes, the development and behavior of a forest fire, we have to deal with the actual fire control. Four phases can be distinguished (32):

- Preventive measures,
- Detection of fires,
- Organization of fire fighting,
- Suppression of forest fires.

21.3 Preventive measures. This is the most important phase in fire control. It includes

- a) Education: Fires caused by carelessness can be prevented by starting a well planned education campaign as undertaken by the U.P. Forestry Extension Office through the mass media radio, television, press, and lecturing on the benefits of forest conservation and the dangers of forest destruction. Involvement of teachers and school children is very important. Signs and posters with slogans have to be put up. Special film shows combined with lectures must be arranged for the communities (25).
- b) Involvement of the community: A possibility would be to set up a non-fire bonus system. Where no fire occurs during the year, the barrio or the barangay will be given a certain amount for community projects. For the government forests this bonus system still needs the legal approval. Private companies have adopted it already with success. Some government foresters practice an indirect bonus system by giving employment for a certain number of days to people from barrios where there was no fire.
- c) Burning permits: Kaingineros and pasture owners have to be requested to obtain a burning permit from the fire guard or district office. This permit is valid only for the day and

area indicated, so that the necessary precautions can be taken to avoid that the fire will spread into neighboring plantations.

- d) Strict law enforcement and the heavy punishment of the offenders can only be the last resort. Since it is easy to put fire on a plantation, but very hard to catch the offenders, strict enforcement of forest laws may not be very effective.
- e) Separation of forestry and grazing: See chapter 25 Part II and chapter 5.5 Part V.
- f) Construction and maintenance of a forest road system.

Besides for effective management, an adequate road system is essential for transporting the fire fighters to any part of the area within reasonable time, after the outbreak of a fire was reported. A good road system also opens up the possibility to use a forest fire truck, a vehicle especially equipped to deal with forest fires.

At present many places in the critical Binga-Ambuklao Watershed, for example, can only be reached after many hours of exhausting hikes.

- g) Measures to reduce the fire hazard in plantations.

There are several species, which are able to sprout after a fire like teak, guava, some eucalypts and some legumes which should be given preference on dangerous sites. Pines are very sensitive to fire in their young stages, but become quite fire resistant once they are older and have developed a thick bark.

Large plantations of inflammable pines must be broken up by fire breaks consisting of less inflammable species with a dense foliage. As minimum width of these fire breaks 10 to 20 meters is suggested. The distance in between depends on judgement. It should be closer up and down the slope than along the contour. To shade out grasses quickly fire breaks are planted more closely than ordinary plantations.

Once established these fire breaks need no maintenance in contrast to fire lines. In the Pinus merkusii plantations of Sumatra extensive artificial fire breaks of Macadamia hildebrandii (Proteaceae), which form a very dense canopy, are effectively employed. If there are natural fire breaks like creeks with a moist type of evergreen vegetation, these must be carefully preserved. It is also advisable to establish fire breaks of broadleaved species, along roads passing through the plantation areas.

Another measure to reduce fire damage are fire lines. These fire lines are strips about 10 meters wide on which all inflammable vegetation is to be cleared at the beginning of the dry season. The effectiveness of fire lines is disputed among foresters. They may be able to stop a ground fire, but they are easily crossed by sparks. Fire lines are laid out in strategic positions, where the fire would burn with less intensity like along roads, ridges, creeks, etc.

#### 21.4 Fire detection

It is not reliable to assume, that the people living in a certain area will report the outbreak of a forest fire to the fire guard or the district office. Therefore it is essential during the dry season to appoint fire guards and to have fire patrols. These fire guards have to be supervised closely to be efficient in their duties.

Where large areas have to be guarded, it is advisable to construct watch towers at prominent places, from where wide areas can be overlooked. Because of frequent typhoons these fire look-outs must be quite solid. The uppermost platform must have windows on all sides. At the center of the room the so-called fire finder is erected, which consists of a dial with a 360° subdivision and a sighting device. If the fire guard notices smoke at a certain bearing, he will contact the district office or any place responsible by phone or radio. The message must contain the designation of the watch tower, the bearing of the fire, the estimated distance from the tower

and the probable intensity of the fire. When two fire guards report the same fire, the exact location of the fire can be determined on a map.

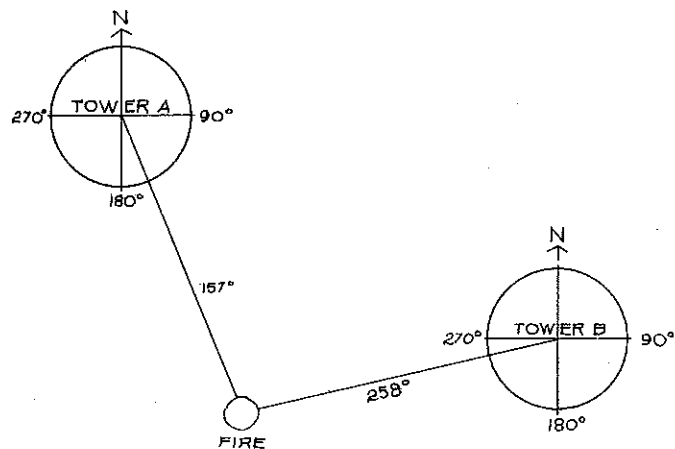

Fig. 35: Location of a forest fire on a map, after the fire had been reported from two different lookouts.

#### 21.5 Organization of fire control.

Every district office and project office should have a plan what to do, when a fire is reported. Instructions about the technical details of fire fighting are to be given to the staff every year at the beginning of the dry season. Arrangements should be made with the army to help in extensive forest fires. The alarm plan must be hung visible in the office and include also the telephone numbers of the nearest police station, nearest forest office, army headquarters and hospital.

Vital equipment needed for fire fighting must be ready at any time. This includes:

- a vehicle with sufficient gasoline,
- fire swatters, sharp bolos, spades, grub hoes,
- water bags for drinking water.

- a first aid kit equipped for burns, cuts, smoke poisoning, snake bites,
- helmets

Red arrows must be prepared to show the way to the meeting place. A person with organizing talent is to be appointed as the fire boss.

#### 21.6 Fire Suppression

There are several possibilities to attack a forest fire. It is up to the fire boss to decide on the proper method.

##### a) Direct attack

A direct attack from the front is only possible in smaller forest fires progressing with low speed. If they are larger and progressing fast, a flank attack may be more advisable. For very intensive fires burning uphill an indirect attack would be the safest.

In direct attack the flames are extinguished with the help of long handled fire swatters or, if not available, with branches. Intensive fires are first cooled and weakened by throwing mineral soil into the flames. The first aim in attacking the fire front is to create a gap. The second step is to widen this gap on both sides. Without actual experience one does not realize, how the flames will collapse on both sides of a gap only one meter wide (44). Attacking the front at first sight often appears to be impossible because of strong heat, smoke and sparks. But when the wind changes the direction or the fire passes an area with less fuel, there may be chances for a frontal attack (44).

The use of fire swatters or branches in a frontal attack on a ground fire is more effective, when several persons beat the fire simultaneously in a rhythm. When the heat radiation of the fire does not permit to get close enough, soil will be thrown to suffocate the flames. Most effective is when several persons throw their load simultaneously to the same spot. The bare places, from where the soil was taken can serve

as a fire line (44).

Where backsprayers and water are available the frontal attack is easier. The water spray is directed against the base of the fire on the ground. The steam will cut off the oxygen supply. After the fire has been weakened by spraying, the rest is done by throwing soil or beating with branches. Water is used only where it is most urgently needed.

#### b) Defense measures or indirect attack

Defense measures include the construction of fire lines well before the advance of the fire front. Already existing fire lines have to be widened, if they are suitable, or new ones must be laid out at strategic points. New defense lines are preferably constructed on ridges, roads, trails, creeks, or other natural fire breaks. In flat country bulldozers can be used for rapid construction of defense lines.

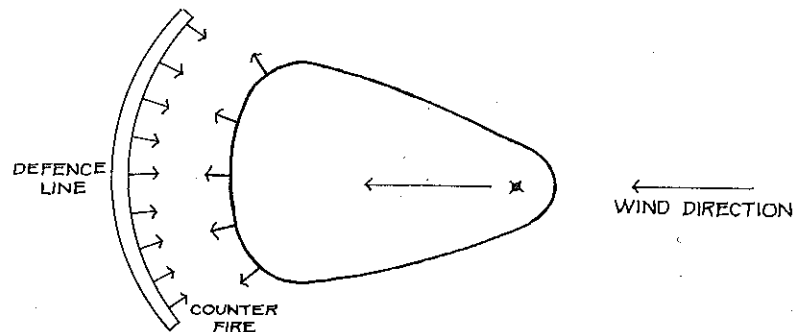

Fig. 36: Defence line with counter fire

In the beginning it may be sufficient to have a width of about 50 cm, but the line must be strengthened later when there is time. The more intensive the fire, the faster its progress, the wider the defence line has to be. On steep slopes a wide fire line is required.

When organizing the fire fighters for defense line construction, there are two possibilities:

- Each man is responsible for a complete section,

- Each man gets only a 3 m section to complete, then the whole team shifts to another section.

All vegetation on the fire line is cut and placed outside about five meters away. There must be constant patrolling for weak points and eventual spot fires developing from sparks beyond the line.

Sometimes forest fires had been successfully controlled with the help of a back fire, which can only be started from a fire line before the fire front. It is allowed to burn slowly in the direction of the main fire. If the counterfire has been successful, it soon will get into the suction of the main fire and approach the fire front with increasing velocity. When both fires meet, they die off due to lack of fuel.

In practice a counterfire often has increased the damage, because it got out of control. All the people working on the fire front have to be notified, before a counterfire is started, that they will not be trapped between two fires. Very often backfires have jumped the fire lines or have escaped control at the flanks. While theoretically a counterfire seems to be the right thing to do, in practice it proved to be difficult.

#### c) Mopping up a forest fire

After the team is in control of the fire, all the burning remains have to be extinguished very thoroughly until no embers are left on the burnt over area. The mop up includes:

- separation of burning fuels,
- cover burning fuel with soil,
- strengthen fire lines,
- stay with the fire until all sparks are out.

After the mop up has been completed, a guard should stay behind to watch for any new outbreak. The man left behind should be equipped with all necessary tools, food and water. Very often there is a new outbreak of the fire the following day about noon, when a fresh breeze is coming up. It has often

happened, that the second fire did more damage than the first. Therefore adequate guarding of the burnt over area for one or two days is very important.

#### 21.7 Equipment for fire fighting

- a) Fire swatters with flexible steel blades mounted on long handles (200 cm) are used to extinguish light grass or ground fires. They are more effective than pine branches, but a little heavy and difficult to use on steep slopes.

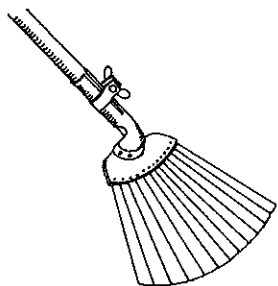

Fig. 37: Fire swatter

- b) Bolo: A sharp bolo should be carried by every man proceeding to the fire site. It is used to chop down branches to be employed as fire swatters, to clear fire lines and trails.
- c) Shovels and hoes are only to be taken to the fire site where conditions permit their use.
- d) Backpack pump can: The tank contains 20 liters of water. The water is used only where it is most urgently needed: in frontal attack to create a gap, to break up fire concentrations, in mopping up remaining embers.
- e) Containers for drinking water are equally important than the rest of the tools. Minimum 2 liters per person, better more.
- f) First aid kit equipped to deal with cuts, burns, snake bites, etc. The first aid kit is the responsibility of the team leader. All medicine must be fresh and clean, and be replaced from time to time.

#### Chapter 22:

#### PREVENTION OF FUNGUS DISEASES IN FOREST PLANTATIONS

In contrast to temperate regions until now there were relatively few reports from tropical countries, that a fungus disease had become a serious calamity. The reason may be the heterogeneous composition of tropical forests, which had been a safeguard so far. But the trend now in tropical countries is also towards large even-aged stands for mass production of lumber and pulpwood. These extensive even-aged plantations often consisting of exotic species replacing the native heterogeneous tropical forest may cause a breakdown of the environmental resistance, and increased incidents of fungus epidemics can be expected to occur in future.

Fungus attack on forest trees can have many manifestations:

- Damping-off of young unignified seedlings is found in moist, overcrowded seed beds or seed boxes (for more information see Part IV, NURSERY TECHNIQUES).
- Heart rot is caused by fungus attack of the central tissue of a stem, which is very common in overmature trees. Entry occurs through dead roots, dead branches or major stem injuries (Fomes, Ganoderma).
- Rusts are caused by fungi of the order URODINALES. For their complete development many species need alternate hosts, e.g. the bamboo rust found on *Dendrocalamus strictus* needs the presence of *Randia* spp. (Rubiaceae) as an alternate host.
- Root rot is caused by fungus infection of the root system and is responsible for the death of many trees



without a visible sign from outside (*Armillaria mellea*, *Ganoderma* spp., *Poria* spp. and many others).

- Blights and mildews are caused by fungus attack on the needle or leaf surface. (*Dothistroma*, *Botrytis*)

Of the numerous parasitic fungi found in tropical Asia, the following three are quite common and have economical importance:

- *Armillaria mellea*: This fungus is common in almost all the forest regions of the world, and attacks conifers and broad-leaved species. BROWNE (1968) describes the species as follows:

The fungus commonly exists as a saprophyte in forest soils but, once established on dead wood, it can become an active and virulent parasite. It spreads mainly by means of black, shoe-string-like rhizomorphs and enters living trees and shrubs through their roots or even through sound bark. The principal symptoms are thick layers of white mycelium between the dead bark and the wood and the presence of the characteristic black rhizomorphs. The foliage of the host becomes pale and thin, and conifers exude considerable quantities of resin. The fungus causes a fibrous white rot, in conifers usually confined to the sapwood, but in dicotyledonous trees often affecting the whole heartwood near the base of the bole and extending upwards in a conical column. The disease is favored by high humidity and is particularly dangerous where young conifer plantations have been established soon after the clearing of old, natural, broadleaved forest. The assessment of susceptibility of different tree species is complicated by environmental factors and by the fact that the pathogen appears to exist in the form of a number of strains of varying virulence.

- *Ganoderma lucidum* (syn. *Fomes lucidus*): Also this species is a cosmopolitan parasite found in most temperate and tropical forest regions. It is essentially a wound parasite of broadleaved trees and found less frequently in conifers. Recorded hosts include according to BROWNE (1968): *Acacia auriculiformis*, *Albizia falcata*, *Albizia procera*, *Aleurites moluccana*, *Anacardium occidentale*, *Cassia javanica*, *Cassia siamea*, *Casuarina equisetifolia*, *Delonix regia*, *Eucalyptus citriodora*, *Mangifera indica*, *Pterocarpus*

*indicus*, *Samanea saman*, *Tamarindus indica*. The fungus invades the trees through the roots, especially trees with reduced vitality, and causes a white soft decay in the lower part of the stem. The sporophore, which often appears only after the tree had been killed, is blood-red in color and has a varnish-like crust (11).

- *Dothistroma pini* (Pine needle blight) is found in temperate as well as tropical regions. The disease only infects pines, which show varying resistance depending on species. Infection is most severe in dense overcrowded nursery beds, especially in a humid climate, but the infestation can also spread to young plantations. Characteristic symptoms are chlorosis and necrosis of the needles, especially of the lower branches. The needles wither towards their tips, the basal part remaining green, and the lower needles of a shoot die first, producing a shaving brush appearance. Growth may be considerably retarded or even halted, in heavy infections the mortality of young trees may be high (11).

In the Philippines infestation with *Dothistroma pini* was observed in seedlings of Benguet pine at the Pacdal Nursery, but rarely in young trees of sapling size. *P. caribaea* seems to be quite susceptible to blight especially in a humid climate.

#### Preventive measures.

It is a well accepted fact among plant pathologists, that it is much easier and cheaper to prevent a fungus disease than to cure it. In forestry where a relatively cheap raw material is produced under extensive management, a chemical fungus control in the field would be impossible. This situation is quite different from agriculture where a very unnatural and artificial balance is maintained by extensive use of chemical pesticides. This is also true to some degree for forest nurseries, but for plantations a chemical control of fungus diseases generally is uneconomical. We therefore have to rely almost entirely on preventive measures.

- Site requirements of the species must be properly observed. It is well known, that species outside their optimum habitat,

where growth is somewhat affected, are more susceptible to diseases.

- Planting a tree species in dense and extensive artificial stands, greatly increases the risk of forest diseases. Fungi and insects, which occur only sporadically in a mixed natural forest now multiply enormously because of a vast food supply. Diseases, which affect only sick and dying trees in a mixed forest (secondary diseases), may turn to healthy individuals and become primary pests. For effective prevention it is not necessary to establish o n l y mixed plantations, because they have silvicultural disadvantages, but rely on species mixtures by blocks, which do not exceed a certain size. Mixing different age classes - not necessarily different species - would also greatly reduce the risk of a mass infestation, because some fungus diseases have a marked preference for certain age phases.
- Breeding and propagation of resistant provenances or strains would be a long term project, but offers the best way of preventing forest diseases in the long run.
- Careless logging practices often cause serious injuries to the residual stand. These injuries are often the entrance for fungi which may destroy the entire stem. The official logging instructions (Handbook on Selective Logging, Bureau of Forestry) stress very much the importance of this point.
- An application of a complete fertilizer with trace elements, did in some cases improve the resistance against fungus diseases in plantations and nurseries.
- There are a number of fungi belonging to the group of Urodinales (rusts), which only thrive on alternate hosts. If we destroy the other host plant in the vicinity of the plantation, the fungus cannot complete its life cycle. Many rusts with alternate hosts have been identified in temperate countries. In the tropics, however, the rather complicated relationship between the different stages of the fungus and alternate hosts are not yet fully known for many species. As an example for a heteroecious rust from tropical Asia the bamboo rust (*Dasturella divina*) may be quoted, which depends for its complete life cycle

besides bamboos on the presence of Randia spp., shrubs belonging to the Rubiaceae.

- Where old natural rain forest had been cleared for conifer plantations, heavy attack of *Armillaria mellea* was often observed. Where the attack is extreme other species which offer more resistance must be selected.

## Chapter 23:

### PREVENTION OF INSECT CALAMITIES

#### 23.1 Common insect pests in forest plantations

During recent years there have been more and more reports from different parts of the Philippines, that plantations have been attacked by insects. For example: the mahogany shoot borer has heavily infested mahogany plantations in Nueva Vizcaya, Eastern Mindanao and elsewhere, bark beetles are destroying pines in the Mountain Provinces and the Cagayan Valley, termites are eating newly planted seedlings, defoliators have stripped teak plantations in Nueva Vizcaya.

Research on tropical forest entomology is still in the beginning. Of the many hundreds of harmful forest insects the biology of only a small number had been investigated so far. In the context of this book only a few species, which have economical significance in the Philippines, can be described.

a) Bark beetles

A bark beetle identified as Ips interstitialis, which is native to Central America and the West Indies, has become established in the Philippines after the second world war (11) and is causing extensive damage to Pinus insularis in the Mountain Provinces. Reports about serious outbreaks, which resulted in the death of many trees came from Itogon Reforestation Project, Ambuklao area, the Bobok Concession, Lagangilang Reforestation Project the Cagayan Valley and other places (13). The insect produces many generations a year and a large population is built up rapidly. The beetle is polygamous and the gallery pattern comprises a central nuptial chamber with in the average four radiating mother galleries and larval feeding tunnels.

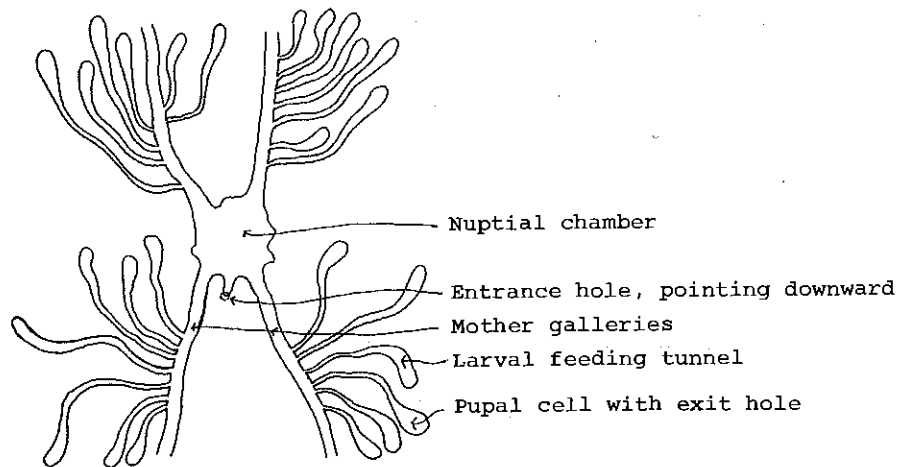

Fig. 38: Typical gallery pattern of bark beetle

Bark beetles are essentially secondary pests, which in the first place attack trees, which had been weakened physiologically after a forest fire or an unusually long dry spell. After the beetles have multiplied in those trees, they may also attack healthy individuals. The same can happen, when

the beetles multiply in logging debris, which soon dries up and forces them to search for other sources of food.

Control

A chemical control of bark beetles on living trees is impossible, we therefore have to concentrate our efforts on preventing an outbreak.

Since trees, which have suffered in a forest fire or long draught, are of magic attraction to the insect, fire prevention would be a very important preventive measures against mass propagation of bark beetles.

Also the site requirements of Benguet pine should be carefully observed and it should not be planted on very dry sites, where the trees offer little resistance towards the insect.

If attack on isolated pines is observed, these should be cut immediately. It was observed in Consuelo Reforestation Project, that beetles and larvas of Ips interstitialis (?) were dead within a few days after cutting the trees, which could be explained by the exposure to high temperatures. The beetles do not seem to transfer to a new tree, after their host has been felled. In high elevations, however, it may be necessary to debark the logs.

Clean logging practices can minimize bark beetle attack in logging areas. In Germany where bark beetles can be a serious problem, all coniferous logs have to be debarked right after felling. A minimum requirement would be to transport felled coniferous logs right after felling to the saw mill site or log pond.

b) Teak defoliator (Hyblaea puera) (6).

The teak defoliator has a very wide natural distribution ranging from Pakistan, the entire Indo-Malayan Region to New Guinea including the Philippines.

Description

The moth has a span of 30 to 40 mm, the forewing shows variable

shades of grey, brown and red with suffused bands of darker color. The hind-wing is dark brown with a curved orange band, which is sometimes broken up into patches. The larva, which reaches a size of 30 to 35 mm, is at first greenish with a dark head, but later become darker with a varying pattern of stripes (6).

Biology: During the day the moths are hiding in dark places. At night they fly and migrate considerable distances. Mating takes place 2-3 days after emerging from the pupa. The female deposits 500 to 600 eggs on the lower side of young foliage.

The larva cuts out patches of the leaves, leaving behind a skeleton of the coarser veins only, young leaves are consumed entirely. In the later stages the larva prepares a shelter by folding over part of the leaf and spinning silk to tie the leaf together. The older larvae consume all soft tissue, so that finally only the midrib and the stiffer side veins remain (the teak skeletonizer in contrast produces a finer pattern).

Pupation takes place in a leaf fold strongly spun together. If not enough leaf material is left, the larva may descend on a silk thread to find new foliage or reach the ground.

Duration of life cycle:

|       |       |            |
|-------|-------|------------|
| Egg   | ..... | 2 - 4 days |
| Larva | ..... | 8 -17 days |
| Pupa  | ..... | 5 -13 days |

The moth has a life span of about 3 months. In a warm climate there can be up to 15 generations a year(6).

Aspects of damage: The pattern of damage in a plantation generally is irregular. There are groups of trees or individuals, which are completely defoliated, while their neighbors are spared entirely.

The intensity of infestation also varies with age. In India according to BEESON (1961) the infestation reaches a maximum in teak plantations of 20 to 30 years, but decreases thereafter rapidly, which coincides with observations in the Philippines.

Though the trees are generally not killed by the defoliator, the increment is greatly reduced. The damage is more serious where young foliage had been destroyed, and not so serious, where defoliation occurred towards the end of the growing season, because the leaves would be dropped anyhow. An almost 100 percent defoliation was observed by the author in 1973 at the Magat Reforestation Project.

Possible ways of control: Chemical control is impracticable, we therefore have to rely on biological and silvicultural control measures. The natural vegetation of the teak area should be partly preserved, because it is important for the life cycle of some of the predators and parasites of the teak defoliators. The mixed natural vegetation contains a number of shrubs and trees, which are the host plants of other defoliators (which do not attack teak). These defoliators on the other side are hosts of parasites, which also destroy the teak defoliator. For conditions in India there exists a list of tree and shrub species, which are important for the life cycles of defoliator parasites and therefore considered desirable. This list includes species of the following genera, which are also found in the Philippines: Cassia, Lagerstroemia, Bauhinia, Eugenia, Ficus, Grewia, Hibiscus, Alstonia, Albizzia, Melastoma, Solanum, Morus, Mangifera.

There are also species, however, which serve as alternate food plants for the teak defoliator and sustain a large number of individuals during the time teak has no leaves. These species are considered to be undesirable near teak plantations. In this list BEESON (1961) includes Gmelina arborea, Lantana camara and species of the following genera: Macaranga, Dolichandrone, Oroxylon, Premna and Vitex.

The best prevention against a widespread attack of the teak defoliator would be the preservation of the natural vegetation along creeks, streams and other sites but eliminating the alternate host plants, where this is possible. In a larger teak area this natural barrier against infestations should occupy not less than 1/5 of the total area. The effectiveness of such natural reservoirs of parasites may be reduced. When abnormal weather

conditions cause a breakdown of the natural control factors and vaor the outbreak of a mass infestation. (6).

- c) Teak Skeletonizer. (Pyrausta machaeralis, syn. Hapalia machaeralis) (6): The natural distribution of this insect coincides more or less with that of the teak defoliator.

Description: The moth has a wing span of 19 to 26 mm, the forewing is yellowish with zigzag markings of varying color. The hind-wing is pale with a reddish or yellowish marginal line. The pattern and the color of the markings are very variable and can differ in different seasons. The larva, which can attain a length of 22 to 25 mm, is at first light green and turns brown or purplish later. The anal claspers or false legs are conspicuous (6).

Biology: A remarkable feature in the population of this insect is, that the females by far outnumber the males. The moths hide during the day in the undergrowth or dead leaves on the ground. Mating takes place the night after mergence from the pupa. About 250 eggs are deposited starting 1-4 days after mating during a period of about one week. The eggs are deposited on both sides of the leaves. The lifespan of the moth is only about one month. The larvas hatch after 3 days and feed under a protective cover of silk. All tissue between the network of veins is consumed leaving only a fine skeleton.

The later stages of *Pyrausta machaeralis* use a silken shelter with an escape hole, which enables them to retreat immediately to the other side of the leaf in case of danger. Pupation takes place in a thick shelter webb with an emergency exit on one side.

Duration of life cycle (6):

|                                    |                 |
|------------------------------------|-----------------|
| Egg .....                          | 3-4 days        |
| Larval period ...                  | 12-14 days      |
| Pupal period ....                  | 5-7 days        |
| Pre-oviposition                    |                 |
| <u>                  period ..</u> | <u>3-4 days</u> |
| Total                              | 23-29 days      |

Aspects of damage: The eggs are deposited on all types of teak leaves, on the tender young leaves as well as the older ones. The larvas are very active and make their own choice after hatching. But in contrast to *Hyblaea puera* the larva of *Pyrausta machaeralis* are able to survive on old brittle leaves, therefore they are still found at the end of the growing season, when *H. puera* is already absent. During the main growing season both insects are often found in association. Regarding the age classes the teak skeletonizer has the same preference as the teak defoliator (6). Control measures: the same as for the teak defoliator.

- d) Mahogany shoot borer (Hypsipyla robusta)

The mahogany shoot borer is a very important insect throughout the tropics of the Old World and does extensive damage to timber trees of the *Meliaceae* family. In the Philippines notably *Swietenia macrophylla* and *Toona calantas* are affected.

Description: The moth reaches a size of 26 to 42 mm, the females being larger than the males, forewing brownish with a black design, hind-wing whitish and pale. The larva, which often changes color during its development reaches a size of 20 to 30 mm.

Aspects of Damage: The attack is commonly noticed on saplings and pole size trees, when the terminal shoot becomes dry and dies back. The result of repeated die-back is the formation of a bushy crown, which retards the height growth and cripples the tree. When the trees become older, they will be forked and branchy. The insect has a marked preference for vigorously growing trees of sapling or pole size with sapy terminal shoots.

The eggs are deposited at the new undeveloped leaves near the tip. The larva feeds at first at the epidermis of the shoot, until it finds a suitable spot to enter. Once established in the shoot it excavates a tunnel in the pith, which may reach 60 cm in length. Sometimes a larva might even attack more than one shoot. On the entire length of the tunnel the shoot dies and breaks off. Within the tunnel the larva constructs

partitions of silk at intervals, which prevent entering of predators, parasites and rain water (6,19).

Possible Control: Since the larva is well protected inside the shoot, chemical control cannot be effective. Cutting and destroying of infested shoots is also difficult in large plantations. Again this leaves only preventive measures.

It had been observed, that especially young vigorously growing trees with sapy terminal shoots had been attacked. This was sometimes the case, where mahogany was planted on very fertile sites resulting in very vigorous height growth. Older trees, however, beyond pole size, which do not produce long terminal shoots any more, are only seldom attacked. On these observations the preventive measures are based:

It is important not to stimulate the growth of mahogany in the early years by fertilizer application. On very fertile sites a light shade of *Albizzia falcata* planted a few years ahead would prevent the formation of long terminal shoots, and render the plants less attractive to the shoot borer. Where infestation is severe BEESON (1961) recommends a close spacing to reduce the development of vigorous lateral branches, which otherwise may be attacked as well. Also mixed planting with ipil-ipil (*Leucaena leucocephala*) in alternate rows could reduce *Hypsipyla* infestation, because the faster growing ipil-ipil provides a beneficial lateral and overhead shade.

From experience in West Africa it appears, that enrichment plantings of *Meliaceae* on cleared lines in secondary forest suffered less from shoot borer attack than open plantations (40).

e) Pine shoot moth

The scientific identity of the pine shoot moth has not yet been established. The insect, which is considerably smaller than the mahogany shoot borer, causes serious and wide spread damage to Benguet pine (13). Infestation takes place mainly during the dry season, between December and May. The infested shoots become limb on the length of the tunnel, then turn brown and fall off. The effect of repeated attack is,

that the pines become very bushy, height growth is retarded, and the trees are crippled. Not only the terminal, but also all lateral shoots can be attacked. Infestation is most severe in pines below 5 meters in height.

From observation it appears, that infestation can reach 100 percent, where Benguet pine is planted below its natural lower limit of distribution, which is about 800 meters above sealevel. The extremely poor shape of Benguet pine planted around 300 to 500 meters above sealevel (Binga, Magat, Lagangilang) can perhaps at least in part be attributed to the pine shoot moth.

The best way of preventing the infestation therefore is to observe the altitudinal limit of Benguet pine and not to plant it on sites lower than 700 to 800 meters in Luzon.

23.2 Natural control factors against insect calamities (6,19).

The population density of noxious forest insects is subject to wide fluctuations. Animal populations in general have a tendency to be in balance with their environment. If the environmental conditions change, the density of the insect population will change too.

Though many of the forest insects have a tremendous reproduction potential, their abundance does not grow without limits. There are natural control mechanisms which inhibit unlimited growth of the insect population. Such natural control mechanisms are for example:

- limited food supply
- host resistance
- climatic factors
- diseases, parasites and predators

All these factors combined constitute the environmental resistance against the outbreak of a pest. If any of these mechanisms fails, we may have to face a calamity.

(a) Limited food supply: In a natural forest the food situation for a specialized insect is not very favorable for

mass propagation. The insect has to cover some distance from one host tree to the next, while it is exposed to predators. The discovery of new host trees, after the supply in one place is exhausted, may present physical difficulties. It may also not be easy to find a mate on widely scattered host plants. The trees even of the same species may belong to different age phases. But many of the important forest insects have a marked preference or even depend on a certain phase of the host. All these factors contribute to the resistance of a heterogeneous forest.

In a dense pure stand without ground vegetation the conditions are just opposite. The insects will encounter a vast concentrated food supply without having to waste energy in searching for food and can multiply enormously. The poorly developed ground vegetation will be unable to support many parasites and predators, which could keep the insect population at bay.

- b) Host resistance: Most trees offer at least some resistance to insect attack. Some species may simply not be palatable to the insect, others may contain substances, which deter certain pests, others again may be resistant as long as they are in good physiological conditions. If healthy pines are attacked by bark beetles, these will be often drowned in a flow of resin. Only after a healthy tree has been weakened by repeated attacks, the insects finally are able to enter. Trees, which have suffered physiologically and especially those, where the cambium is already in a state of slight fermentation, exert a magical attraction to some borers. Trees which exude latex (Moraceae, Sapotaceae) easily repel insects entering through the bark. Generally woods with a high lignin content are quite resistant against termites, those with a low lignin content most susceptible (6).

An indirect resistance to defoliators is also found in teak, which is able to produce a second set of leaves during the same season, after the first had been destroyed, as could be observed during the defoliator outbreak at Magat, 1973.

- c) Climatic conditions: Also the normal climatic conditions have their part in the environmental resistance against a pest. We can feel this clearly in years with exceptional weather conditions, which can often be the ultimate cause for the mass reproduction of destructive insects. Exceptionally dry and hot years may lead to an increase of insects, which are not frequent in normal years. The insects may be able to complete their life cycles faster than normal because of higher temperatures, the hosts may offer less resistance due to draught, losses in the insect population from heavy rains may be reduced parasites may not find their optimum conditions, all factors combined may lead to an outbreak of epidemic proportions.

- d) Diseases parasites and predators play a very important role to keep the population of noxious insects low. The number of the natural enemies of insects is very high, and biological control is mainly the activation of these diseases, parasites and predators. The most important groups according to BEESON (1961) are:

- Fungus diseases: For example, a parasitic fungus, which is important for the biological control of the Coconut beetle (*Oryctes rhinoceros*), is the green muscardine fungus (*Metarrhizium anisopliae*). *Beauveria bassiana* often kills *Hoplocerambyx spinicornis*, a cerambycid beetle that does serious damage to dipterocarps.
- Virus diseases in insects are also known as polyhedral diseases. In the caterpillars of *Hyblaea puera* this is characterized by complete disintegration of the larval tissues which turn into a liquid containing millions of polyhedral particles.
- Parasites of importance include mainly wasps of the Ichneumonidae and Braconidae. Both large groups of Hymenoptera are well represented in the Philippines. Their hosts include larvae and pupae of Lepidoptera and sometimes wood boring Coleoptera. The eggs are deposited on the host, the larvae feed outside or inside the host and pupate later inside the body or the cocoon of the dead host.

Because of their high reproduction potential these wasps have a very important function in the natural control of lepidopterous pests such as the teak defoliator.

- Predators: There are numerous insects preying on other insects, they also play their part in the environmental resistance against mass reproduction, namely mantids ("walking stick"), dragon-flies, certain wasps, some Coleoptera, spiders, and perhaps most important because of their number, some species of ants. One group of ants, the Ponerinae, has specialized on insects entirely.

Almost all species of birds, even the graminivorous species feed on insects at least during part of the year when feeding their offspring. Nestling consume more than their own weight in insects every day.

In Europe a pair of titmice (*Parus major*), a little bird similar to the Philippine titmouse (*Parus elegans*), which breeds twice a year and feeds entirely on insects, with its offspring is estimated to consume 100 kg of insects during one year.

In spite of the huge quantities of insects devoured by birds their importance in natural control should not be overestimated as pointed out by BEESON. While the parasites like Ichneumonidae and Braconidae are able to multiply along with the mass reproduction of noxious insects, the density of the resident bird population cannot increase quick enough, and may be powerless to check the violent fluctuations in the occurrence of insects.

Usually a mass propagation of insects is followed by an increase of diseases, parasites and predators, which will finally gain control and keep the noxious insects down for some time. But then with the number of hosts diminishing, the parasites and predators also become less and the insect population can built up again. So the cycle of mass propagation recurs presenting an oscillating curve. A chemical control at the height of an epidemic is generally not recommended, because apart from the high cost, it

only prolongs the natural course of the epidemic and kills the useful parasites and predators as well.

For more information on forest insects and their control in tropical Asia consult BEESON (1961) on whose work this chapter is partly based.

Chapter 24:

#### RODENT CONTROL IN PLANTATIONS

Rodents can be a serious menace to plantations especially where a new species had been introduced. Damages are usually high on warm southern slopes with a thick cover of dry grasses.

The rat or mouse often eats at the base of the seedling either killing it by girdling or bringing it to fall and then eating the green shoots and leaves.

It was observed that especially species that were newly introduced to an area become easily the victim of rodents. In Binga during the heavy infestation of 1970/71, rodent damage was observed on mango, nangka, alibangbang, kalantas and occasionally even on pines.



As insect populations, also the rodent population is subject to violent fluctuations. The reasons are not yet fully understood.

Possibilities of rodent control:

24.1 Poisoning: Where only an isolated plantation of limited extent is to be protected, poisoning may not give the desired result in the long run because of new invasion from surrounding areas. Poisoning therefore generally works better on a larger scheme, where also cost per unit of area is lower.

There are two groups of rat poison available: acute poisons like zinc-phosphide and chronic poisons such as Coumatetralyl or Chlorophacinone, which is known under the trade name Racumin.

Acute poisons are generally used in the initial stage of rodent control to knock down a high rat population. But the rats soon develop a bait shyness, because the animals die right after feeding on the poison. For forestry purpose the chronic poisons such as Racumin seem to be preferable.

Racumin which contains 0.5% active poison is mixed with corn grit ("binlid" or "pegpeg") at a rate of 75 g to one kilogram of grit.

Containers or baiting stations: To avoid damage to livestock and to protect the bait from rains, the poisoned bait is placed in so-called baiting stations. Very convenient are bamboo tubes at least 12 cm wide, which had been prepared by cutting half of the dividing internodes on both ends as illustrated below.

After the containers have been half filled with the bait, they are placed on supporting sticks about 4 cm above the ground. To make them more enticing to the rodents, they are covered with dry grass as a camouflage. The location is marked with a guide pole. The average distance between the baiting stations should be about 50 m, but slightly closer towards the edges of the plantation. The baits have

to be inspected once a week, and consumed bait is to be replaced. It takes 3-4 days for the rats to die after feeding on the poison.

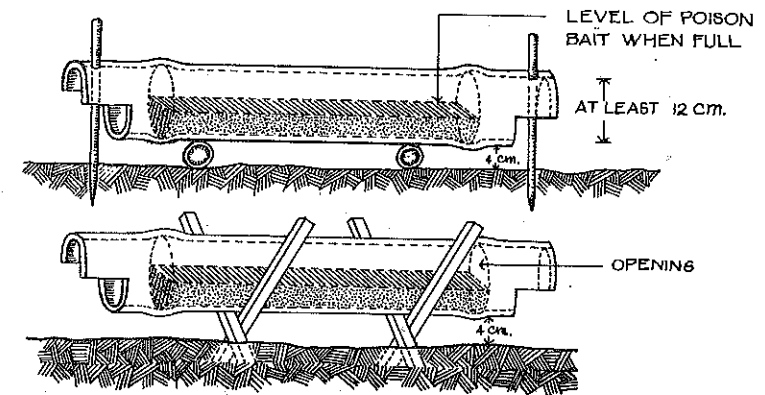

Fig. 39: Placing of baiting stations in the field

24.2 Repellents: Where only a few seedlings have to be protected, repellents may be quite effective without having to start a poisoning campaign. Repellents can be prepared from a mixture of cows urine or cows blood, slaked lime, coarse sand and a bright dye (blue or yellow). This mixture, which is harmless for the seedlings, is painted to the stem with the help of a double brush during dry weather.

24.3 Other protective measures: Protecting the lower stem of the endangered species seems to work quite well, because some of the rodent species apparently do not climb. A suitable and cheap protection would be split bamboo tubes about 25 cm long where the internodes had been removed. The two halves of the tube are placed around the seedling and tied together with string (fig. 40).

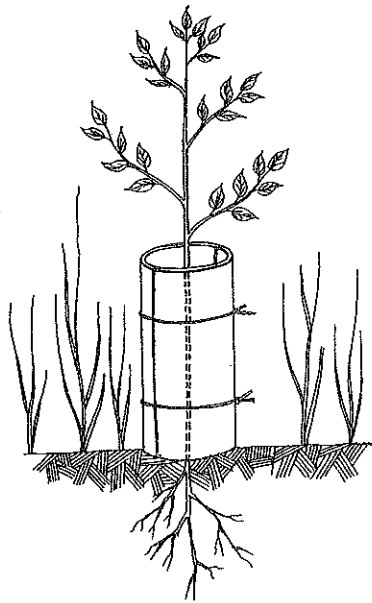

Fig. 40: Rodent protection with a bamboo tube

Chapter 25:

CONFLICTS BETWEEN FORESTRY AND CATTLE RANCHING

25.1 Aspects of damage by cattle ranching

The Philippine rules for land classification specify, that land over 18 percent slope is to be declared as permanent forest or forest reserve, but pasture leases can be granted for land up to 50 percent slope. This implies, that on land between 18 and 50 percent slope both forms of land-use have to exist side by side, and there is bound to be a conflict of interests between forestry and range management. In practice, however, in addition grazing is found on slopes even

exceeding 50 percent extending well into the domain of the protection forests.

The damage done by the grazing animals themselves is generally small compared to the damage done by pasture burning. Since most pastures consist of cogon (*Imperata cylindrica* and *I. exaltata*), they are burnt annually to induce fresh growth of palatable young shoots. This practice is not found only in the Philippines, but common throughout the tropics.

The damage done to forests and watersheds by the annual fires exceeds the meager returns from meat production several times, because many areas have only a carrying capacity of one cow for 5 hectares or even less.

In the pine region of Northern Luzon the impact of the fires originating mainly from pastures can be clearly seen. All the young natural regeneration and a few of the large trees are killed each year. As a result the stands have become very open or have disappeared completely. While on the other side it is likely, that the natural regeneration of Benguet pine is favored by occasional fires exposing the mineral soil, annual fires will definitely destroy it.

Compared to the damage by fires, the damage by browsing is relatively small, as long as goats do not enter the scene. Goats are most destructive eating almost everything. They are able to reach relatively high into the trees, when the ground vegetation is depleted. Cows, carabao and horses do much harm by trampling because of their weight.

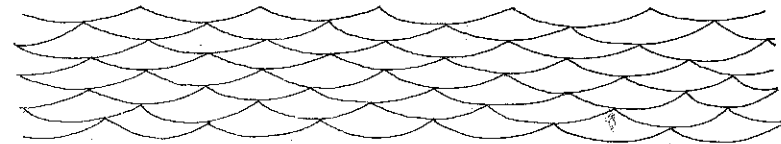

Fig. 41: Pattern of browsing trails in overgrazed pasture land in the hills

Overgrazed slopes with too many animals show a definite honey comb pattern of browsing trails visible from a distance. In

these trails the water accumulates, and they become the starting point for erosion.

## 25.2 Possible solutions.

- a) All pasture licensees should be required to fence their pastures and adopt a system of rotational grazing.
- b) Burning of pastures in forest areas is to be strictly prohibited. Pasture licensees outside the forest areas have to obtain a burning permit and are required to construct fire lines. The licensee is to be held responsible for any fire spreading from his pasture into plantations or other forest areas.
- c) Grazing and forestry have to be separated because of their conflicting interests. In neighboring Taiwan no grazing is permitted in forest areas. In C. Europe, where forests were suffering under the burden of traditional grazing rights, the separation was accomplished during the 19th century. As a long term policy goal the same is suggested for the Philippines.

As a first step a revision of all existing 3636 pasture leases (figure of 1972) is suggested to investigate, if they really meet the requirements set forth in the Philippine forest laws. All leases on unsuitable land must be offered a transfer to more suitable areas or cancelled.

- d) The remaining pastures have to be improved in a way that they do not need burning. This is possible by introducing valuable African forage grasses such as *Pennisetum purpureum*, *Panicum maximum* and others. Another possibility would be the cultivation of leguminous trees such as ipil-ipil (*Leucaena leucocephala*) and its giant variety or catúrai (*Sesbania grandiflora*), whose foliage is nutritious and provides excellent forage. "Tree pasture" would be suitable for beef and milk cattle likewise. For more information on this subject consult Chapter 5.5, Part V of this book.

## REFERENCES

- (1) ANDRES, P.P., 1969, Pulp and paper industry in the Philippines. Reforestation Monthly VIII (4-5), Manila
- (2) ANDRES, P.P., 1969, Field planting methods and techniques. Reforestation Monthly XIII (9-10), Manila
- (3) ANDRES, P.P., 1970, Approaches to our reforestation problems. Reforestation Monthly IX (10-12), Manila
- (4) BARNARD, R.C., 1956, A manual of Malayan silviculture for inland lowland forests. Part IV: Artificial regeneration. Research Pamphlet No. 14, FRI, Kepong, Malaysia
- (5) BAULE, H. et FRICKER, C., 1970, The fertilizer treatment of Forest Trees BLV. Munchen
- (6) BEESON, C.F.C., 1961, The ecology and control of the forest insects of India and the neighbouring countries. Govt. of India, N. Delhi
- (7) BINUA, T.M., 1969, Stump and seedling planting of teak in Cebu and Bohol. Reforestation Monthly VIII (7-8), Manila
- (8) BINUA, T.M., 1970, A primer on tree surgery. Reforestation Monthly IX (4-5), Manila
- (9) BREWBAKER, J.L., PLUCKNETT, D.L., GONZALES, V., 1972 Varietal variation and yield trials of *Leucaena leucocephala* (Koa Haole) in Hawaii. Hawaii Agric. Exp. Station, Research Bull. 166
- (10) BROWN, H.W., 1920, Minor products of Philippine forests. Manila, 2 Vols.
- (11) BROWNE, F.G., 1968, Pests and diseases of forest plantation trees. Clarendon Press, Oxford, 1330 pages

- (12) BUREAU OF FORESTRY, 1970, Handbook on selective logging. 2nd Ed. Manila
- (13) CALEDA, A.A. et VERACION, V.P., 1960, New insect pests of Benguet pine. Philipp. Journal of Forestry XVI (1-2), Manila
- (14) CATINOT, R., 1965, Sylviculture tropical en forêt dense africaine. Bois et Forêt Tropiques, No. 100-104
- (15) CHAMPION, H.G. et GRIFFITH, A.L., 1960, Manual of general silviculture for India, New Delhi
- (16) CHAMPION, H.G. et BRASNET, N.V., 1958, The choice of tree species. FAO Forestry Development Paper No. 13, Rome
- (17) COOLING, E.N.G., 1968, Pinus merkusii, Commonwealth Forestry Institute Oxford
- (18) DAWKINS, H.C., 1958, The management of natural tropical high forest with special reference to Uganda. CFI, Oxford
- (19) DEBACH, P., 1970, Biological control of insect pests and weeds. Chapman and Hall Ltd., London
- (20) DEICHMANN, V. Von, 1967, Noções sobre sementes e viveiros florestais. Curitiba/Brasil
- (21) DELIZO, T.C., 1964, Forest nursery and plantation handbook for the Philippines U.P. College of Forestry Los Baños
- (22) DOMINGO, I.L., 1966, Survival and growth of Moluccan sau in Mt. Makiling as affected by planting, spacing and kind of planting materials. Forestry Leaves 17 (2-3)
- (23) DOWNING, A.J., 1859, Theory and Practice of landscape gardening. 6th Ed., Funk and Wagnalls, New York
- (24) ESCOLANO, J.O., NAVARRO, J.R., VISPERAS, R.V., 1974 Kraft pulping of some Philippine non-commercial hardwoods. The Philippine Lumberman, July 1974
- (25) FONTANILLA, F., 1969, Minimizing forest fires through extension services. Reforestation Monthly IX (4-5), Manila
- (26) FOOD AND AGRICULTURE ORGANIZATION OF THE UNITED NATIONS, 1967, An international review of forestry and forest industries. Unasylva XXI (86/87), Rome
- (27) FOOD AND AGRICULTURE ORGANIZATION OF THE UNITED NATIONS, 1970, Fertilizers and their use. Rome
- (28) FOOD AND AGRICULTURE ORGANIZATION OF THE UNITED NATIONS, 1971, Demonstration and training in forest, forest range, and watershed management. Technical Reports No. 1-7, 9, 10
- (29) GANGULY, J.K. et KAUL, R.N., 1969, Wind erosion control Indian Council of Agricultural Research, Tech. Bul. No. 20 New Delhi
- (30) GOOCH, W.L., 1953, Forest industries of the Philippines. Bureau of Forestry and United States Mutual Security Agency Manila
- (31) GOOR, A.Y., 1963, Tree planting practices for arid zones. FAO Forestry Development Paper No. 16, Rome
- (32) GOZE, R. et BRIONES, R., 1970, Forest Fires: protection and control mimeographed, Bureau of Forestry
- (33) GUSSONE, H.A., 1964, Faustzahlen für die Düngung in Walde. (guide lines for fertilizer application in forests)
- (34) HENGST, X., 1954, Praktische Kultur- und Jungwuchspflege (the practice of tending) Schriftenreihe "Waldarbeit leicht gemacht" Heft 9
- (35) HESMER, H., 1966, 1970, Der kombinierte land- und forstwirtschaftliche Anbau. Part I: Tropisches Afrika, Part II: Tropisches und Subtropisches Asien. Wissenschaftliche Schriftenreihe des BMZ No. 8 & 17, Bonn
- (36) JACALNE, D.V., 1960, Edible fruit bearing trees of the Philippines. Forestry Leaves XII (1)
- (37) JUNG et RIEHLE, Beurteilung und Behebung von Ernährungsstörungen bei Forstpflanzen.
- (38) KIMBALL, E., 1969, Critical fire control problems threaten Cordillera, Zambales Mountains. Reforestation Monthly VIII (3)

- (39) KURATORIUM FÜR WALDARBEIT UND FORSTTECHNIK, 1971, Chemische Kultur und Jungwuchspflege mit Herbiziden. Forstarchiv 42 (5)
- (40) LAMB, A.F.A., 1972, Tropical pulp and timber plantations. Paper No. 46, 7th World For. Congr. Buenos Aires.
- (41) LAMB, A.F.A., 1973, Gmelina arborea. Series: Fast growing timber trees of the lowland tropics. Oxford
- (42) LETOURNEUX, C., 1957, Tree planting practices in tropical Asia. FAO Forestry Development Paper No. 11, Rome
- (43) LEWIS, N.B., 1962, Some effects of thinning on value production. Australian Forestry 26 (1)
- (44) LIEBENEINER, E., 1968, Bekämpfung von Waldbränden, Moorbränden, Heidebränden. Kohlhammer Verlag Stuttgart
- (45) LIZARDO, L. et CALEDA, A.A., 1959, Survival of pines in grass fires. Bureau of Forestry Research Note No. 51, Manila
- (46) LIZARDO, L., 1960, Results of trial plantings of Eucalyptus in the Philippines. Philippine Journal of Forestry XVI (1-2)
- (47) LOYCKE, H.J., 1963, Die Technik der Forstkultur. BLV München
- (48) McCLURE, F.A., 1966, The Bamboos
- (49) MACMILLAN, H.F., 1956, Tropical planting and gardening. London
- (50) MAURICIO, F.P., 1957, A preliminary study on the behavior of wild dipterocarp seedlings when transplanted in the forest. Philipp. Journal of Forestry 13 (3-4)
- (51) METRO, A., 1955, Eucalypts for planting. FAO Forestry and Forest Products Studies No. 11, Rome
- (52) MONSALUD, M.R., 1968, Traditional and new uses of Philippine woods. Forestry Leaves XVIII (3)
- (53) MONSALUD, M.R. 1971, Possible solution to kaingin problems. The Philippine Lumber Man, April 1971
- (54) MÜLLER, R., 1959, Grundlagen der Forstwirtschaft. Hannover

- (55) PARRY, M.S., 1956, Tree planting practices in tropical Africa. FAO Forestry Development Paper No. 8, Rome
- (56) PHILIPPINE COUNCIL FOR AGRICULTURAL RESEARCH (PCAR), 1975, Philippines recommends for the production of fast growing hardwoods. Los Baños
- (57) PRESIDENTIAL COMMITTEE ON WOOD INDUSTRIES DEVELOPMENT, 1971, Philippine forestry and wood industries development. Agr. Inf. Div., Manila
- (58) REFORESTATION ADMINISTRATION, 1968-1971, Annual Reports No. 9-11 Manila
- (59) SABADO, E., 1969, An annotated bibliography of forest tree diseases in the Philippines. Bureau of Forestry, Occasional paper No. 33
- (60) SCOTT, C.W., 1960, Pinus radiata. FAO Forestry and Forest Products Studies No. 14, Rome
- (61) SMITH, D.M., 1962, The practice of silviculture. New York
- (62) STEINER, M.L., Philippine ornamental plants. Manila
- (63) SURI, P.N., 1959, Tree planting practices in temperate Asia. FAO Forestry Development Paper No. 14, Rome
- (64) TOUMEY, J.W. et KORSTIAN, C.F., 1967, Seeding and planting in the practice of forestry. 3rd Edition
- (65) VIADO, J., 1970, Problems and policies on forest conservation. Reforestation Monthly IX (1-3), Manila
- (66) WHITFORD, H.N., 1911, The forests of the Philippines. Manila, 2 Vols.
- (67) WORMALD, T.J., 1969, A nursery handbook for the Philippines. Reforestation Administration, mimeographed
- (68) WORMALD, T.J., 1969, Experiments undertaken in cooperation with the Reforestation Officer. Ref. Administration, mimeographed
- (69) WIEDEMANN, E., 1951, Ertragskundliche und waldbauliche Grundlagen der Forstwirtschaft. 3 Parts
- (70) WYATT-SMITH, J., 1963, Manual of Malayan silviculture for inland forests. Malayan Forest Record No. 23, 2 Vols., Kuala Lumpur

P A R T III

ELEMENTARY COMPASS SURVEYING AND MAPPING

J. GUMAYAGAY and S. FESTIN

Chapter 1:

COMPASS SURVEYING AND RECORDING OF FIELD DATA

Basic knowledge of forest surveying and mapping is indispensable for efficient planning and management in reforestation, like in any field project in forestry.

The first step in the establishment of a reforestation project is the planting survey, after which a map has to be prepared. Only after an adequate survey the area can be divided into blocks and compartments or sub-compartments. As the project progresses, a series of surveys are carried out for planning and management purposes.

For all such survey works, the forestry box compass is of very practical use. In special cases, a more precise instrument has to be used, but where a compromise between speed and accuracy is acceptable, the Bureau of Forest Development has adopted the forestry box compass as a standard surveying instrument.

The following guide, which deals solely with elementary compass surveying and mapping, is intended for use in refresher courses. It is based mainly on the Manual of Procedure of the former Bureau of Forestry.

a) General orientation:

Consult a land classification (L.C.) map or any forestry map to get an idea about the location of the area to be surveyed. Determine at least two possible tie points, preferably forest zone corners or natural land marks like junctions of rivers,

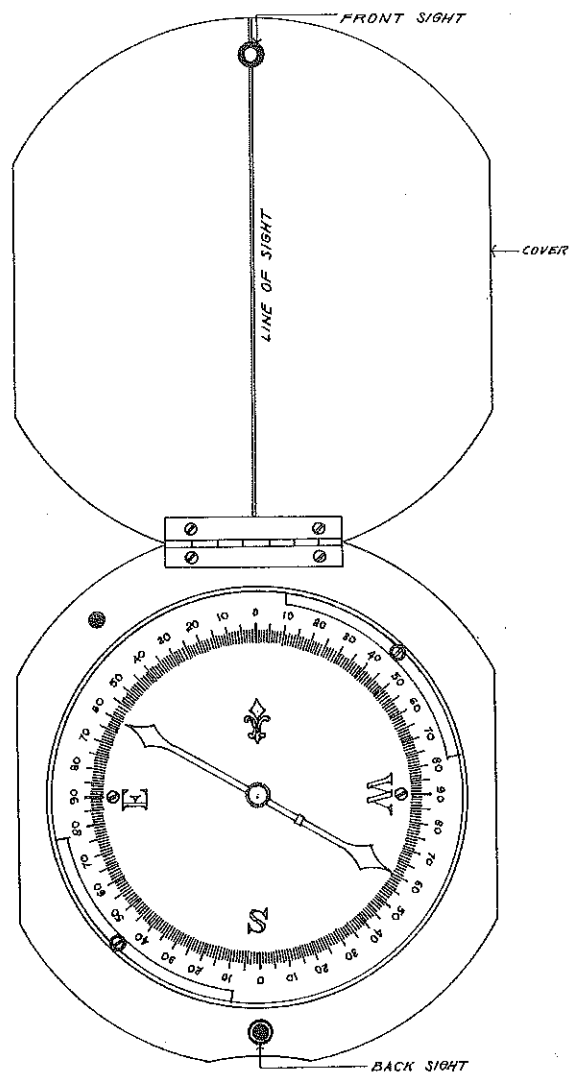

Fig. 1: The Forestry Box Compass

roads or trails shown in the map. Sketches of adjacent areas previously surveyed, if any, are likewise useful references.

b) Index numbers:

Each survey conducted has to be assigned an index number for reference purposes. Get the allocation of index numbers from the District Forester, Forester in Charge or Officer in Charge who must always keep records of index numbers issued to or used by personnel under them.

c) Tie points:

Before starting to survey, orient yourself with the area and locate your tie points. As a general practice, a survey must start from a point known in the map and later on tied to another as a check of accuracy. For that matter, if a survey starts from a point unknown in the map, it has to be tied to at least two known points.

d) Field notes:

Start supplying the information needed in the field note cover and in the field note itself; the rest upon completion of the survey (see fig. 2). As a rule, recording of field data starts from below. At the bottom of the field note, write station 1 and its description. Example: Molave, 30 cms diameter, at the junction of Balincaguin River and Mapitpit Creek, Bo. Villacorta, Mabini, Pangasinan; or Corner 4, Alienable and Disposable Block I, L.C. Project No. 10, Olongapo, Zambales.

e) Recording of compass bearing:

Occupy station 1, facing in the direction of station 2. Hold the compass steady in both hands with elbows pressed against the body. Then sight station 2 by pointing the front sight of the compass (see Fig. 1) to the station observed. When the needle stops oscillating, read the bearing quickly to the nearest degree. Record the compass reading under the column provided for, in line with station 1-2. In using the compass, see to it that it is free from the effect of magnetism due to iron objects carried by yourself or in nearby surroundings.





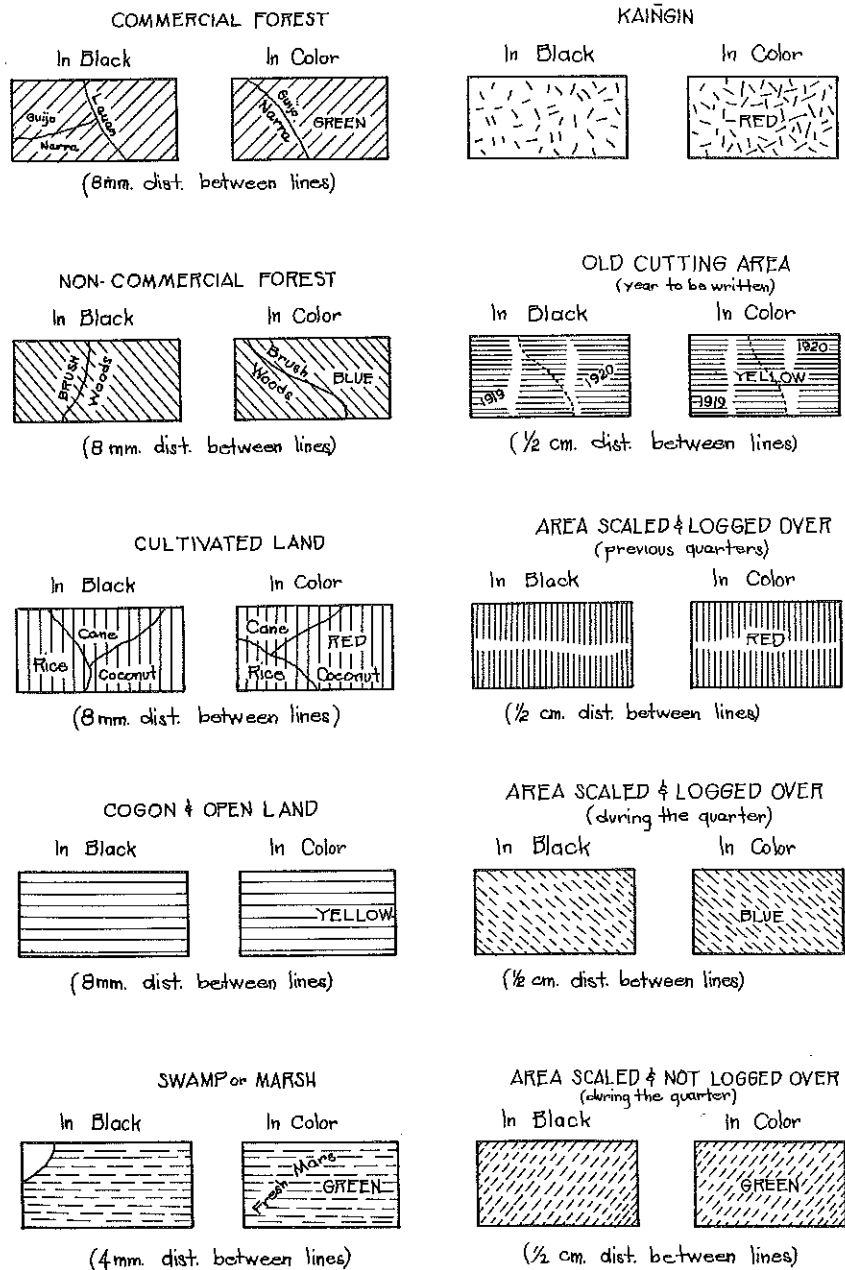

Fig.3: Conventional Signs for Field Sketches

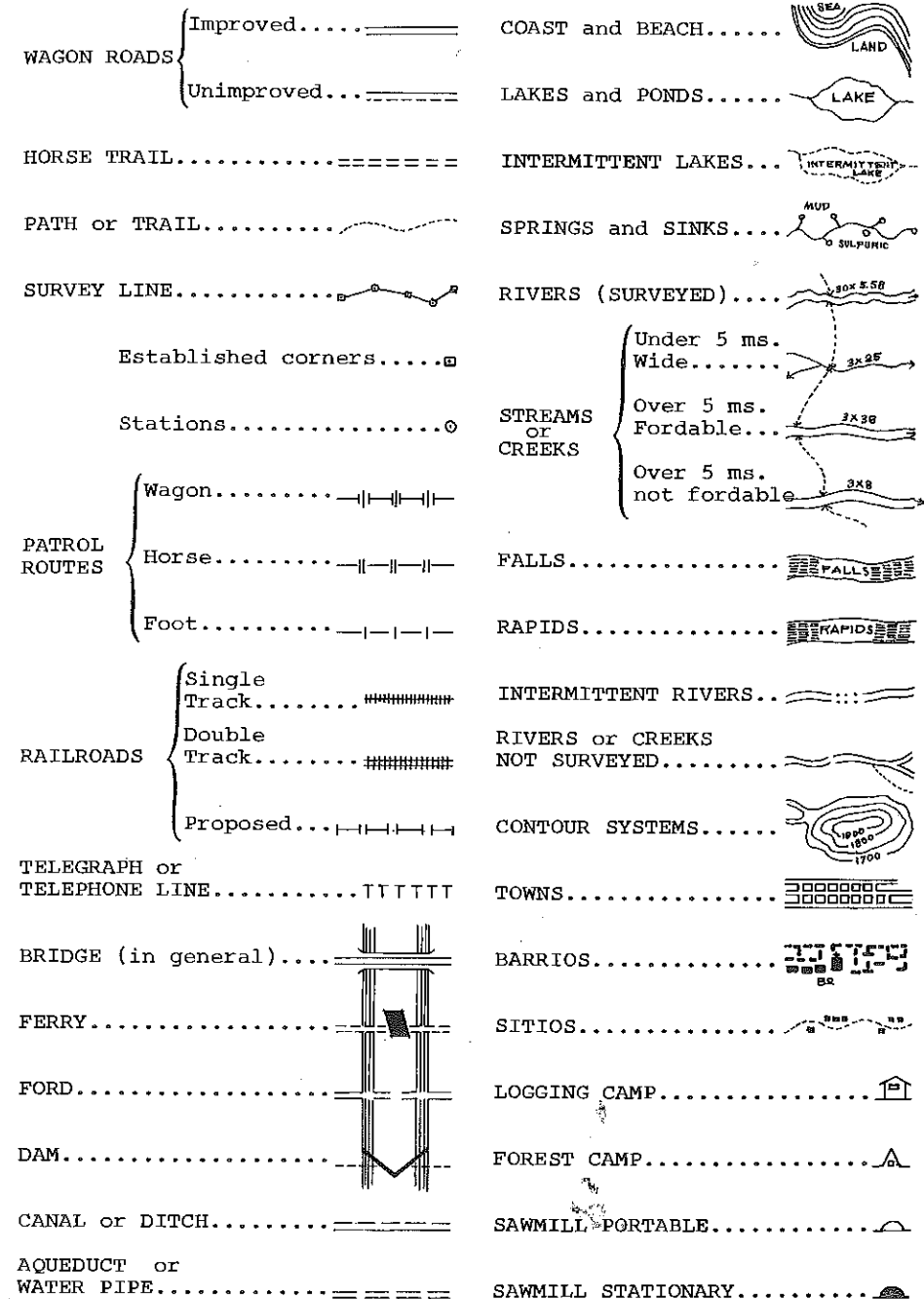

Fig.3 (continued): Conventional signs for field sketches











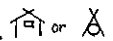

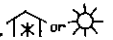

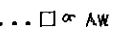





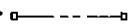

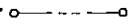
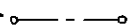







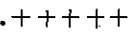

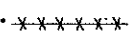
|                                   |                                                                                                        |                                            |                                                                                                                                                                                                                                                                                                                                                                                                   |                    |                                                                                      |          |            |                                                                                      |          |                   |
|-----------------------------------|--------------------------------------------------------------------------------------------------------|--------------------------------------------|---------------------------------------------------------------------------------------------------------------------------------------------------------------------------------------------------------------------------------------------------------------------------------------------------------------------------------------------------------------------------------------------------|--------------------|--------------------------------------------------------------------------------------|----------|------------|--------------------------------------------------------------------------------------|----------|-------------------|
| WINDMILL.....                     |                       | BUILDING.....                              |  S.M.                                                                                                                                                                                                                                                                                                           |                    |                                                                                      |          |            |                                                                                      |          |                   |
| WATER POWER MILL.....             |                       | CHURCH.....                                |                                                                                                                                                                                                                                                                                                                |                    |                                                                                      |          |            |                                                                                      |          |                   |
| ARTESIAN WELL.....                |                       | CEMETERY.....                              |                                                                                                                                                                                                                                                                                                                |                    |                                                                                      |          |            |                                                                                      |          |                   |
| FOREST DISTRICT HEADQUARTERS..... |                       | BUREAU of LANDS<br>LOCATION MONUMENT... .. | BLLM No. 10                                                                                                                                                                                                                                                                                                                                                                                       |                    |                                                                                      |          |            |                                                                                      |          |                   |
| FOREST STATION.....               |                       | Km. Post (PROVINCIAL<br>or NATIONAL).....  |                                                                                                                                                                                                                                                                                                                 |                    |                                                                                      |          |            |                                                                                      |          |                   |
| FIRE WARDEN STATION.....          |                       | PROVINCIAL BOUNDARY.....                   |                                                                                                                                                                                                                                                                                                                 |                    |                                                                                      |          |            |                                                                                      |          |                   |
| PATROLMAN STATION.....            |                       | SUB-PROVINCIAL<br>BOUNDARY.....            |                                                                                                                                                                                                                                                                                                                 |                    |                                                                                      |          |            |                                                                                      |          |                   |
| FOR SCALE<br>1:100,000            | EXPERIMENTAL<br>NURSERY.....                                                                           | MUNICIPALITY or<br>TOWNSHIP.....           |                                                                                                                                                                                                                                                                                                                 |                    |                                                                                      |          |            |                                                                                      |          |                   |
|                                   | PERMANENT<br>NURSERY.....                                                                              | PRIVATE STATE LINES.....                   |                                                                                                                                                                                                                                                                                                                 |                    |                                                                                      |          |            |                                                                                      |          |                   |
|                                   | SILVICAL<br>EXPERIMENT.....                                                                            | VALUATION SURVEY<br>LINES.....             |                                                                                                                                                                                                                                                                                                                 |                    |                                                                                      |          |            |                                                                                      |          |                   |
| MINES AND QUARRIES.....           |                       | COOPERATIVE WATERSHED.....                 |                                                                                                                                                                                                                                                                                                                 |                    |                                                                                      |          |            |                                                                                      |          |                   |
| MINE PROSPECT.....                |                       | BURNED AREA.....                           |                                                                                                                                                                                                                                                                                                                 |                    |                                                                                      |          |            |                                                                                      |          |                   |
| COAL OUTCROP.....                 |                       | FIRE LINE.....                             |                                                                                                                                                                                                                                                                                                                 |                    |                                                                                      |          |            |                                                                                      |          |                   |
| MINE ENTRANCE.....                |                     | FENCES (in general).....                   |                                                                                                                                                                                                                                                                                                               |                    |                                                                                      |          |            |                                                                                      |          |                   |
| BENCH MARK with elevation... ..   |  $\frac{B.M.}{200}$ | BOUNDARY of                                | <table border="0"> <tr> <td>ALIEN. or<br/>DISP.</td> <td></td> <td>OLD LINE</td> </tr> <tr> <td>TIMBERLAND</td> <td rowspan="2"></td> <td rowspan="2">NEW LINE</td> </tr> <tr> <td>FOREST<br/>RESERVE</td> </tr> </table> | ALIEN. or<br>DISP. |  | OLD LINE | TIMBERLAND |  | NEW LINE | FOREST<br>RESERVE |
| ALIEN. or<br>DISP.                |                    |                                            |                                                                                                                                                                                                                                                                                                                                                                                                   | OLD LINE           |                                                                                      |          |            |                                                                                      |          |                   |
| TIMBERLAND                        |                    |                                            |                                                                                                                                                                                                                                                                                                                                                                                                   | NEW LINE           |                                                                                      |          |            |                                                                                      |          |                   |
| FOREST<br>RESERVE                 |                                                                                                        |                                            |                                                                                                                                                                                                                                                                                                                                                                                                   |                    |                                                                                      |          |            |                                                                                      |          |                   |
| LIGHTHOUSE.....                   |                     |                                            |                                                                                                                                                                                                                                                                                                                                                                                                   |                    |                                                                                      |          |            |                                                                                      |          |                   |
| ANCHORAGE.....                    |                     |                                            |                                                                                                                                                                                                                                                                                                                                                                                                   |                    |                                                                                      |          |            |                                                                                      |          |                   |

Fig. 3 (continued): Conventional signs for field sketches

Commercial and Non-Commercial Forest



Non-Commercial and Brush

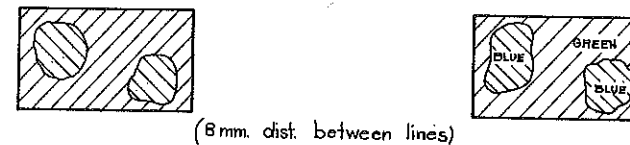
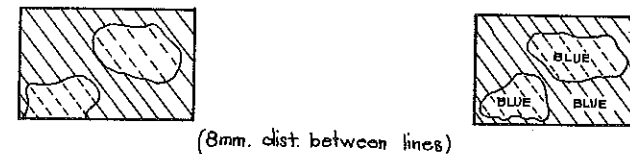

Cogon or Open Land and Brush

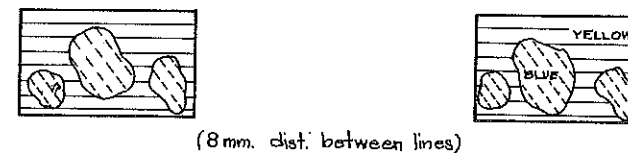

Cogon or Open Land and Cultivated

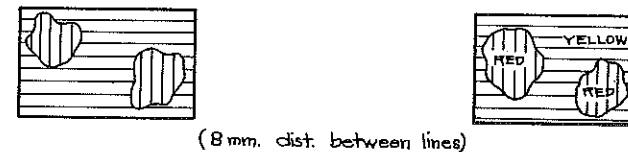

Non-Commercial and Cogon or Open land

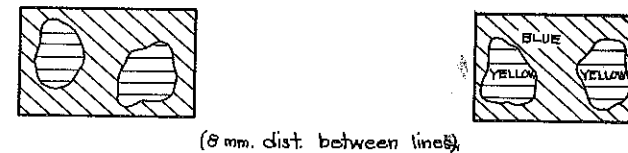

Fig. 4: Conventional Signs for Mixed Vegetative Cover

Then indicate the details traversed.

Repeat the process as you proceed to succeeding stations. Sketching proceeds as the survey progresses. When the first sheet of field note is filled up, continue recording the data on another sheet, and continue sketching at the back of the first sheet of field note.

h) Corner points:

Enclose with a square, each station established as corner, in the field note as well as in the sketch. Opposite such a station, under column "note", place the description of the corner, indicating its relative location with respect to any physical feature nearby like, "Benguet Pine, 50 cms., on top of ridge" or "BFD cylindrical concrete monument, 15 cm diameter, east bank of river". Each tree designated as corner should be legibly marked in chisel or timber crayon, without causing much injury, indicating the objective of the survey, the corresponding index number and station number as illustrated below:

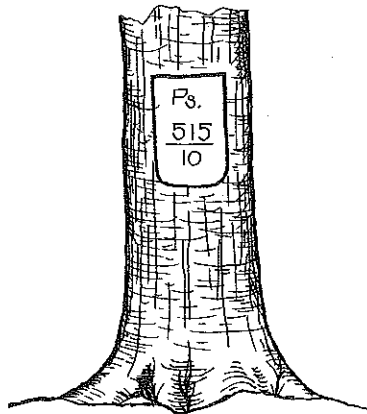

Ps. - Pasture survey  
515 - Survey index number  
10 - Station number

Fig. 5: Corner point established on a tree.

This tree has to be marked also with the marking hatchet used by the forest officer performing the survey.

i) "Side - shots":

For accuracy in taking details encountered in the survey, side-shots have to be made. To make a side-shot, occupy a convenient station, then get the bearing and distance of the point being surveyed. Where measuring the distance is too inconvenient or impractical, determine the relative location of that point or feature by "triangulation", which is done by taking the bearings of this point from two stations conveniently located. When the bearings are plotted, the intersection is identical to the point sighted.

j) Large surveys:

As a rule, change the index number and renew the numbering of stations starting again from "1" when the distance surveyed reaches approximately six kilometers, so that the survey when plotted, can be well accommodated in the standard size of plotting paper which is 23 x 30 centimeters. For that matter, several index numbers may be needed to complete a survey project. After plotting, the individual surveys are compiled together in the same sheet of mapping paper of convenient size.

MAPPING SCALE, PLOTTING OF FIELD NOTES AND TRACING THE SKETCH

2.1 The Map Scale.

Ground measurements have to be reduced in size or else they cannot be accommodated on paper, hence, the necessity of scale in mapping. The scale shows the map as a projection in proportion to its actual size on the ground. It is only through the reduction at a certain scale that maps of convenient size can be produced.

In forestry the scales most commonly used are 1: 5,000, 1: 10,000 and 1: 20,000. 100 meters in the field are represented on a map:

|         |          |          |
|---------|----------|----------|
| 1:5,000 | 1:10,000 | 1:20,000 |
| 2 cm    | 1 cm     | 0.5 cm   |

2.2 Plotting of field notes.

For each index number or survey, use 23 x 30 cm cross-section paper. Select an appropriate scale so that when plotted, the survey is well contained on the paper, and all important details can be indicated clearly. The scale of 1:20,000 is generally used in forestry, except in really small surveys where smaller scales have to be used to allow space for important details. The smaller the scale, the bigger the resulting map of a certain ground measurement.

Always consider the top of the plotting paper as north. Place a temporary mark on the upper right hand corner in-

dicating the north and the scale adopted to avoid confusion.

Before starting to plot, examine the field notes and the field sketch to determine the length and the general direction of the survey. This will enable one to plot the sketch more or less at the center of the paper by starting on the side opposite the general direction of the survey.

Mark the station by a dot on the plotting paper. To plot a line with the bearing in the NE or SE direction, place the base line of the protractor towards the East; reverse the position, if the bearing is in the NW or SW direction. Adjust the position so that the intersection of the horizontal o-p-o line and the vertical p-90° line or point p of the protractor coincides with the station marked by a dot on the plotting paper. The graduations of the plotting paper will serve as guide in adjusting the protractor to the desired position.

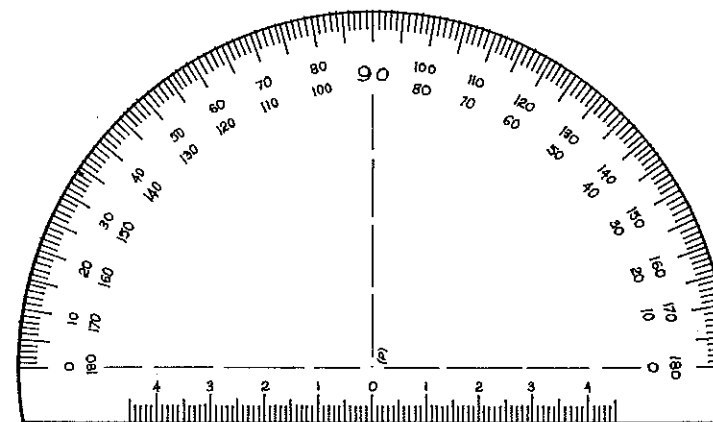

Fig. 6: Protractor

Depending on the general direction of the line to be plotted, read the bearing from the:

|              |     |             |    |           |
|--------------|-----|-------------|----|-----------|
| 1st quadrant | - - | when in the | NE | direction |
| 2nd          | "   | - -         | "  | "         |
| 3rd          | "   | - -         | "  | "         |
| 4th          | "   | - -         | "  | "         |

Then mark the reading or bearing by a light dot, called "guide dot". With the "0" graduation of the millimeter scale over station 1, and its edge tangent to the "guide dot", plot the distance between stations "1" and "2" according to the scale adopted. The procedure is repeated until all the stations of the survey are plotted. Indicate the stations established as corners of the area surveyed by enclosing them with squares.

Also plot the tie points, and connect them with tie lines, preferably to the nearest corners of the area surveyed. Indicate their bearings and distances with respect to such corners. If the tie points are too far that plotting them is impractical, show their relative locations by tie lines, also indicating their bearings and distances.

In indicating the important details traversed by the survey, refer to the sketches at the back of the field notes. Show the different vegetative covers by light lines and identify them by abbreviations in accordance with the standard conventional signs. Never use colored pencils on the plotting paper.

Place the title of the survey at a convenient space, preferably on the upper right hand corner of the plotting paper.

D-16, Forest Station \_\_\_\_\_ Index No. \_\_\_\_\_

Survey of \_\_\_\_\_

Located in So. \_\_\_\_\_, Bo. \_\_\_\_\_

Mun. \_\_\_\_\_, Prov. \_\_\_\_\_

Surveyed by \_\_\_\_\_ (Name & Title), \_\_\_\_\_ (Date)

Plotted by \_\_\_\_\_ (Name & Title), \_\_\_\_\_ (Date)

Traced by \_\_\_\_\_ (Name & Title), \_\_\_\_\_ (Date)

Instrument used: \_\_\_\_\_

Distances by: \_\_\_\_\_

No. of Kilometers surveyed: \_\_\_\_\_

Scale: \_\_\_\_\_

Area in Hectares: \_\_\_\_\_

Under "Legend" indicate the different vegetative covers and natural land marks or improvements shown in the sketch, in accordance with the standard conventional signs adopted by the Bureau of Forest Development.

### 2.3 Tracing the sketch

Use a tracing paper of the same size as the cross-section paper used in plotting. Trace the sketch exactly as plotted with all the details, except that the vegetative covers have now to be indicated by colored pencils in accordance with the standard conventional signs adopted by the Bureau of Forest Development as follows:

- Commercial Forest - green diagonal lines, approximately  $45^{\circ}$  from SW to NE;
- Non-Commercial Forest - blue diagonal lines, approximately  $45^{\circ}$  from NW to SE;
- Cultivated land - red vertical lines;
- Grass, cogon or open land - yellow horizontal lines;
- Non-commercial forest mixed with brushland or pure brushland - blue diagonal broken lines, approximately  $45^{\circ}$  from NW to SE
- Marsh or Swamp - green horizontal broken lines,
- Kaingin - red broken lines at random

If the survey is made in a reforestation project or on a forest station level, at least 3 copies of the tracing have to be prepared and submitted as follows: the original together with the field notes to the Central Office; one duplicate copy to the Regional Office and the District Office concerned. One copy is retained for the records of the project office or the forest station.

THE CLOSE TRAVERSE

If the survey made to delimit a tract of land ends at the same point where it started, the resultant survey line or loop produced is called a close traverse. A close traverse survey is made to determine the actual shape, size and extent of an area, as well as its relative location with respect to points or important land marks known in the map for various purposes.

3.1 The sketch with technical description

Aside from the sketch produced by tracing the plotting, a sketch with technical description has to be prepared for each close traverse survey. The technical description is a tabular statement consisting of the bearings and distances between corners, description of corners, as well as the bearings, distances and description of tie points. While the tracing of the sketch as plotted goes with the field notes, each copy of the report on the close traverse must be accompanied by a sketch with technical description. This sketch is the main basis of the report.

The following items must be considered in the sketch to show the relative location of the area:

- The nearest forest zone or land classification (L.C.) corners;
- Adjacent or nearby areas under forestry permits or leases, or at least some of their corners,
- In delicate cases, the ordinate and coordinate lines under which the area falls.

SKETCH SHOWING

The area under Ps. A. No. 116 of Mr. Alfonso Rodriguez

Located in:

- Sitio: Dagdagupan
- Barrio: Villacorta
- Municipality: Mabini
- Province: Pangasinan

Surveyed by: For. J. Mariano Date: Jan. 4-5, 1972

Plotted by: For. J. Mariano Date: Jan. 8, 1972

Compiled/Traced by: For. J. Mariano Date: Jan. 8-9, 1972

P.M.D. Used: Index No. 515, Mabini Reforestation Project, Mabini, Pangasinan

Scale: 1:10,000

Approx. Area: 19 Has.

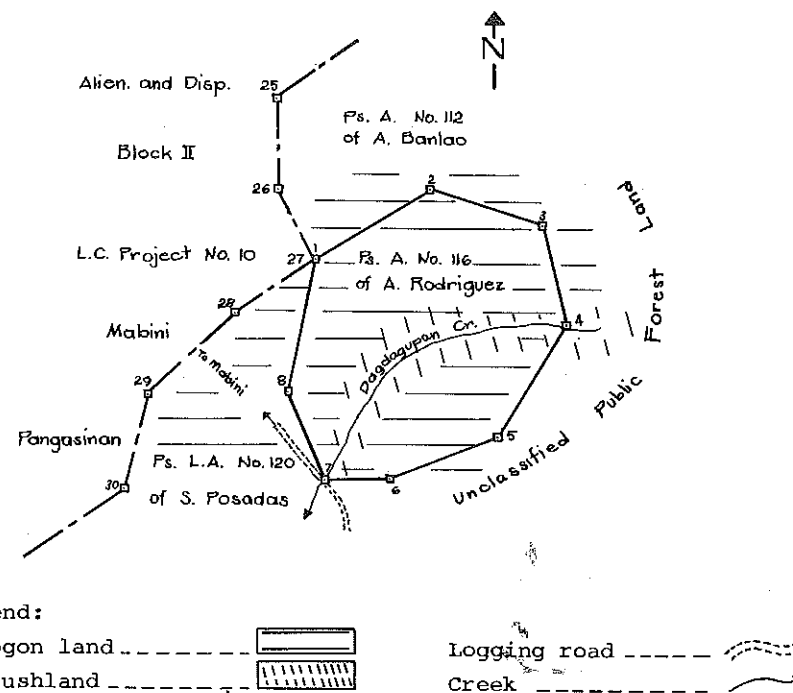

Fig. 7: Field Sketch (Technical description next page)

| LINE | BEARING & DIST.   | CORNER |       | DESCRIPTION of CORNERS                                             |
|------|-------------------|--------|-------|--------------------------------------------------------------------|
|      |                   | No.    | MARK  |                                                                    |
| 1-2  | N 55° E, 250 Ms.  | 1      | 515/1 | Molave, 30 cms., Cor. 27, A & D Blk. II L.C. Proj. 10 Mabini Pang. |
| 2-3  | S 75° E, 210 Ms.  | 2      | 515/2 | Akleng Parang, 20 cms., Cor. 8 Fs. A. No. 112 of A. Banlao         |
| 3-4  | S 10° E, 180 Ms.  | 3      | 515/3 | Dukat, 20 cms., Cor. 7, Fs. A. No. 112 of A. Banlao                |
| 4-5  | S. 32° W, 245 Ms. | 4      | 515/4 | Kalumpit, 40 cms., North bank of Creek                             |
| 5-6  | S. 70° W, 215 Ms. | 5      | 515/5 | Banayoyo, 25 cms., on foot of hill                                 |
| 6-7  | D- W 120 Ms.      | 6      | 515/6 | Palosapis, 50 cms., Cor. 10, Fs. L.A. No. 120 of S. Posadas        |
| 7-8  | N 22° W 175 Ms.   | 7      | 515/7 | Sakat, 35 cms., junction of Creek and logging road                 |
| 8-1  | N 11° E 250 Ms.   | 8      | 515/8 | Dita, 30 cms., Cor. 8 Fs. L.A. No. 120 of S. Posadas               |

Corner 1 is identical with corner 27, A & D Block II L.C. project No. 10 of Mabini, Pangasinan

Fig. 7 (continued): Technical description of survey.

Adjust the boundary of the sketch if the following conditions exist:

- If a portion of the close traverse falls inside an alienable and disposable block, or when in conflict with existing forestry permit or lease; and
- If the area happens to be close to an alienable and disposable block or to areas under forestry permit or lease, to avoid narrow strips or small patches of vacant areas.

The boundary can be adjusted simply by selecting common corners with the adjoining alienable and disposable block or areas covered by a permit or lease.

Indicate the details and legends in the same manner as in the tracing of the original plotting.

### 3.2 Correcting error of closure

When plotted, a close traverse seldom closes due to errors in taking the bearings and in measuring the distances between stations. The gap or difference in distance and direction produced after plotting the survey is called the error of closure.

Figure 8 below is the sketch of a proposed pasture area which did not close by a distance represented by x.

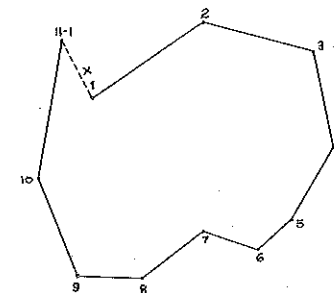

Fig. 8: A close traverse survey with error of closure

In correcting the error of closure, station 1 remains a fixed point because in a survey, there is normally no error of closure incurred at the point of beginning. The rest of the stations will have to be adjusted either forward or backward depending on whether the last station falls short of, or overshoots the first station when plotted. In the foregoing illustration, stations 2 to 11 will have to be moved backward. The error of closure in each station maybe determined either by the diagram method or by computation.

#### a) The Diagram Method

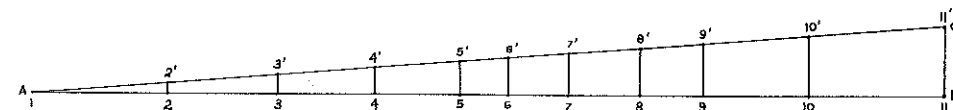

Fig. 9: The correction diagram

With the same scale used in plotting, draw a straight horizontal line AB, the length of which equals the total length of the traverse. Points A and B, therefore, correspond to stations 1 to 11, respectively. On this line, lay off stations 2 to 10, from point A at intervals equal to their respective distances as plotted. At point B, erect a perpendicular line



equal in length to the error of closure, X in Fig. 8. In the diagram this is line BC or 11-11'.

Then draw line AC. From points 2, 3, 4, 5, 6, 7, 8, 9, and 10, erect perpendicular lines up to line AC. These lines, e.g. 2-2', 3-3', etc., determine the distances at which the stations will have to be adjusted in order to close the traverse.

b) By computation

Multiply the error of closure by the distance of a particular station from station 1, then divide the product by the total length of the close traverse. The quotient equals the error of closure in such a station, or the distance at which it has to be adjusted.

Example: A close traverse has a total length of 2,500 meters. When plotted, it did not close by 50 meters. Compute for the error of closure in station 5, assuming the distance is 800 meters from station 1.

Solution:  $\frac{50 \text{ ms.} \times 800 \text{ ms.}}{2,500 \text{ ms.}} = 16 \text{ meters}$  - Error of closure in station 5

The process is repeated with the rest of the stations, except the first and the last stations.

c) Correction of plotted traverse:

The figure in solid line below is a reproduction of the traverse as plotted. From stations 2, 3, 4, 5, 6, 7, 8, 9, and 10, draw downward, light lines parallel to line X, the line representing the error of closure. Along these parallel lines, the stations are moved backward according to their respective correction distances as determined in the correction diagram or as computed. The adjusted stations, points 2', 3', etc. in the figure below, are then connected by a broken line which now represents the close traverse as corrected.

The corrected traverse is the basis in making the sketch with technical description. However, stations not considered as corners are omitted.

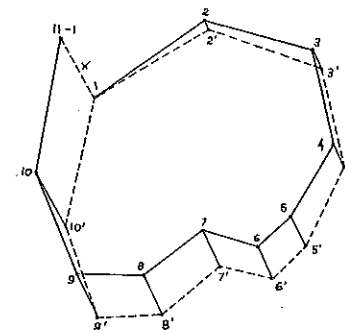

Fig. 10: Correcting the error of closure

3.3 Area determination of a close traverse.

- a) Planimeter method: A planimeter is a mathematical engineering instrument for the rapid determination of areas of plane surfaces. It consists mainly of three parts: a ploe arm, a tracer arm and a carriage which supports a vertical wheel equipped with a graduated scale and a vernier and a registering dial. It works by setting and adjusting the instrument besides the sketch and tracing the boundary of the traverse by the tracer point. The reading at the registering dial is multiplied by a constant conversion factor depending on the scale to obtain the area of the close traverse.
- b) Determination of area by computation: This method is convenient when the traverse has the shape of square, rectangle or triangle and the area can be computed with the help of the standard formulas. A polygonal traverse has to be subdivided into more simple geometrical forms to which the standard formulas can be applied.
- c) By counting the squares on cross-section paper: The field notes are plotted on standard size cross-section paper at a scale of 1:5,000 or 1:2,000 depending on the importance of details. If the scale is 1:5,000 and the size of the squares is 0.5 by 0.5 cm, 16 squares would make one hectare. Then portions of squares are estimated and their aggregate area is computed and added to the area of the whole squares to compute the entire area of the traverse. This method of area computation is most commonly used in forest surveys in the Philippines.

Appendix

Conventional abbreviations used in field sketches.

|                                                                      |                                             |
|----------------------------------------------------------------------|---------------------------------------------|
| TRIANGULATION POINT ----- Art.                                       | TREE FARM - LUMBANG<br>PLANTATION--Tf.-Lmp. |
| HOMESTEAD APPLICATION UNDER<br>PUBLIC LAND ACT----- H.A.             | TREE FARM - CITRUS<br>PLANTATION--Tf.-Ct.   |
| LEASE APPLICATION UNDER<br>PUBLIC LAND ACT----- L.A.                 | TREE FARM - MEDICINAL<br>PLANTATION--Tf.-Mp |
| SALE APPLICATION UNDER<br>PUBLIC LAND ACT----- S.A.                  | TREE FARM - RUBBER<br>PLANTATION--Tf.-Rp    |
| FREE PATENT APPLICATION---F.P.A.                                     | TREE FARM - CACAO<br>PLANTATION--Tf.-Cc     |
| FOREST CLAIM----- F.C.                                               | VEGETABLE GARDEN-----Vg.                    |
| PRIVATE WOODLAND REGISTRA-<br>TRATION APPLICATION---P.W.R.A.         | WOODLAND LEASE -----Wl.                     |
| PRIVATE WOODLAND<br>REGISTRATION----- P.W.R.                         | RESIDENCE -----Rs.                          |
| BATHING ESTABLISHMENT---- Be.                                        | SANATORIUM -----Sn.                         |
| COMMUNICATION STATION SITE-Cs.                                       | PRIVATE CAMP -----Pc.                       |
| COMM. SITE FOR RADIO,<br>WIRELESS OR TELEVISION<br>STA.----- Cs.-Rd. | TIMBER DEPOT -----Td.                       |
| COMM. SITE FOR<br>TELEPHONE STA.----- Cs.-Te                         | SAWMILL SITE -----Ss.                       |
| KAINGIN----- Kgn.                                                    | HOTEL SITE -----Hs.                         |
| LIME and CHARCOAL KILN-- Lck.                                        | SALT WORKS -----S.w.                        |
| LOG POND ----- Lp.                                                   | PASTURE -----Ps.                            |
| LOGGING CAMP SITE ----- Lc.                                          | NIPA-BACAUAN PLANTATION---Nb.               |
| LUMBER YARD ----- Ly.                                                | FISHPOND -----Fp.                           |
| RIGHT-OF-WAY----- Rw.                                                | LICENCES -----L.                            |
| TREE FARM----- Tf.                                                   | TIMBER LICENCE<br>AGREEMENT -----T.L.A.     |
| TREE FARM-COFFEE<br>PLANTATION---Tf.-Cp                              | ORDINARY TIMBER LICENCE-O.T.L.              |
|                                                                      | ORDINARY MINOR LICENCE--O.M.L               |
|                                                                      | COMMUNAL FOREST -----Cn.F.                  |
|                                                                      | COMMUNAL PASTURE -----Cn.Ps.                |

PART IV

NURSERY TECHNIQUES

G. SEEBER

Chapter 1:

NURSERY ESTABLISHMENT AND LAYOUT

1.1 Types of forest nurseries

According to the duration of their use, forest nurseries can be classified into two types: permanent nurseries and temporary nurseries (9).

- a) Permanent nurseries: A permanent nursery is established where a demand for a large number of plants is likely to continue for a number of years. The site should be accessible by road and centrally located within the reforestation area.

Permanent nurseries have several advantages. Because of their long lifespan it is possible to put up installations such as office building, storage shed, soil shed, watering system etc., which greatly increase the efficiency, but are not economical in a temporary nursery.

Since "the farmer's footsteps are the best manure for the farm", the daily inspection by the forester-in-charge will insure a high productivity of the nursery and good quality planting material.

- b) Temporary nurseries: The area of a temporary nursery is small, only a limited number of plants is raised for a certain plantation area. To avoid transport difficulties it is established near the planting site. After that particular area has been planted, the nursery will be abandoned.

The maintenance of a temporary nursery is relatively expensive. Failures are frequent due to inadequately trained workers and insufficient supervision. But, inspite of these disadvantages,

the establishment of a temporary nursery is advisable, where a relatively small area inaccessible by vehicles has to be reforested.

## 1.2 Selection of nursery site

The important factors to consider in the selection of a nursery site are: water supply, size and ownership of the area, location, accessibility, slope, site cover and soil condition (9).

- a) Water supply: The most important aspect in the selection of a forest nursery site is the availability of water throughout the year. The adequacy of water supply should be determined at the end of the dry season. It is often during this period that the water supply runs low and the nursery also consumes the greatest quantity of water (9).

The quantity of water required depends upon the size of the nursery, kind of soil, the species, the number of seedlings to be raised, and the irrigation method employed. Much water, for example, is needed in sandy soils, which have a low water holding capacity. Gmelina, molave, narra, teak, eucalypts, agohe consume less water than kaatoan bangkal, Moluccan sau, mahogany or dipterocarps. Flooding and furrow-irrigation (through earth canals) are possible only where there is ample water supply; overhead-irrigation (through pipes) consumes much less water.

- b) Size and ownership of the area: The nursery area should be wide enough to accommodate the seedbeds and transplant beds (potbeds), which are necessary to produce the required number of seedlings. In addition, there should be sufficient space to accommodate an office, greenhouse, nursery shed with soil compartments and similar facilities including an area for expansion.

The area needed for the nursery beds depends also on the species, which have different spacing requirements. Benguet pine seedlings, for example, need much less space than

eucalypts and other broadleaved species (See chapter on transplanting: "Spacing of Transplants").

In calculating the nursery area needed one has to take into account

- the annual plant production goal,
- the proper spacing of these plants in the transplant bed or potbed,
- the area needed for paths, roads, irrigation ditches and buildings plus some allowance for future expansion,
- the time the seedlings have to remain in the nursery, which may vary from 3 to 10 months, but hardly ever exceeds one year.

The nursery should always be located on land owned by the government, so that the forester-in-charge is free in his decisions concerning the layout and construction of buildings.

For temporary nurseries, however, it is also possible to rent an appropriate area for a certain period, e.g. rice lands in the immediate vicinity of the planting site. Rice fields would suit the purpose very well, because water is usually not a problem, the area is level and the soil conditions are favorable.

- c) Location: As much as possible a forest nursery should be centrally located within the planting area, so that the planting stock need not to be transported over long distances. Especially bare root seedlings suffer in long transit. Potted seedlings are better protected, but they are very bulky. Stumps are the easiest to transport, but only a few species can be grown from stumps. Where the road system is good it may be even possible to supply several reforestation projects from one large production nursery.

The nursery site should be protected from typhoons and parching winds during the dry season, but on the other hand must receive full sunlight. A low shelterbelt consisting of ipil-ipil or madre de cacao would in many cases be of great

help. The question, whether the nursery should have the same elevation as the plantation site is not important, as long as the species grows well on the selected area.

d) Accessibility: If the selected site is not located at a national highway or public road, it should at least be possible to construct a feeder road, where jeepneys and small size pick-ups can pass. Furthermore, arteries of roads or at least graded trails should radiate from the nursery to the plantation area to ease the transport of planting stock and as an aid in fire control (9).

e) Topography: The nursery site should be level. On level land all nursery operations are carried out more easily and economically, and it is possible to employ agricultural machinery and implements like tractors and plows.

On light sandy soil the site can be completely level, because surplus water will drain quickly into the soil. For average soil conditions (sandy loam, loam) a gentle slope of 1 to 2 percent is recommended to permit sufficient drainage.

But unfortunately, there is not always level land available for forest nurseries, since most reforestation projects are located in mountainous areas. Therefore, in many cases terraces have to be constructed, which is expensive and makes moving of materials and plants within the nursery laborious.

f) Ground cover: The kind of ground cover influences to a certain degree the cost of establishment. Often the area is covered with cogon, which has to be removed including the rhizoms as well as tree stumps and big stones. Where a bulldozer is available, second growth forest can be cleared at moderate cost, except the rhizomes and roots, which have to be removed by hand.

The vegetative cover is a good indicator of the fertility and average moisture conditions of a site.

g) Soil conditions: If only potted plants are to be produced the soil of the potbeds can be of rather low quality, because the roots will be confined to the potting soil inside the container. But there must be a place nearby, where good potting soil can be collected.

Where mainly bare root seedlings or stumps shall be raised, the soil should have favorable physical and chemical properties and contain a high proportion of organic matter. When a nursery site is chosen, the physical characteristics like friability, depth, soil structure and texture are more important aspects than the chemical composition of the soil. Chemical soil properties can be more easily corrected than the physical conditions of unsuitable soils like for example clays.

Most desirable are sandy loams or loamy sands, preferably with a high humus content and a pH value between 5.5 and 6.5. The greater the depth of uncompacted light soil, the better its drainage. Pure sand, stony soils or clay must be avoided.

### 1.3 Preparation and layout of the nursery area

a) Clearing of the land: If the existing vegetation consists of second growth forest, the procedure will be: cutting the trees, clearing the brushes, drying and burning the shrubs and herbs, or better, using the softer organic material for compost, removal of stumps, roots and big stones. When a bulldozer can be employed, the work can be accomplished much cheaper than with hand labor. If no machinery is available, a pulley-block should be used for pulling down the trees and uprooting them at the same time. Tall trees around the nursery site should be felled to avoid shading and damages during typhoons.

On grassland the procedure is similar: the grass is burnt during the dry season; roots and rhizoms are dug up and carefully removed by hand.

b) Soil working and layout of beds on level land: Clearing of the area is followed by digging the soil, breaking up lumps of earth, removing any remaining stones, and by raking to level the surface.

The soil can also be loosened by ploughing or by a rotary hoe. Ploughing should not be deeper than 30 cm to avoid burying the topsoil. To level the surface one can employ a harrow drawn by a horse or carabao. With a disc-plough loosening the soil and levelling the surface can be accomplished at the same time.

If mounds or depressions have to be levelled, first the topsoil is removed from the area and set up in heaps. It is replaced after the exposed subsoil has been levelled.

The shape of the nursery area can be square or rectangular. The first would minimize the length of the fence. For easier management, however, the rectangular shape is preferred because of longer working lines. But often there is no choice, and one has to comply with the topography.

After soil working and levelling the area is permanently divided by roads and crossroads or paths into blocks, which consist of a certain number of beds. When the nursery has the ideal shape of a rectangle, it will be of advantage to divide the nursery in longitudinal direction by a centre road wide enough for vehicles.

The main road is dug out 10 to 15 cm deep. The topsoil obtained hereby can be used to fill up uneven places on the adjoining land.

The size and layout of the blocks and beds depend on the kind of irrigation system to be installed. For overhead irrigation and watering by sprinkling cans, the beds should have a length of about 20 to 30 m (long working lines, favorable work economy) and a width of 1 meter. Where flooding or furrow irrigation is practiced, one has to construct main canal and head ditches. In this case the beds should not be longer than 10 meters to ensure equal distribution of the irrigation water.

After the layout the blocks are durably labeled by numbers painted on wooden posts.

Where small soil working machines are to be employed the crossroads should have almost the same level as the nursery beds, so that the area can be worked uninterruptedly without turning by simply lifting the machines when crossing.

But at present there are no nurseries in the Philippines large enough to justify full mechanization of sowing, transplanting, weeding and cultivation. Problems connected with the planning of such nurseries will therefore not be discussed. The minimum area required for a partly mechanized nursery, in which mainly soil working and irrigation is mechanized, is about one hectare. For full mechanization a minimum of about 10 hectares is required.

c) Nursery layout on sloping sites: Bench terraces, as known in the Philippines for the cultivation of rice and vegetables, cross the slopes in a series of earthen platforms following the contour (5). The terrace walls can be of earth covered with grasses, but better consist of dry stone walls (riprap), in exceptional cases of hollow blocks.

The width of the terrace platform depends on the gradient. The steeper the slope, the narrower the platform and the higher the terrace wall. The height of a riprap wall should not exceed 1.50 meters. Considering the width of the terrace, one also has to take into account the number of nursery beds and paths to be accommodated. It is advisable to draw a cross section of the proposed terrace in correct scale including the beds and paths. As much as possible, one should divide the slope better into a few wide than into many small terraces.

The terraces should be slightly sloping inward (about 1%), so that the run-off is collected in a shallow ditch along the base of the inside wall, from where the water is conducted into the main drainage canal.

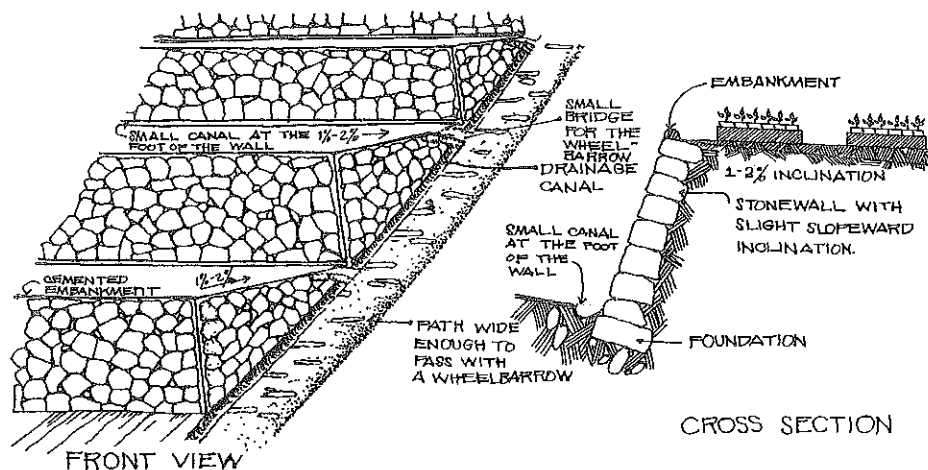

Fig. 1: Terraced nursery with dry stone walls

In constructing a terrace all topsoil should be saved. By no means should topsoil be covered with infertile subsoil. The first terrace is started at the foot of the slope using the topsoil of the second terrace for the beds. Upwards the work will proceed in the same manner (5).

As soon as the terrace is cut out of the slope, the steep part is immediately protected by a dry stone wall with a slight inclination towards the slope. The terrace will still grow in height by surface soil obtained from levelling the adjoining upper terrace. The top and corners of riprapped terrace walls should be solidified with cement.

Apart from the main road the terraces have to be connected by small paths suitable for wheelbarrows.

#### 1.4 Fencing the nursery site

Galvanized interlinked wire netting is well suited for permanent nurseries, because it is durable and gives good protection. The use of barbed wire should be avoided. Split bamboo or thorny branches of kamachile or aroma can be employed as fence material in temporary nurseries.

The fence posts should be of durable wood like teak, kamachile or molave, or made of concrete. Galvanized iron pipes set in concrete foundations are also useful. Length of the posts 2.20 to 2.50 meters.

Wooden posts must have a diameter of 10 to 15 cm and be impregnated with a wood preservative to increase their durability. Before treatment the posts are pointed. Treatment with wood preservatives is particularly important for the section in contact with the soil. The following three methods are recommended for fence posts:

- Brush treatment: After the bark has been peeled off, the posts are dried under the sun. This will cause many shrink splits on the wood surface. Then the posts are painted with the preservative by using a brush, or the preservative solution is applied with a sprayer. Painting the ground section of the post with coal tar is also a cheap and effective protection.
- Dip treatment: The posts are placed in a drum filled with a preservative solution (5-10%). They remain there for some time until the chemical has penetrated sufficiently into the wood.
- Osmose treatment: Timber with a high moisture content is treated with a water soluble preservative in paste form (e.g. Wolmanit salt). It penetrates into the wood gradually by molecular or ionic movement. This process is only possible with freshly cut posts. OSMOL powder is mixed with water until a paste is obtained, which is applied to the posts just after the bark has been removed. The treated posts are placed in a ditch, which is covered with cogon grass and sealed with earth to prevent drying and to keep the developing vapors within the ditch. After 4-8 weeks the osmose paste will have penetrated sufficiently, so that the posts can be taken out, dried and used.

The posts are placed 3-4 meters apart and driven 50 to 70 cm deep into the ground. Corner posts and other places of stress are braced. The wire netting has to be first tightened with a wire stretcher, before it is fixed with staples to the posts and with wooden pegs to the ground. Gates are constructed at convenient points.

Where desiccating winds prevail during the dry season, it is advisable to plant hedges around the nursery to reduce the wind velocity near the ground. Suitable species are ipil-ipil, madre de cacao, katurai, lantana, agoho. The hedges must be trimmed from time to time that they remain dense and look orderly.

#### 1.5 Buildings and similar facilities

The buildings should be constructed at the center of the nursery to facilitate supervision and reduce working and transport distances. This center should be accessible by cars and trucks with enough space that the vehicles can turn.

- Office, tool room: In most reforestation projects there is a main building with the office, the quarters for the forester-in-charge, and a guest room. This main building should also have a dry tool room, where all hand tools can be stored. Smaller tools are placed on shelves, the long-handled tools arranged neatly on special hangers or stands.
- Quarters: For better supervision and management it is desirable that the forester-in-charge resides within the nursery compound. For the same reason skilled appointed personnel, like plant propagators and nursery farm foreman, should have their homes near or at the nursery. Bunk houses are necessary, if the nursery is located far from any settlement.
- Storage room: Some kind of storage room provided with shelves and racks is necessary for all kinds of chemicals, fertilizers, cement, shading mats and their supports, wire netting, lumber, etc.
- Workshop: A small workshop is very useful for the repair of machinery, equipment and tools. On rainy days seed boxes and shading mats can be made here. The workshop should be furnished with a work bench, an anvil and a tool box equipped or carpentry, masonry, plumbing and mechanical work.

- Seed processing and storing facilities: Furthermore, facilities should be provided for drying and extracting seeds, such as a plain concrete floor in the open, or a wooden floor in an airy room, which can also serve as a storage room for seeds.
- Greenhouse: For raising delicate seedlings often a greenhouse is required. Its sides consist in the lower half of stone walls and in the upper half of wooden posts with mosquito screen in between. The roof is made of corrugated fiber glass sheets. Inside, there are concrete benches with side curbs about 20 cm high which are filled with soil.
- Garage or machine shed: For vehicles, tractors, ploughs, harrows and similar large implements a shelter has to be constructed to protect them from rain when not in use.
- Soil shed: In nurseries where potted seedlings are to be produced a soil shed with separate compartments for topsoil, sand, manure and compost is a necessary installation. Sufficient space must be provided that soil mixing and potting can be carried out under the shelter throughout the year.
- Compost compartments: One should not forget to provide a place to produce compost. Four to five compost compartments (1 x 1.5 x 4 m) made of hollow blocks with removal boards in front will make a practical compost plant (See "Preparation of compost").

#### 1.6 Tools and materials

A forest nursery must be equipped with all the tools, implements and materials required for the management of a nursery. It would be wrong to save money by not buying the tools needed. Not only the kind of equipment, but also the number and quantity of tools and materials should be adequate. There should be always some tools in reserve, which can be used immediately when the ones in use break down.

After use, tools and equipment should be well cleaned, dried, and stored in the tool room or in a shed. Metal parts must



be greased or oiled to protect them from rusting. From time to time a general inspection should take place, the dust and rust removed, hoes, bolos and axes sharpened, handles checked, and so on.

Apart from the common tools, a reforestation project should be provided with the following equipment:

- Ph-meter to test the acidity of the soil;
- Raingauge to keep rainfall data for the project area;
- Binoculars for judging the maturity of tree seed, for forest protection and supervision of the project;
- Ganta measure, set of measures 1000 cc., 500 cc., 250 cc., 50 cc., or a measuring glass;
- Balance with weight set.

## Chapter 2:

### INSTALLATION OF THE IRRIGATION SYSTEM

#### 2.1 Considerations about water quantity

The water requirements and the availability of water should already have been taken into account, when the site for the nursery was selected. If the water supply becomes critical towards the end of the dry season, it is recommended to install an overhead irrigation system by conducting the water

to the nursery through pipes and distribute it over the seedlings as a fine spray. Water losses and water consumption will be far less than in surface irrigation through open earth canals.

#### 2.2 Water sources

Possible water sources for a nursery are surface water, flowing as in a spring, creek or river, or standing as in a pond or lake. Or, irrigation water is obtained as ground water from a well.

- a) Surface water: The water level, particularly of surface water, is generally affected by the seasons. To increase the quantity of water at the nursery disposal at times of shortage, it is advisable to build a cement tank (about 2 x 2 x 1 m) around the spring or to construct a dam across the creek. The tank or dam is filled with water during times of low consumption, for instance during night time, so that there will be enough water for irrigation in the morning. If an intermittent creek is to <sup>be</sup> utilized as a water source, a storage dam or pond would solve the problem. Such a system of dams and ponds (fishponds), which are filled up during the rainy season, has been established at the Magat Reforestation Project.
- b) Ground water: Sometimes only little water is needed, because the nursery is small or the climatic conditions are favorable. In this case it might be cheaper to dig a well right in the nursery compound than to get the water from other possibly far-away sources.
- c) Wells: Only in exceptional cases all the irrigation water required for the nursery might be obtained from a deep well, which is a much more reliable water source than surface water, but it involves a considerable investment.

Self-made wells can be dug where the water table is not deeper than 6 meters. A sealed well is filled up with gravel and sand after the pipe has been placed in the ground

water, while the hand-driven well is installed by driving a pipe of 20 ft length into the ground until water is reached (34). Such wells can be established at low cost by nursery laborers.

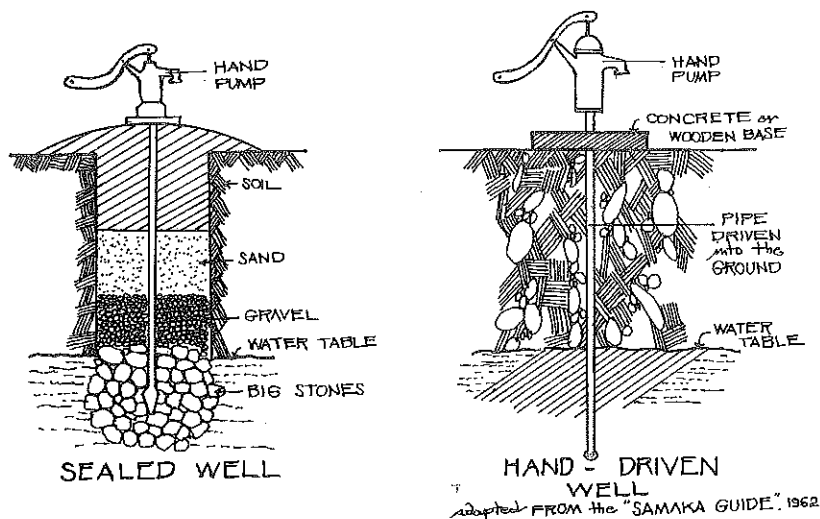

Fig. 2: Wells for a low ground water table

Sometimes it is possible to bore an artesian well. With this type of well no pump is needed because the water is forced out of the ground by natural pressure. The installation of an artesian well is only possible where special geological conditions prevail like in the plain of Oriental Mindoro.

- d) Level of the water source: In selecting the nursery site a higher level of the water source is desirable, because the water will flow to the nursery by gravity, provided the distance to the nursery is not too far and not too difficult to bridge. Such a system needs only little maintenance and will hardly cause operational trouble.

If the level of the water source is lower than the nursery, it can be either raised up to the point of diversion by

building a dam across the creek or river, or the water will have to be elevated with a pump, usually into reservoirs, from where it can be distributed over the nursery by gravity. It could also be pumped with small hand-pumps from shallow wells directly into sprinkling cans, or with turbine pumps immediately into oscillating or rotary sprinkler systems.

### 2.3 Types of pumps

The type of pump to be selected depends on the quantity of water needed, the pressure desired, and the depth of the water table. A simple hand piston pump is installed over self-dug wells. A centrifugal pump forces the water outward at a right angle to the axis. This kind of pump can be employed only where the suction is not more than 6 meters, which is also the limit for piston and rotary pumps.

Propeller pumps and turbine pumps are able to pump water from a deeper level. They are highly efficient, have a great capacity and develop all the pressure required for high pressure overhead sprinkling systems. Although their installation is expensive, in special cases it may pay to employ them.

Pumps usually have their own motor except those operated by wind mills. As there is generally no electricity in the reforestation nurseries, the engine can be of the gasoline or diesel type. Diesel engines are recommended for heavier units (40 HP or more). Useful are centrifugal or rotary pumps that can be attached to the power take-off shaft of small two-wheeled multi-purpose tractors, if such tractors are employed in the nursery.

A special kind of pump operated by the water power of a river or creek is the so-called waterbuck. Where water must be elevated from a creek to a higher located nursery, its installation is very practical (no engine, no fuel).

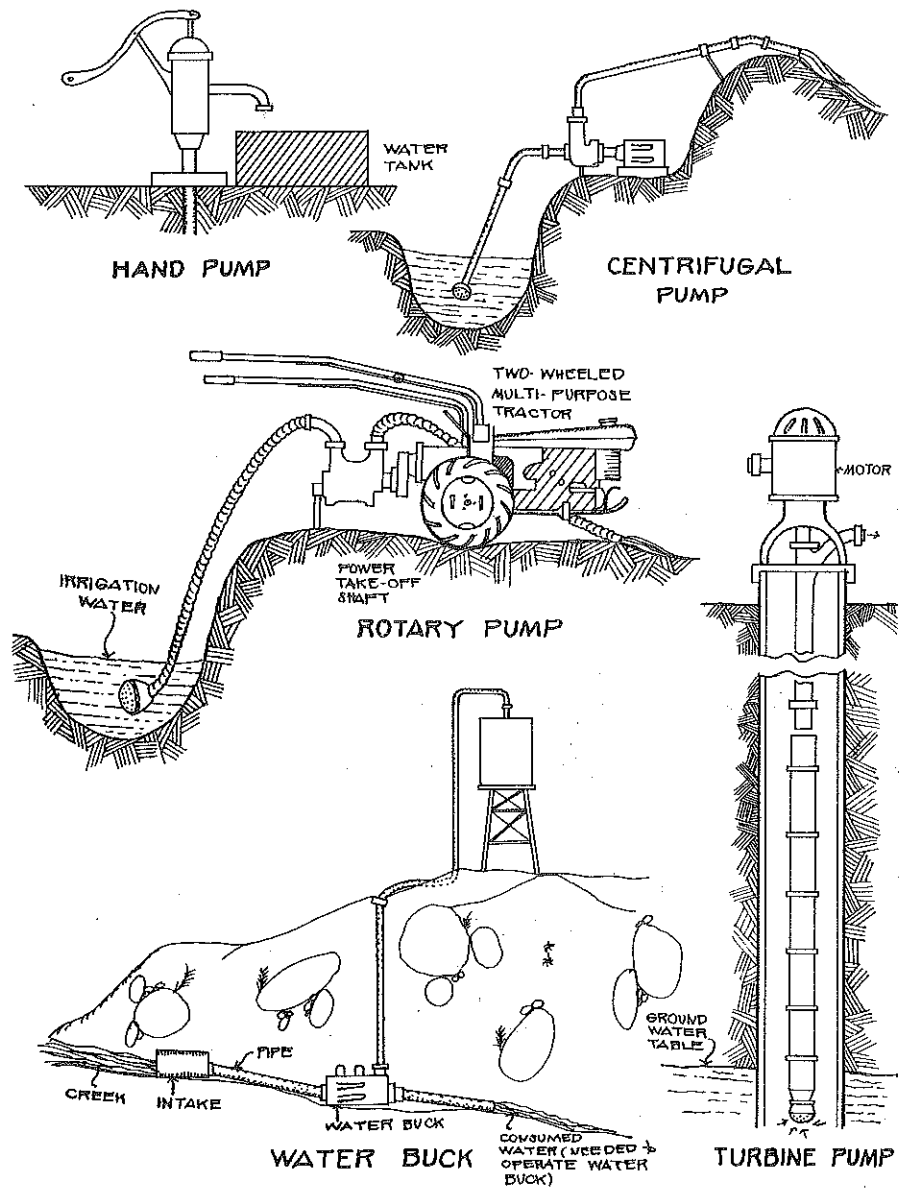

Fig. 3: Types of pumps for nurseries (partly adapted from "Irrigation and Drainage Principles and Practices" U.P. College of Agr., 1967)

2.4 Conveyance and distribution of irrigation water

Only in rare cases the irrigation water is obtained from a well within the nursery compound and pumped to an elevated water reservoir or directly to a high pressure overhead irrigation system. Usually the water source is located at some distance, from where the water is conveyed to the nursery and distributed over the land through channels or pipes by gravity.

a) Conveyance of irrigation water through canals: Conveyance channels are mostly simple earth canals, which are cheap and easy to construct. They can, however, only be recommended where ample water supply is available throughout the year, because much water is lost through seepage and evaporation. This system is used to water seedbeds and transplant beds by flooding or furrow irrigation. In the layout the following points have to be considered:

Very few earth materials will withstand water flow velocities greater than 5 feet per second (39). Therefore the gradient of the canals can only be slight. For steep gradients the water has to be conveyed through pipes.

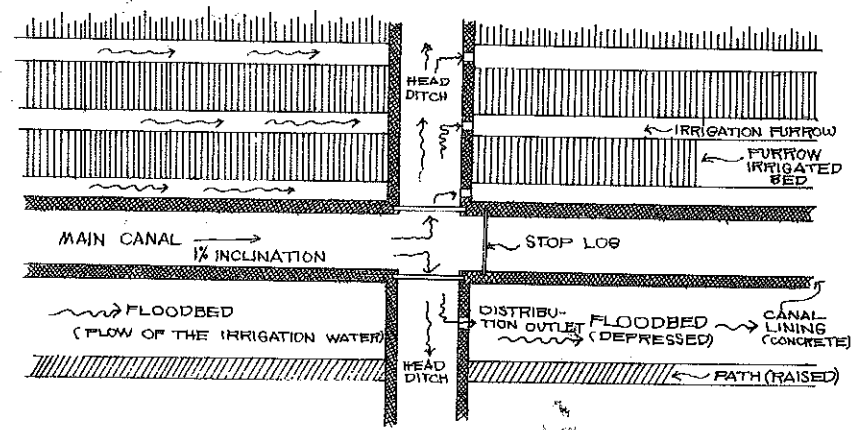

Fig. 4: Layout of flood irrigation

Excessive weed growth in and around the canals is undesirable. The canals might get clogged and weed seeds are carried into the nursery. Where the water reaches the nursery a strainer has to be installed and inspected and cleaned regularly. Sometimes "flumes" have to be built to conduct the water across depressions (39).

Within the nursery the water is channeled from the main canal into the head ditches, which run along the front sides of flood beds and furrow beds. The head ditches may be dug into the ground or made of wood, metal sheets or concrete with built-in distribution outlets for each floodbed or irrigation furrow. The latter, though more expensive, are far more satisfactory in the long run than earth ditches.

In earthen head ditches, the outlets can be simply closed with soil or mud. Better are short metal or bamboo tubes with metal checks inserted at each flood bed or furrow to be irrigated. Where the head ditch is higher than the irrigation furrow, the water can be made to flow by suction through a bent rubber hose with one end submerged into the water of the head ditch.

- b) Conveyance of the irrigation water through pipes: Where the water supply is limited, the water is usually conveyed and distributed through pipes to avoid seepage and transpiration losses. Also in a steep topography the use of pipes has obvious advantages over canals.

Potted seedlings are better watered by overhead irrigation (sprinkling) than by flooding, because with surface irrigation the roots tend to grow quickly out of the containers and penetrate into the soil. Even in nurseries where most of the beds are watered by flooding and furrow irrigation, some water faucets are additionally needed for greenhouse management and the tending of more delicate plants.

The main pipes should be at least 2 inches wide. For temporary nurseries bamboo pipes may be sufficient.

Hydrants with faucets are located at convenient points in the nursery. If possible, every part of the nursery should

be within reach of a 30-meter hose. The hydrants can be connected with perforated pipes, which transform the water into a spray. Such pipes are laid out on the ground or raised about 1 meter above. They can be installed permanently or designed as portable systems provided with quick coupling devices.

The kind of sprinkling system that can be employed depends on the operating pressure in the pipe. Low-pressure systems, such as spraying nozzles or perforated pipes, require at least 15 psi. Oscillating and rotary sprinklers are high-pressure systems; they can be operated only with a water pressure of 30 psi or more. The natural water pressure might be sufficient for the operation of a high-pressure overhead irrigation system, if the water source is located well above the nursery, and the main pipes have a diameter of not less than 2 inches. Otherwise, the necessary pressure would have to be developed artificially by pumps.

## Chapter 3

### SOWING

Sowing is one of the most important nursery operations. Its success or failure may decide, whether the nursery will be able to supply on time the required number of plants and whether the goal of the reforestation plan can be accomplished.

### 3.1 The correct sowing time

- a) Longevity of seed: If seeds can be safely stored, a sowing date should be chosen that will promise plants of optimum size at the beginning of the rainy season. Seed, that quickly loses its viability, must be sown immediately after collection. In this case, one does not have any choice with regard to the sowing time.
- b) Local climate: Sowing has generally to be timed in such a way, that seedlings are ready for planting in the field just at the beginning of the rainy season. For regions with a uniform rainfall no special timing of sowing is necessary.
- c) Time needed to grow plantable stock: To determine the correct month for sowing one has to take into account the time required to raise plantable seedlings. This varies with the species, the climatic conditions and the way the nursery is managed.

Each tree species has its own pre-germination period. Eucalypts and agohe germinate already after 4 days, Benguet pine and Albizzia appear after about 2 weeks, while teak or lumbang need 1 - 2 months unless germination is hastened. After germination and transplanting fast growing species like Albizzia falcata, Gmelina, kaatoan bangkal will be ready for planting after 3 - 4 months in the nursery, while others take much longer, like narra, mahogany or Benguet pine.

In raising potted plants one has to consider that the seedlings show a balanced top/root ratio at planting time. If seed is sown too early, the plants are likely to become top-heavy and have a low chance of survival in the field.

- d) Determination of correct sowing time: To determine the ideal sowing time one counts back from the beginning of the rainy season the number of months required to raise adequate planting stock. For example: In localities of climatic region I, Benguet pine seedlings are planted in June/July. Germination and time in seedbed takes about one month; 7 - 8

months are needed to let the seedlings grow up to a height of 15 to 20 cm, that is a total of 8-9 months. Assuming that the ideal planting time is June, sowing consequently has to be carried out in September/October (43).

Based on the particular climate sowing schedules for the locally important tree species should be prepared for each reforestation project.

- e) Phasing of sowing: With larger amounts of seed not all should be sown at once. Sowing should be phased over 6-8 weeks with one week intervals. This is particularly recommendable where seedlings have to be potted or transplanted. If all seed of a large seed lot is sown at once, one may have a hard time catching up with potting (43).

### 3.2 Preparation of seedbeds

- a) Soil working: After the nursery has been cleared of the previous crop of seedlings, the land is thoroughly worked by digging it with a spade or digging fork. Where the area is large and level a small tractor with soil working attachments or a carabao-drawn plough can be employed.

While turning the soil with a spade, lumps of soil are broken up, and stones, roots and rhizomes removed. As soon as a strip about 1-meter wide has been worked over, it is raked and leveled. Nobody should step on the loosened soil anymore.

- b) Soil conditions for sowing: If the soil in the seedbed does not meet the necessary requirements for sowing, it can be improved by screening and by adding sand and humus.

At the time of sowing, the soil of the seedbeds should be slightly moist or damp. By working it in this condition one can obtain a most favorable soil structure. During rainy season the soil in the open is usually too wet for sowing medium-sized or fine seeds. If such seed has to be sown during this period and no greenhouse is available, some kind of temporary shelter has to be erected over the seedbed. For larger seeds no shelter is needed.

c) Lining out seedbeds: The necessary equipment are planting lines and measuring sticks. Plastic strings fastened to 50 cm long wooden stakes would make good planting lines. Measuring sticks 1.40 m long with marks at 10 cm intervals are used to measure simultaneously the width of the bed and that of the adjoining path.

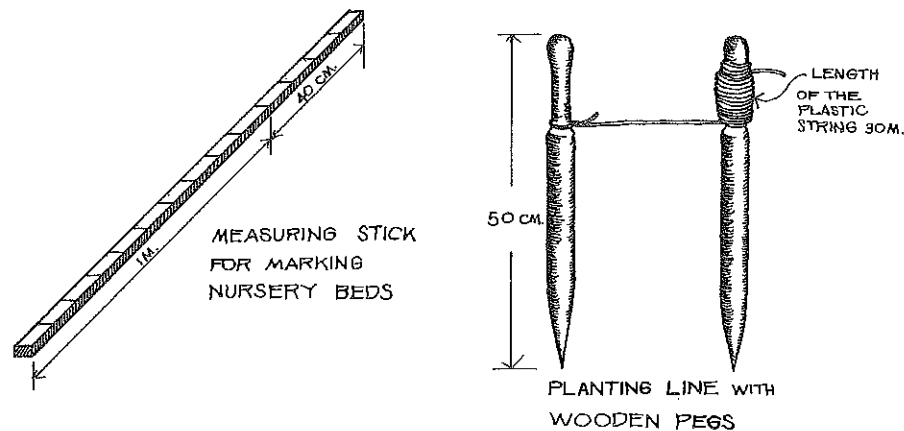

Fig. 5: Implements for lining out seedbeds

d) Layout of seedbeds for overhead watering: Their width is 1 m with a 40 cm path in between. For convenience of work the width of 1 m should not be exceeded. The bed surface should be level and only slightly elevated above the path (5-10 cm) with a low earth embankment along the margin of the bed to prevent the irrigation water from running off and washing away soil, seed or mulch.

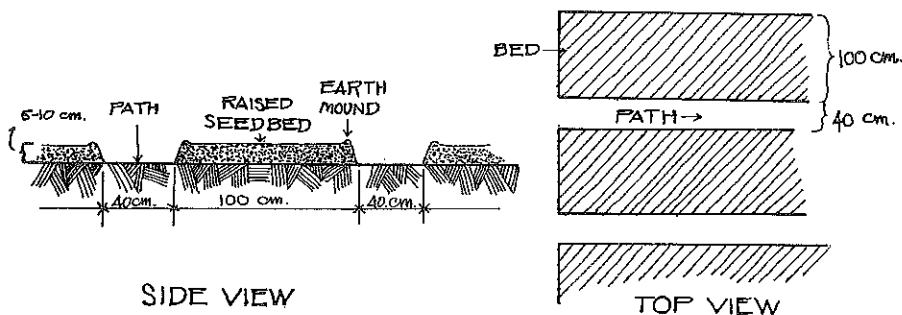

Fig. 6: Raised seedbed for overhead irrigation

This type of seedbed is suitable for fine and medium-sized seed, and is usually newly laid out after every cultivation period. The difference in level between the paths and the beds can usually be achieved by compacting the soil along the planting lines with the weight of the body. If this does not seem to be enough, some soil can be removed from the path with a shovel and placed on the adjoining beds.

The beds can be curbed on their sides to protect their borders. Useful for this purpose are wooden planks treated with a wood preservative and kept in place by pegs or curved iron bars. Instead of boards, also thick and straight bamboo poles are sometimes used. Because of their irregular shape the use of stones as curbing material is not advisable. The cracks in between provide a good anchoring ground for grasses with rhizomes and other weeds. Hollow blocks or solid concrete curbs are expensive, but durable. They also have the advantage that tight fitting protective plastic or mesh wire frames can be placed on top.

d) Layout of seedbeds for furrow irrigation: The width of these beds must be less than for overhead watering to facilitate water infiltration from the sides. Depending on the soil conditions the recommended width between furrows is only 40 to 60 cm. The furrows are 10 to 15 cm deep, and must not be wider than 30 cm, just wide enough to be used as a path when dry.

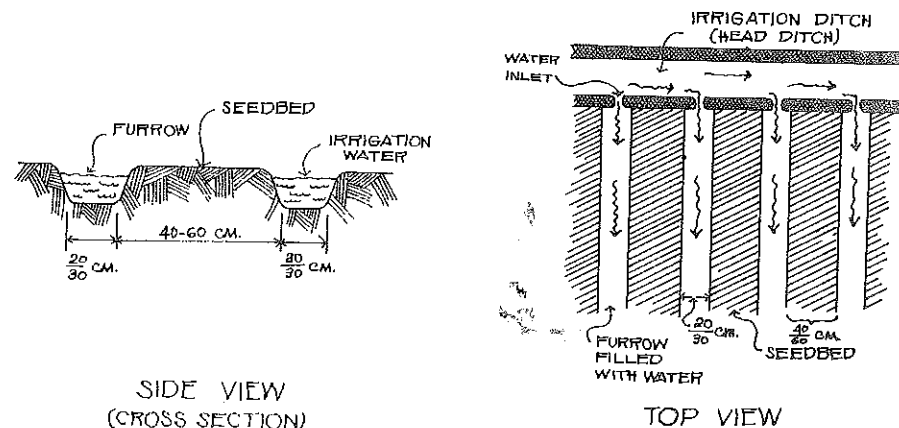

Fig. 7: Furrow irrigation

This type of seedbed has the advantage that the soil surface will not be disturbed by incoming water. This makes them suitable for the propagation of species with small seeds.

- e) Layout of floodbeds: They have the same dimensions as the seedbeds for overhead irrigation, but their cross section is directly reversed. The paths are elevated and the seedbed area is depressed. The surface must be level with a slight inclination from the water inlet towards the far end of the bed. The length of the bed should not exceed 10 meters to ensure an even distribution of water. Flood beds are only suited for species with larger seeds like teak, Gmelina, mahogany, narra, lumbang.

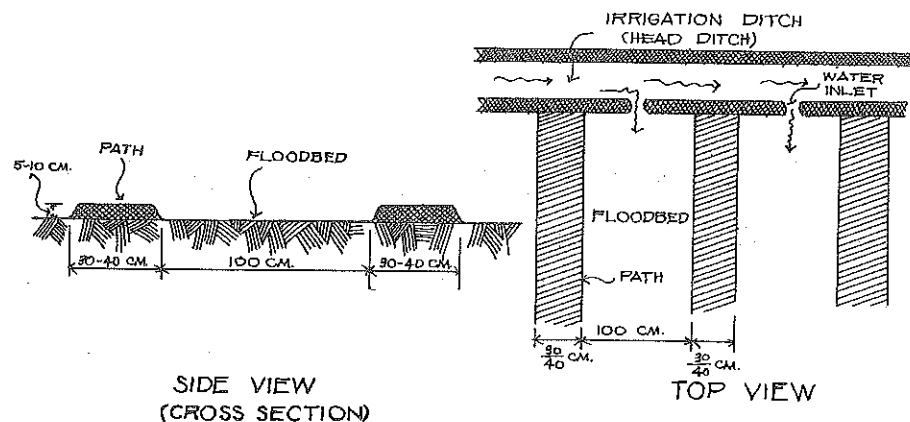

Fig. 8: Layout of floodbed

### 3.3 Preparation of seedboxes and greenhouse benches

Tree species with fine seeds, which after germination develop into delicate seedlings, should be propagated in seedboxes or greenhouse benches. It is much easier there to treat the soil successfully against nematodes and fungi, and to maintain favorable growth conditions than it would be in open seedbeds. Where greenhouse facilities are lacking, the seedboxes can be placed in the open on a bench under a

protective roof. The legs of this bench should be set in cans with water to prevent the seed or seedlings from being attacked by ants (34).

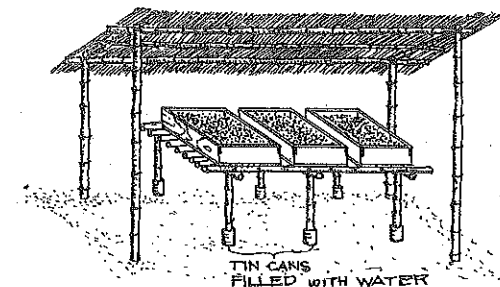

Fig. 9: Bamboo bench for seedboxes sheltered under cogon roof

- a) Construction of seedboxes: The convenient size of a seedbox can range from 30 x 35 cm to 35 x 40 cm with a depth of 10 to 13 cm. If it is larger, it becomes too heavy.

For the construction one takes 1-2 cm boards. The bottom must have plenty of drainage holes with a diameter of about 7 mm, so that water can enter when the box is placed in a basin, and excess water can drain off, but no soil would run through the openings. For greater durability the seedbox is treated with a wood preservative.

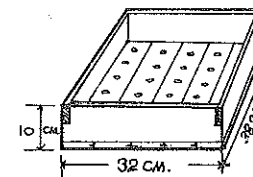

Fig. 10: Measurements of the seedboxes made at the Training Center in Baguio

- b) Preparation of soil mixture: Considering the usually fine nature of the seed a soil of similar fine texture has to be the basic component of the fill. Good topsoil with the characteristics of a sandy loam screened through a fine wire mesh would be a suitable material. To improve its properties one can add screened compost and sharp river sand.

For an average topsoil the recommendation is: 3 parts topsoil, 3 parts compost, 1 part river sand.

The soil mixture should be sterilized to eradicate whatever harmful organisms it might contain (fungi causing damping-off, nematodes, weed seeds). A self-made steam sterilizer, as described in Chapter 10 of this section, has been found effective and convenient for this purpose.

- c) Filling of seedboxes and greenhouse benches: Seedboxes and greenhouse benches to be filled must be clean and dry, and should have been sprayed with a fungicide (e.g. Agallol). While seedboxes do not need any drainage layer, greenhouse benches are filled with a bottom layer of small sharp stones, a medium layer of coarse sand, and a top layer of a sterilized soil mixture as shown in Fig. 11.

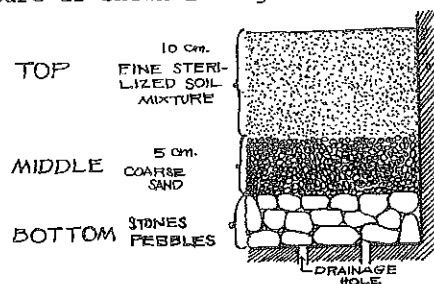

Fig. 11: Greenhouse bench with drainage layer

When placing them in the bench or box the soil materials are constantly levelled and slightly pressed down with a board or trowel to ensure equal settling. For the same reason seedboxes should be repeatedly lifted and dropped. The final surface level should be about 1 cm below the rim.

### 3.4 Sowing techniques

- a) Broadcast sowing: is employed for fine seeds like those of kaatoan bangkal (40), the eucalypts, bottlebrush, cypress, alder, agohe, African tulip, kalantas, banaba, Benguet pine. The advantage of broadcast sowing is a greater uniformity of the seedlings and a higher output per area as compared with drill sowing. However, the seed should not be broadcasted too thickly over the bed surface, so that the seedbeds will

not be overcrowded later and each seedling will be provided with adequate growing space.

If fine seeds are sown out of an envelope or so, they are likely to fall in clusters. A better way is to take one "pinch" of seed or seed/sand mixture between forefinger, thumb and middle finger. By holding the hand about 5-10 cm above the soil surface and rubbing the fingers slowly, the seed is allowed to escape little by little. The hand moves from one end of the seedbox to the other covering the area systematically. To achieve a correct and completely even distribution of fine seeds requires some experience (4).

For sowing kaatoan bangkal, the seed of which is brown like the soil, it is recommended to add some fine white sand as a filler to facilitate even distribution and to avoid too dense germination.

- b) Drill sowing: This is the general practice for sowing medium-sized or large seeds such as lumbang, teak, mahogany, narra, Gmelina, ipil, tindalo, akle. Benguet pine is also often sown in rows.

Sowing in drills allows root pruning, which is particularly important where plantable seedlings are raised without transplanting. Weeding and cultivation will be facilitated, because efficient weeding tools can be employed between the drills. Also lifting the seedlings will be more convenient. For all this kind of handwork the drills should extend crosswise over the bed surface. At last, the total number of seedlings in the nursery can be more easily estimated.

If the seeds are sown in drills, cultivation, root pruning and lifting can also be carried out by machines. Drill sowing is therefore the precondition for the complete mechanization of a forest nursery. In that case the drills run lengthwise, parallel to the paths.

Normally the distance between and within the drills is chosen according to the space requirements of the seedlings up to transplanting. Where the transplanting of seedlings before



field planting is not intended, as often practiced with teak, Gmelina and other species with large seed, the distances must be wider. There should be at least 20 cm room between the rows to allow the employment of the long-handled light weeding hoe. If after germination the seedlings turn out to grow too dense within the row, their stands should be thinned and the surplus seedlings transplanted.

The depth of the drills depends on the size of the seed and the condition of the soil. Large seed requires narrow but deep drills, while fine seed needs broad and shallow drills. The drills can be deeper in sandy than in heavy soils.

Suitable tools for placing the drills are drill marker, marking board and drill roller (33,37).

- Drill markers: can be employed for the large seeds of some broad-leaved species. Their teeth are 20 cm or more apart. Four or five drills are produced at a time by pulling the tool lengthwise or crosswise over the seedbed.

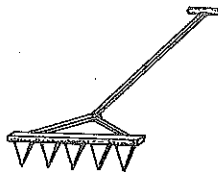

Fig. 12: Drill marker

- Marking boards: With them as well as with the drill rollers the drills are pressed instead of drawn, which is more favorable especially for smaller seed. All seeds will lie in an even horizontal line, and a close contact between seed and soil is established. Marking boards are made by nailing small slats with a rectangular or triangular cross section to the lower side of two parallel boards with handles. The implement is placed across the seedbed and the slats pressed into the soil. The depth of the rills depend on the pressure applied. Marking boards permit accurate and rapid work.

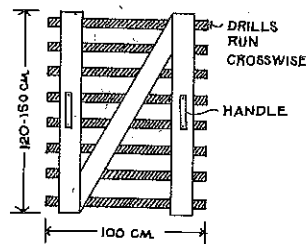

Fig. 13: Marking board

- Drill roller: It consists of a hardwood cylinder as long as the width of the bed (usually 1 m). When the rills shall run lengthwise, a number of slats (rattan) are nailed on its circumference and spaced at the desired drill distance. When the drill shall run across the seedbed, 1 m slats are nailed at the desired spacing around the roller. Drill rollers are very effective and permit rapid work. The roller should not be too light to exert adequate pressure on the soil surface.

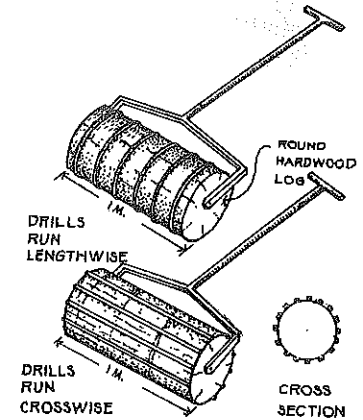

Fig. 14: Drill rollers

- In drills the seed is distributed by hand similar to the method described for broadcast sowing. So-called seeding troughs have been designed to facilitate an even distribution of finer seed. The various types are all alike in principle and consist of V-shaped troughs as long as the bed is wide. A measuring glass holding the quantity of seed for a single drill is used to fill the trough, in which the seed is evenly distributed by hand. With one kind of seeding trough the bottom can be opened to release the seeds into the drills, others have to be turned.

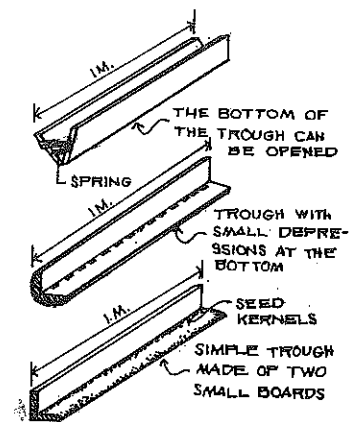

Fig. 15: Seeding troughs

Large seeds are placed individually into the loose and friable soil. There may be no need to make drills. Mahogany is placed on edge with the wings all pointing in the same direction. The usual practice with dipterocarps, which have large wings compared to the size of the nut, is to push the nut into the soil

at an angle, until it is just below the surface. Large seed should be sown in a position, it would also assume in nature (4).

- c) Sowing directly into pots: The purpose is to save transplanting costs. This method can be practiced only with seed of high germination capacity and is quite common in raising Benguet pine. The containers are filled with soil and the seed is sown with the help of a dibble.

With seed of 75% germination or better only one seed per pot is sown. After 3 weeks the blanks are resown. If the germination percent is between 50 and 75 one should sow two seeds per pot. If more than one seed germinates, one can be pulled out and planted to a blank pot. If the germination percent is below 50% pot seeding is not recommended (43).

A better way of pot sowing for Benguet pine would be to sow only the viable seeds, one in each pot. The viable seeds can be distinguished from the rest by soaking the seeds for 24 hours in water. After that time they will swell and start germinating.

- d) Covering after sowing: Broadcasted seed in seed boxes or greenhouse benches is covered with a thin layer (1-3 mm) of a sterilized sand/humus/soil mixture. By placing the soil in a small hand screen with a fine mesh and rubbing it carefully with the fingers one can achieve a fine and even covering of the seeds. The cover is slightly tamped with a small tamping board to establish good contact between seed and soil.

For seedbeds in the open, basically the same procedure is adopted. The depth of the cover should be more or less the same as the diameter of the seed or range from one to two times its smallest diameter. The soil used for covering should be loose, friable and of fine texture. Pure sand is recommended for pine seed to prevent damping off. In this case a light shade is necessary to avoid overheating (43). In broadcast seeding the soil cover is screened over the seedbed with a large screen with a 5 mm mesh. The sieve should have the same length

as the width of the bed. It is handled by two men, while a third fills in the covering material. Afterwards the seedbed is rolled (37).

Seed sown in drills is covered by hand with a good soil mixture or with the soil of the seedbed itself, which is then lightly tamped with a roller or a rake.

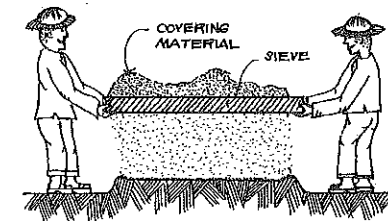

Fig. 16: Covering of seedbed

- e) Mulching: This is an excellent measure in open seedbeds to keep the seeds constantly moist during germination and to protect soil and seed from the hazards of heavy downpours. For more details see "Care and Maintenance of Seedlings, Mulching".
- f) Watering: Greenhouse benches are watered with a backsprayer or a small sprinkling can with a flat rose in horizontal position throwing a fine spray upwards, which falls gently on the soil surface.

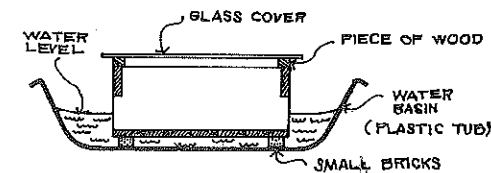

Fig. 17: Watering of seedboxes

Seedboxes are submerged with their lower part in a flat basin. The water enters through the joints and drainage holes and rises to the surface by capillary action. Since the soil in-

side the seedbox becomes saturated with moisture, watering may be necessary only once or twice a week. Only clear rainwater or tap water directly from a well or spring is used to avoid infestation of the sterilized soil with fungi causing damping off.

#### Chapter 4:

#### PRODUCTION OF NURSERY PLANTS BY CUTTINGS

Apart from sowing, nursery plants can also be propagated by asexual methods like layering, marcotting or cuttings. While layering is applicable only for low branching shrubs and marcotting is a time consuming technique carried out on standing fruit trees and ornamentals, propagation by cuttings is a possible way of plant production also in a forest nursery.

Cuttings are sections of roots, stems, branches or twigs gathered from suitable mother trees or shrubs. They are placed with part of their length into a suitable rooting medium to induce the formation of roots at the basal end and the development of buds and leaves on the upper portion. A cutting will thus grow into a new individual plant.

However, although simple and suited to the propagation of tree species, exclusive propagation by cuttings cannot be recommended for large-scale reforestation programmes, because the production cost per plant is relatively high, the

rooted cuttings are often less robust than seedlings, and it may be difficult to secure enough branch wood to prepare cuttings in sufficient quantity.

On the other hand, since asexual propagation methods ensure, that the offspring will possess exactly the same genetical characteristics as the parent plant, propagation by cuttings is nevertheless employed in all cases, where a specific genotype shall be preserved like in tree improvement programs or in the propagation of ornamentals and fruit trees with certain desirable traits. There are also some species which are very difficult to propagate by seeds, but grow easily from cuttings.

#### 4.1 Suitable species

Species that can be easily propagated from cuttings include paper mulberry (17), mulberry, *Gmelina arborea*, African tulip, kakawati, ipil-ipil, *Cryptomeria japonica*, as well as many ornamentals like *Hibiscus*, *Euphorbia*, *Cordyline*, *Lantana*, *Bougainvillea*, *Plumeria*, *Cestrum*, *Calliandra*, *Nerium* and many others.

#### 4.2 Propagation beds

A propagation bed for cuttings has to provide excellent environmental conditions that are not only favorable for the formation of new roots, but also for all the other life processes within the newly developing plant. These environmental factors are proper aeration (oxygen supply), adequate moisture content of the rooting medium as well as a high relative humidity of the atmosphere, good light conditions and a favorable air temperature (not higher than 27°C).

A bed for cuttings can be established in the open. It should be framed on all four sides with durable boards or concrete. The width should not be more than 1 m. For the more difficult species a greenhouse is to be preferred.

The rooting medium should be of light, loose nature with plenty of pore spaces to allow good aeration and to drain

off excess water. It is essential that the rooting zone is well supplied with oxygen, and yet has a certain water holding capacity. The rooting medium should also contain the basic plant nutrients, especially nitrogen.

For the majority of species coarse sharp river sand mixed with sterilized old compost at a ratio of 2:1 or 1:1 would make a good medium. Species that root easily can be simply set in loamy sand. Clean sharp river sand, which has been freed from organic matter and soil by washing, is a good medium for conifers.

A high relative humidity around the cutting is necessary to reduce transpiration to a minimum, especially with hard-to-root species which have retained their leaves. The humidity can be maintained by covering the propagation bed with a fitting plastic frame. Propagation beds with a plastic cover need to be moderately shaded to avoid overheating.

By installing an automatic intermittent misting system one can keep the humidity permanently high without needing a protective cover. By cooling the leaf surface transpiration will be further reduced, so the cuttings can be exposed to direct sunlight. This has the advantage that the leaves can fully assimilate, which has a stimulating effect on root formation. The installation of such a misting system, however, is quite expensive and only possible where there is electric current.

#### 4.3 Sources of cuttings

Cuttings are best obtained from young vigorous mother trees. The younger the mother plant, the faster the formation of new roots (15).

The quick appearance of the adventitious roots depends to a large degree on the quantity of carbohydrates stored in the tissues of the cuttings. Lateral shoots and side branches contain more starch than terminal shoots, more of it is found at the base of a branch than at its tip. Little carbohydrates are generally accumulated in a succulent shoot being in a stage of rapid growth (15).

For broadleaved species the best cutting material are therefore the young, but sufficiently matured and lignified side branches with a diameter ranging usually from 5 to 10 mm.

The branches are removed from the parent tree with pruning shears or a pruning saw with a clear sharp cut, and divided further into handy pieces. To prevent fungus infection of the mother tree the wound can be treated with grafting wax (4 parts resin, 2 parts beeswax and one part of tallow mixed and melted in a metal container) (9).

Broadleaved species that grow easily from cuttings are stripped of their leaves to reduce transpiration losses. Species that can only be rooted with difficulties must keep their leaves, because the assimilates and growth hormones produced in there will have a stimulating effect on root formation.

Cuttings from narrow-leaved evergreen conifer species like *Chamaecyparis*, *Thuja*, *Juniperus*, *Cupressus*, *Cryptomeria* are either taken as terminal shoots with a small section of older wood at their base or as side twigs torn from the stem retaining a small slice of fully matured wood from the stem, a so-called "heel". A short cut below the branch would ensure, that the mother tree is not damaged too much. With the exception of *Cryptomeria* all these species are difficult to root.

Great care has to be taken, that the cutting material will not lose its freshness and dry out, which can easily happen with leafy cuttings. During transport they are therefore bundled and covered with wet newspaper or sacks. The cuttings should be prepared and planted on the same day.

#### 4.4 Preparation of cuttings

From the collected branchwood, cuttings are prepared by crosscutting it into sections of 15 to 20 cm. Large leaves of leafy cuttings are somewhat reduced in their size in order to economize in spacing.

It has been found out by experience that the presence of leaf buds induce rooting, while flower buds have a retarding effect. To stimulate rooting flower buds should therefore be removed(15).

The cuttings are then bundled again and placed upright with about half their length in water to keep them fresh until they are planted.

#### 4.5 Treatments to promote root formation

- Wounding: The formation of roots at the basal end of the cutting can be stimulated by wounding the lower 2 cm on opposite sides, either by cutting vertically through the cambium or by slicing off strips of bark with some adhering wood.
- Rooting hormones: They induce the cuttings to root earlier and to produce more roots. The more common active ingredients of these chemicals are indolebutyric acid and alpha-naphthalene-acetic acid. The marketed products are either formulated as powder (Rootone, Hormodin, Seradix, Wurzelfix) or as liquid (Shell A.N.A.A.).

Rooting hormone in powder form is applied by moistening the lower part of the cuttings and dipping them into the powder. Excess powder is carefully shaken off. The liquid formulations are diluted in water as prescribed by the manufacturer and the cuttings placed into the solution 12-24 hours before planting.

- Plant nutrients: HARTMANN and KESTER (1968) observed that rooting will also be promoted, when the rooting medium contains organic and inorganic nitrogenous compounds and boron.
- Fungicides: It is also believed, that fungicides like Ferbam or Captan (Orthocide 50) do not prevent only fungus infections, but also have a certain stimulating effect on root development.

#### 4.6 Planting of cuttings

After the rooting medium has been moistened the cuttings are planted either vertically or in slanting position covering

about 3/4 of their length. Care must be taken that they are not planted upside down. In that case they would not root. After planting the soil is slightly tamped and watered.

#### 4.7 Care of cuttings during the rooting process

Delicate cuttings are placed under a plastic frame cover. Several times a day the bed is sprayed or sprinkled with a fine rose. On sunny days the propagation bed with the plastic cover must be shaded (50 to 70% shade) to avoid overheating, and the plastic cover must be lifted a little to allow aeration.

After two to four weeks leafy cuttings will produce new shoots, or buds will appear on the bark surface of bare cuttings. At the same time callus will develop at the basal end of the cutting, which is an irregular mass of cells in various stages of lignification. Although, frequently, the first roots appear through the callus, root and callus formation are independent processes, which usually take place at the same time (15).

Where only sand was used as a rooting medium, most cuttings at this stage will benefit from a liquid application of a complete fertilizer. Plastic cover and shade are gradually removed as well as the intervals between the waterings and sprayings lengthened to harden the growing plant.

The care of the developing cuttings has to adjust to the constant change of weather conditions. With easy rooting species propagation by cuttings may be successful even without a plastic cover and without so much care, especially during the rainy season.

#### 4.8 Potting of the young offspring plant

The cuttings are ready for potting when the roots have reached a length of about 3-5 cm. The plants must be handled with great care, because the roots are quite brittle and easily break off. After transplanting they are treated like ordinary seedlings. Where required multiple leaders are cut leaving the strongest shoot.

TRANSPLANTING IN OPEN BEDS

Transplanting is the transfer of seedlings from seedboxes, greenhouse beds or open seedbeds to transplant beds or containers in order to provide each seedling with adequate space to grow and develop (9).

5.1 Preparation of seedlings

Seedlings are ready for transplanting when the first side roots appear and the stem tissues have hardened. At that time the seedlings have a height of 2-5 cm above-ground with a root 5-10 cm long.

Seedlings to be transplanted should be fresh and turgid, i.e. their vessels filled with water. This is achieved by watering them well the day before they are taken out from the seedbed. However, the time the seedlings are lifted, the soil should be only moist, not wet.

In lifting the seedlings from the seedbed one must be careful not to damage their shoots or roots. They should be rather "eased" out of the soil than pulled up. A pointed stick or a trowel are useful tools for this purpose.

If the taproots or side roots are already too long, they should be pruned with a knife or pruning shears. Very long and soft roots can be shortened by clipping them off with the fingernails just before transplanting. Only as many seedlings as can be planted within one hour or so are lifted and root-pruned at a time to avoid their drying out.

A suitable bunch of prepared seedlings is placed into a flat tin lined with moist soil, sack cloth or moss, thereby covering their roots with the same moisture holding material. All the time between lifting and transplanting, the roots must be constantly kept moist. If on a hot, clear, windy day the roots are exposed for even only 3 minutes, they will dry up becoming unable to supply the seedling any more with water and nutrients. Neither should the seedling be "mud-puddled" or filled in containers filled with water, as this washes the fine soil particles away and lumps the roots together. Soil that naturally adheres to the hair rootlets facilitates a better establishment of the seedling in the new soil of the transplant bed or pot.

5.2 Transplanting tools and techniques

- a) Transplant beds: are prepared for the production of bare-root seedlings and stumps. After the nursery area has been thoroughly worked, the transplant beds are laid out as described for seedbeds according to the irrigation method practiced. More often than seedbeds, transplant beds are laid out as floodbeds.
- b) Spacing of transplants: The seedlings should be set as wide apart as to provide sufficient growing space up to the time of field planting. This depends on the growth rate and the light requirements of the species and the kind of planting material to be raised (bare-root plants or stumps). Light demanders as pines, agoho or eucalypts need wider spaces than shade tolerant species as mahogany. The distance between the rows, however, should not be less than 20 cm, so that a light weeding hoe can be employed. Within the row, the seedling are placed usually between 5 cm (narra) and 20 cm (teak) apart.

The implements usually employed to obtain equal spacing of seedlings and straight rows are transplanting lines and transplant boards. Transplanting lines have knots or iron balls as space markings usually at 10 cm intervals and should be equipped with an attached winding-up apparatus. They either consist of nylon or stranded galvanized wire.

A transplant board is as long as the width of the bed and as broad as the desired distance between the rows. It is used where the rows run across the transplant bed. The distance between the seedlings is indicated by notches.

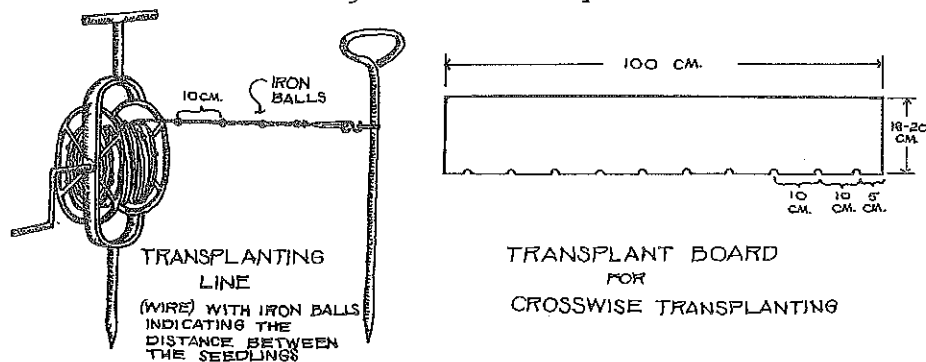

Fig. 18: Transplanting line and transplant board

c) Transplanting methods: In transplanting we can distinguish the dibble method, where a separate hole is produced for each plant, and the trench or furrow method.

The seedlings should be placed in the transplant bed in a natural upright position, the same way they have been growing in the seedbed. The roots too have to regain their natural position without being bent or twisted. It is advisable to plant the seedlings slightly deeper than they have grown before to allow the soil to settle.

d) Dibble transplanting: The dagger-shaped dibble is usually made of wood and about 10-30 cm long. Its cross section may be round or triangular with a diameter that can range from 1 to 4 cm depending on the size of the seedlings. It is mainly used for transplanting smaller seedlings.

The hole is produced by pushing the dibble vertically into the soil and prying it back and forth. When the transplant is inserted with the left hand in proper position, the hole is closed by thrusting the dibble again into the soil near the seedling pushing the soil into the opening. The soil around the seedling is then levelled and firmed with the hands.

Big seedlings that already have a root system too large for the relatively small dibble hole are transplanted with a trowel. With the right hand the trowel is driven vertically into the soil and pulled towards the operator. The seedling is inserted behind the trowel as deep as the roots will reach and then raised a little to straighten them. Now the trowel is withdrawn, and the soil filled back into the opening, compacted and levelled with the knuckles and fingertips of both hands.

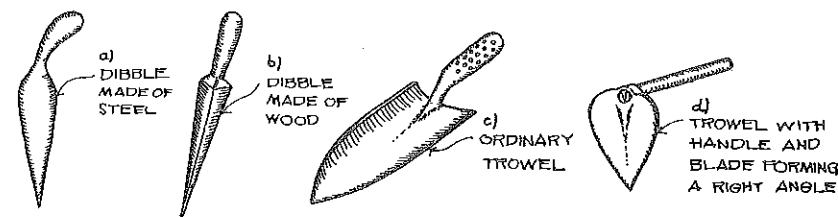

Fig. 19: Tools for hole (dibble) transplanting

There is also a handy transplant "hoe" (Fig. 19 d) operated in a way similar to the slit planting technique described in Section 2, Chapter 10 of this book.

e) Trench or furrow transplanting: Transplanting in trenches is less expensive than dibble planting where the soil is loose and a narrow spacing within the rows is adopted. The trenches, which can run lengthwise or crosswise over the bed, are made with trenching spades or hoes.

When the rows shall run lengthwise, the trench is opened along a transplanting line by two laborers starting from both ends of the row and working towards the middle of the transplant bed. Hereby the men step on walking boards to avoid compacting the soil. When crosswise trenches are to be opened, the 2 laborers stand on the adjoining paths and work along a transplant board towards the centre.

- Using a trenching spade: The trenching spade, which consists of a plain steel blade or of a wooden blade covered with iron sheet, is used by thrusting it vertically

into the soil and moving it back and forth to open up a trench about 6 cm wide. The next thrust is made aside to the previous one to produce a continuous trench. The planter immediately follows the trench maker by setting the plants at the marked intervals of the planting line. The trench is closed by filling the soil back by hand and firming it carefully around the seedling. The trenching spade can only be used on loose, sandy soil entirely free from roots and stones. In heavier soil it becomes difficult to force this tool into the ground, and the walls inside the trench become so compacted, that it will be hard to crumble the soil when the furrow is closed. This method is especially suited for smaller seedlings (33).

- Using a transplant hoe: In loamy soil the furrow is made with a broad-bladed hoe. It is thrust into the soil along a transplant line or transplant board and pulled towards the laborer forming a small wall of earth in front of him.

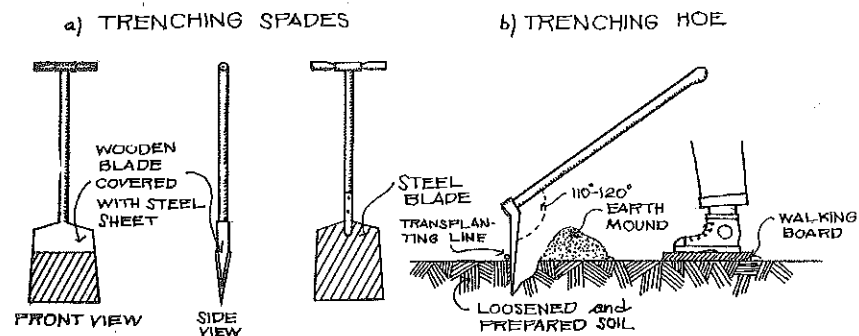

Fig. 20: Tools for trench (furrow) transplanting

The side of the furrow just along the planting line or board should be as vertical as possible to ensure an upright position of the transplant. For that reason the handle of the transplant hoe is attached at an angle of  $110 - 120^\circ$ . The plants are set at the desired intervals and the soil is filled back by hand and firmed down. Because of the deeper trenches that can be produced with the hoe this method allows transplanting of larger seedlings (33).

- f) Care of the transplant beds: After transplanting the beds have to be watered and shaded. The shade can be removed as soon as the seedlings resume growth. Repeated cultivation with a light weeding hoe or mulching would reduce soil evaporation and keep the bed surface in desirable condition.

Chapter 6:

### RAISING OF CONTAINER PLANTS (POTTING)

For better survival many reforestation species and ornamentals are raised in a container with an earth ball surrounding their roots. The advantage is that in field planting the root system is hardly disturbed and survival and growth especially on difficult sites is better than with bareroot seedlings.

However, the production costs for potted seedlings are much higher than for bareroot plants. The forester-in-charge has to investigate carefully, what kind of planting material is actually required in his particular project. It would be a waste of funds to raise potted seedlings, where bare-root plants can be set out with the same success.

#### 6.1 Types of containers

There are various types of containers in use for raising potted seedlings. The type to be selected depends mainly on the



availability and the cost. The dimension and material determines the weight and the quantity of soil at the disposal of the plants. For mass production one should use containers holding not more than 500 cc, larger containers are recommended only for ornamental plants and for special purposes. The appropriate size of the pot must be chosen according to the desired final size of the planting material to be produced. All containers should have drainage holes to allow the excess water to drain off.

Pots most commonly used in Philippine nurseries are plastic bags, boho pots and tin cans. Veneer pots are produced where waste veneer can be obtained from a local veneer plant.

a) Plastic (polyethylene) bags: have several advantages and can be ordered in suitable sizes. The most common dimensions are given below together with the approximate amount of soil they can hold:

- 3" layflat x 6" long 250 cc (generally too small)
- 4" layflat x 6" long 500 cc (very useful size)
- 6" layflat x 6" long 1000 cc
- 6" layflat x 8" long 1300 cc } for ornamentals
- 5½" layflat x 9" long 1300 cc } or fast growing  
broadleaved species

Plastic bags are relatively cheap, provided large quantities are ordered. They are light and can easily be carried to nurseries that are accessible only by foot trail.

Depending on their size plastic bags should have 12 to 24 drainage holes, which are usually punched with an ordinary office puncher or with a hollow chisel. It is not advisable to pierce the holes with a pointed stick or nail. When placing a large order the manufacturing firm should be requested to deliver the bags prepunched.

The plastic material must be sufficiently strong with a gauge not less than .002. Very thin material often does not last until field planting and becomes brittle through sun and rain

A possible disadvantage of plastic containers is that they cannot be bundled for easy transportation as boho pots, nor can they stand by themselves on a level surface.

b) Boho pots: The containers are prepared by cutting the poles into sections of about 15 to 20 cm. The inner diameter of the poles should be at least 4 cm. Cutting the bamboo poles into short pieces can be facilitated by placing them on a sawbuck. While one hand holds a measure, which indicates the length of the boho pot, the pieces are cut off with a bow saw with fine teeth.

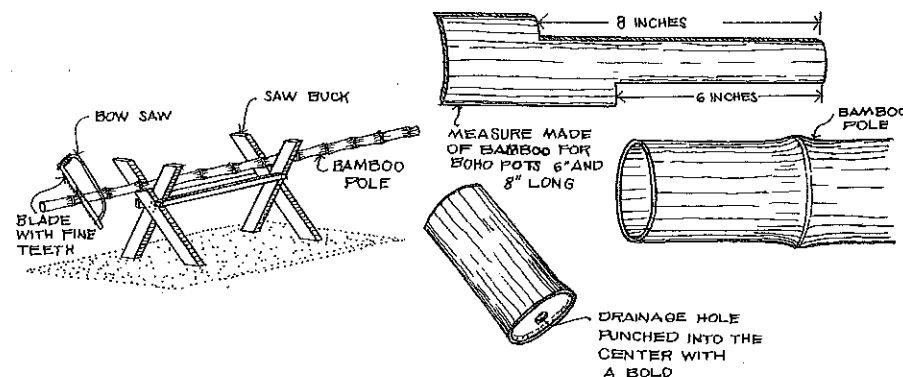

Fig. 21: Preparation of boho pots

As far as possible the cuts are made in such a way that a node will be at either end of the pole section to form the bottom of the pot. In the center of this base a drainage hole is punched with a bolo. Sections of correct length without nodes can be utilized by tamping one inch of soil at the lower end of the cylinder to form a kind of bottom.

c) Tin cans: Tin cans of various sizes can be collected at garbage places or from restaurants, hospitals and the like. Although tins can usually be obtained without difficulty and at a low cost, their preparation will be quite costly and

time consuming. A disadvantage in the nursery is that they easily heat up to harmful degrees, which might through increased soil evaporation cause a quick drying.

All this makes them unsuitable for mass production. For special purposes, however, like for the propagation of fruit trees or ornamentals to be distributed to the public, large tin cans are useful and may still hold their place.

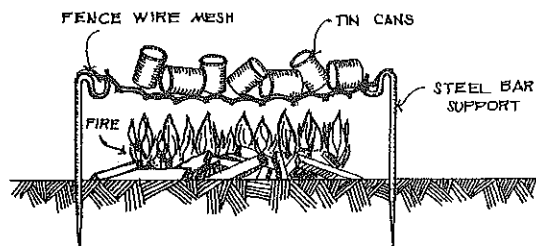

Fig. 22: Sterilization of tin cans

To kill or neutralize all harmful substances left in the tins they are burned over a fire. For this purpose some wire mesh is put on top of some iron supports, under which the fire will be lit. The tins are turned with a bamboo pole from time to time until they turn grey or black. Through burning the tins also become soft and rust quickly, so that they can be easily cut or broken to remove the

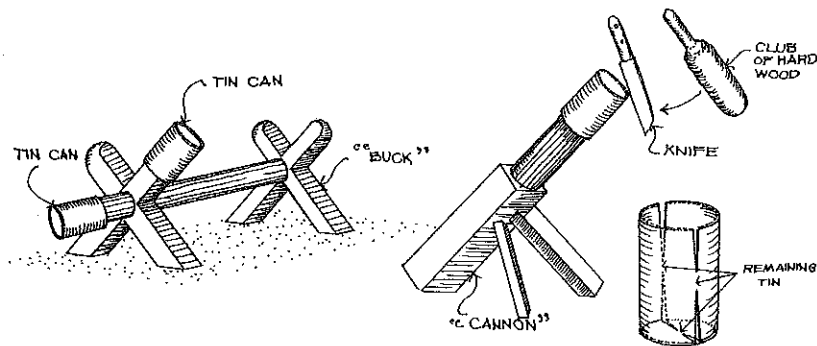

Fig. 23: Devices for the preparation of tin cans

earthball at planting time. The bottom and sides are provided with slits for drainage. These slits should be long enough and arranged in a way, that the tin can easily be taken apart at planting time by cutting the remaining portion between the slits with a bolo. The preparation of tins is facilitated by devices shown in fig. 23.

- d) Veneer tubes: The use of veneer tubes is very recommendable where cheap waste veneer can be obtained from nearby plywood mills. The veneer sheets, usually 1-2mm thick, are cut with a special cutter into pieces of the required size. The standard size for a plant pot is 35 x 20 cm with the grain parallel to the 20 cm edge. The tubes are formed by wrapping the veneer around a wooden cylinder of 5-8 cm diameter and fastening the ends with a stapler.

When a soft organic material like veneer is used for pots, planting will be facilitated, because the containers need not to be removed before planting but can be allowed to rot in the ground.

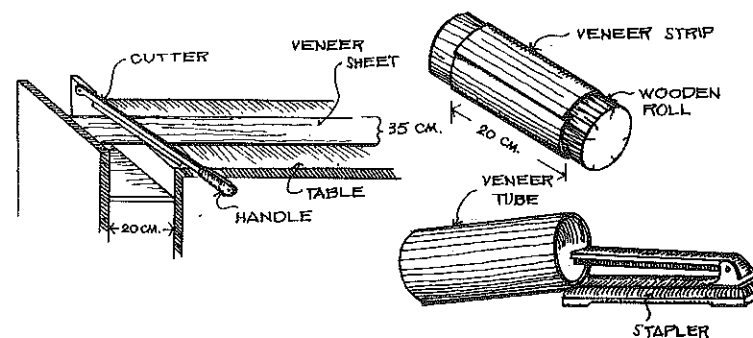

Fig. 24: Manufacture of veneer pots

## 6.2 Potting soil

- a) The supply of potting soil: in adequate quality and quantity is one of the main problems in raising potted plants considering that for the production of 1 million seedlings about 500 cubic meters of potting soil are required.

Where the services of a dump truck are available, soil can be obtained from distant places. If the soil, however, has to be brought in by wheelbarrows there should be a good source of topsoil close to the nursery.

Good topsoil is generally found only under forest where it is taken from the upper 15-30 cm. Before collection the topsoil is examined on the spot. Its physical condition and humus content can be judged by the earthball test and by thorough inspection. It should have the characteristics of loam or sandy loam, its reaction should range between pH 5.5 and 6.5 (slightly acidic). Topsoil with a pH value of over 7 should not be taken, because it would be very difficult and costly to lower the soil reaction. If the pH value is too low, it can be raised by adding lime.

The topsoil is screened at its source through a coarse sieve with a  $\frac{1}{2}$  inch mesh fitted to a wooden frame of appr. 1.00 by 1.50 m in size to exclude roots and stones. The screen is set up with an inclination of about  $45^\circ$ , and the soil is thrown with a shovel against the wire mesh. It is also possible to hang the sieve under a tripod scaffolding or truss.

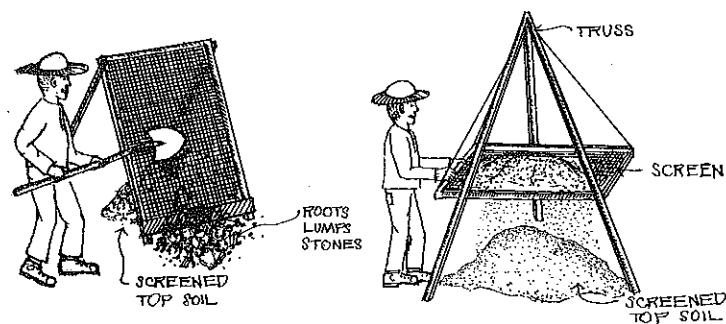

Fig. 25: Screening of topsoil

b) Soil shed: After screening the topsoil is transferred to the soil shed, where it is stored until it is needed. At the beginning of the rainy season there should always be a sufficient amount of topsoil stored in the shed to last for the time when it is too wet to collect soil in the open. In addition, there should be all the time an adequate supply of coarse river sand and compost at hand, so that poor topsoil can be improved.

A soil shed or potting shed is a very important installation and should be constructed in every nursery where potted plants are to be grown. It can be a simple shelter made of bamboo poles and thatched with cogon or palm leaves. For a more durable structure one can use 2" by 2" timber and corrugated iron sheet. There should be 5 spacious compartments for topsoil, sand, compost, ready mixed potting soil and empty containers. The soil compartments can be constructed of wooden planks, or better, of hollow blocks reinforced with iron. Under the same shed there must be enough space for soil mixing, screening, potting, etc. There should also be a water tap nearby. It is very important that the soil shed can be reached by motor vehicles for unloading soil.

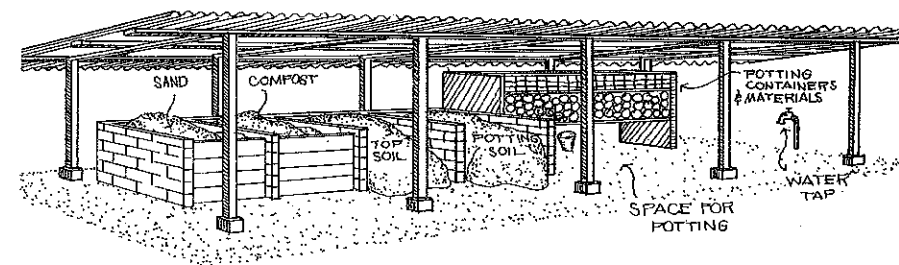

Fig. 26: Soil or potting shed

c) Improvement of potting soil: Topsoils of clayey as well as those of sandy nature are not favorable for potting. Clayey soils tend to become compact and then absorb water only slowly. When the pots are irrigated from above by sprinkling, the water will often hardly moisten the upper 5 cm, while the lower portions in the container usually remain dry. But since their water holding capacity is high, they easily become too wet during rainy periods. Clay soils can be improved by adding sand and compost.

Sandy soils also have their disadvantages. They have a low water holding capacity and easily dry out. They can heat

up quickly under the sun, which, besides scorching the stem tissues, will accelerate soil evaporation. The main disadvantage of sandy soils is, that the earthball will quickly crumble and fall apart, when the container is opened during field planting. Although their unfavorable nature can be amended by mixing them with loam and compost, outspoken sandy soils should better be avoided.

There is no ready formula for mixing the ideal potting soil, because the quality of the topsoil, which is the basic component, can vary considerably. Topsoil which already has all the desirable properties may not need to be improved at all. The suitable mixing proportions have to be found by test and experience. For an average topsoil one can try the following mixture (43):

- 6 parts forest topsoil,
- 1 part sand,
- 1-3 parts compost,
- 2-4 heaped tablespoons of a complete fertilizer (N,P,K) per 5 gallon cans of soil.

The components have to be all thoroughly mixed. A cement mixing machine is useful, where large quantities of potting soil have to be prepared.

### 6.3 Potting techniques

- a) Potting place: Potting has to be carried out under shade, either in the potting shed or under movable or permanent

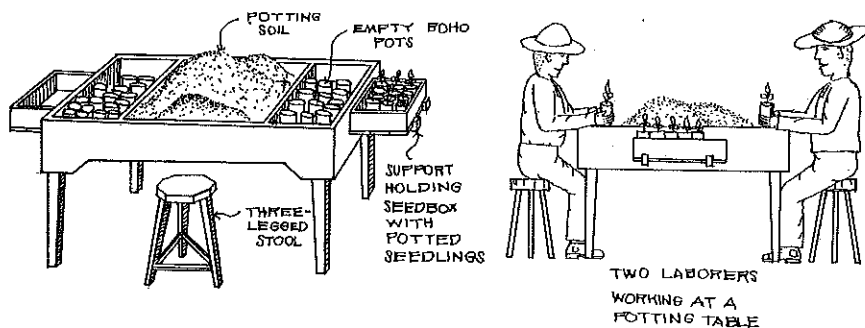

Fig. 27: Potting table

high shade scaffoldings erected directly over the pot beds. The potting shed should be furnished with potting tables containing a larger compartment for the potting soil and two smaller ones on either side for the empty and filled pots. On each potting table two laborers can work together facing each other and sitting conveniently on a kind of stool.

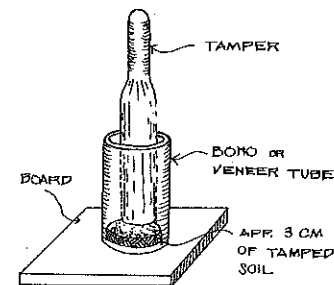

Fig: 28: Filling a veneer pot

- b) Filling the containers: Boho cylinders and veneer tubes, that do not have a bottom, are filled at first only to a height of about 3 cm. With the help of a round piece of wood the bottom soil layer is compacted, after which the pot is filled up and the seedling planted.

Layflat plastic bags can be conveniently filled with an iron or bamboo funnel. With the pointed end of the funnel the bag is opened and the potting soil filled in through the opposite end.

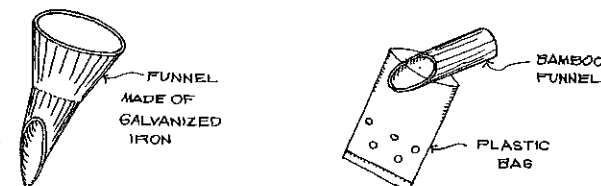

Fig: 29: Funnel for filling plastic bags

- c) Large and small seedlings: The technique of potting is slightly different according to the size of the seedlings.

With large seedlings first, the bottom of the bag is filled with potting soil. Then, while the left hand holds the seedling at the correct level, the right hand fills soil around the roots up to the rim of the container.

Small seedlings are potted the following way: The container is filled up to the rim with potting soil, into which a hole

is made with a dibble. The hole must be large enough to accommodate the roots of the seedling. This technique is especially suitable for agoho, bottle brush or eucalypts, which are generally potted as very small seedlings.

- d) Potbeds: After potting, the seedlings are transferred to shaded pot beds (Fig. 30).

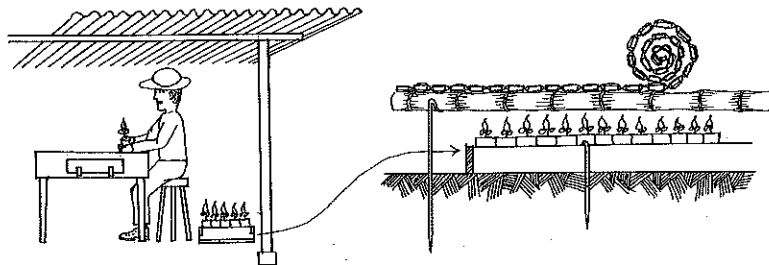

Fig. 30: Transferring the seedlings to shaded potbeds

Those seedlings potted under high shade erected over the whole pot bed area or under a movable shade, which is moved as the potting proceeds, will be placed right away into the pot bed.

"Pot beds" are constructed by fitting curbs to the ground along both sides and at the ends of the bed as already described for seedbeds. In the absence of curbs small earth mounds would also provide the necessary support for the pots.

Pots containing small seedlings of slow growing species are usually crowded together. Containers with large seedlings of fast growing species must be given some spacing to avoid the formation of long etiolated stems, which may not be able to support their own weight. For a firm stand the pots are buried with their lower portion in the ground.

- e) Care after potting: The pot beds are watered immediately after transplanting and shaded for some time. The shade should be gradually removed when the seedlings have established themselves and thrive.

After some weeks the pot beds are checked and pots with withered seedlings are taken out. Potting soil and pots are saved and stored in the soil shed. The remaining pots with seedlings are arranged according to size.

## Chapter 7:

### CARE AND MAINTENANCE OF SEEDLINGS

During their stay in the nursery, apart from weed and pest control and fertilizer application, the transplanted seedlings require watering, shading, mulching, sometimes thinning, soil cultivation, root pruning and finally hardening-off before field planting.

#### 7.1 Watering

Moisture in the root zone is needed to maintain vital life processes of the plant organism like transpiration, which causes the circulation of the sap stream transporting plant nutrients and assimilates and has a cooling effect on the leaf surface. Water is also needed for the formation of carbohydrates in the photosynthetic processes. It is important, that the daily rates of water consumption and water absorption are balanced. If water is consumed at a faster rate than the roots are able to supply, the leaves will start wilting, and, if this continues, the plant will die.

In the nursery this equilibrium between water consumption and water absorption can be established by either reducing the rate of transpiration (shading of newly germinated or transplanted seedlings) or by maintaining an appropriate level of soil moisture by irrigation, where rainfall is insufficient. In addition, one can lessen water losses through evaporation by mulching, soil working, and improving the waterholding capacity of the soil.

There are two basic ways of irrigation: surface irrigation and overhead irrigation. The layout of irrigated nursery beds has been described in Chapter 2.

- a) Surface irrigation: The water flows on the soil surface to percolate vertically (flooding) or horizontally (furrow irrigation) into the soil, until it reaches the roots of the seedlings.

In "flood irrigation" the water is directed from a main ditch into the flood beds, where it is allowed to cover the whole bed area for some time until it has thoroughly percolated into the root zone. Under suitable conditions (ample water supply, large seeds, sturdy seedlings or transplants) flooding is a practical and time saving irrigation method, though it can have some undesirable effects. Fine sediments might be left on the bed surface after the water has disappeared clogging the soil pores and forming a crust. Weed seeds may accumulate on the beds, when the irrigation water on the way to the nursery passes through grassland. If the water stands for too long in the beds, aeration of the soil may be hampered. In flood beds that are too long and not completely level the quantity of water received by individual seedlings may differ greatly. If the bed level is sloping too much, fast flowing water may cause erosion (9).

In furrow irrigation the water does not cover the entire bed surface, but flows in furrows between the rows of seedlings or between the raised seedbeds or transplant beds from where it percolates horizontally into the soil. This method has the advantage of causing no sediment nor any disturbance on

the bed surface. Water can stand in the furrows for a longer time than would be suitable for flood beds.

- b) Overhead irrigation: Watering from above should be carried out in a way that no water accumulates on the soil surface, i.e. that not more water is applied than the soil can immediately absorb to avoid the formation of a crust, sedimentation, compaction and erosion. The nozzle of the sprayer or the rose of the sprinkler must be constantly kept in move (4). Regarding the size of the droplets we can distinguish between spraying (fine droplets) and sprinkling (coarse droplets).

Spraying: The water is dispersed as a fine mist that settles gently onto the leaves of seedlings and the soil surface. Spraying is the correct way of watering delicate seedlings in their early stages. Spraying implements are the different types of hydraulic pressure sprayers used in pest control, like syringes, knapsack sprayers or high pressure sprayers.

Sprinkling: means the application of water in a form resembling raindrops (9). Various implements and devices serve as sprinkling gear.

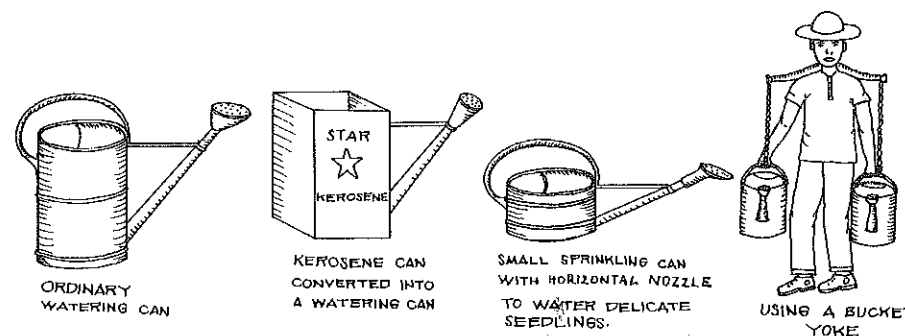

Fig. 31: Types of watering cans

The ordinary type of watering can is used for transplants or potted seedlings. Its rose should have fine openings to obtain a fine sprinkle, which does not compact the soil

surface. Carrying water cans is facilitated by a bucket yoke (see fig. 31). The cans are filled from a faucet or better filled by dipping them in a concrete basin constructed in front of the hydrants to save time.

Sprinkling can be facilitated by using a rubber hose. However, since the jet, as it comes out of an open hose is too strong and too compact and damages seedlings and soil structure, the hose end must be equipped with an adjustable nozzle or a rose. There are also special sprinkling attachments, which can be fitted to the hose by a quick coupling device. Controlling the jet by just holding the thumb over the hose is not a good practice.

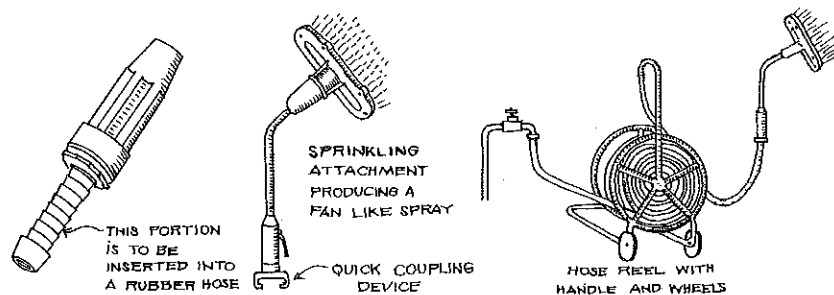

Fig. 32: Adjustable nozzle, sprinkling attachment, hose reel with wheels

Automatic rotary sprinklers, oscillators or perforated pipe systems can be installed, where the water pressure is sufficiently strong (30 psi or more). The spray produced can cover several nursery beds. The water will already be absorbed by the soil, when after one rotation the spray returns. With permanent over head sprinkling installations only a switch has to be turned to water whole nursery compartments at once. A minor disadvantage is that the paths between the beds, if not cemented or paved, become muddy.

- c) Considerations about water requirements: There is no fixed rule about the intervals between waterings and the quantity of water required, because this depends on many variable factors like weather conditions, species, soil conditions,

age of plants, etc. The correct watering schedule for a nursery can only be determined through careful observation and experience (4,13).

Correct watering supplies the seedling with just enough water for unrestricted growth. Well watered seedlings look healthy and vigorous. Excessive watering results in tender, overgrown, succulent plants, sometimes of a yellowish color. Insufficient watering becomes obvious through wilting and stunted growth. However, the slight wilting of young leaves during the middle of the day, when transpiration is highest, is quite normal and does not cause any harm (4).

The quantity of water required for transpiration varies with the species. Legumes, eucalypts, agocho, teak, molave, Benguet pine need less water than kaatoan bangkal, gubas or dipterocarps, for example. Naturally, rain forest species have a higher rate of transpiration than those indigenous to the molave forest.

The water requirements depend also on the seedling's size and stage of development. Small seedlings just past the germination stage want small quantities of water at frequent intervals. Larger seedlings need more water for adequate growth. Their roots extend down to deeper soil layers, where moisture is kept for a longer time. They must therefore be watered less often, but amply and thoroughly.

With surface irrigation the soil is generally well saturated with water. Sprinkling and spraying sometimes does not supply the quantity of water the seedlings need. The moistening of the soil surface can be misleading. What counts is, how much water percolated into the root zone. Especially with potted planting stock one has to check after watering, whether the root zone really received enough moisture. Often the edges of the beds receive much less water than the center portions.

Soils differ greatly in their water holding capacities. Ideal are soils that quickly absorb water and are capable

of storing a large quantity of water available to the plants, but allow drainage of excess water. Friable sandy loams rich in humus with a good crumb structure can absorb water like a sponge. They need to be watered less often.

Sandy soils are able to absorb quickly plenty of water, but a great portion of it will drain into deeper layers, where it will be out of reach for the seedlings. Nursery plants on sandy soil therefore require frequent waterings.

Loamy soils can absorb only a comparatively small amount of water at a time, but the water holding capacity is high. Since water percolation in loamy soils is slow, they must be subjected to irrigation water for a longer time.

Weather conditions also strongly influence water requirements. When transpiration and evaporation are high on hot and sunny days, naturally the plants need more water than during cloudy weather. Desiccating winds during the dry season also increase water requirements. Seedlings should be watered in the early morning or late afternoon, but not during the middle of the day, when high water losses through evaporation cannot be avoided.

It is the responsibility of the foreman to decide every morning which of the nursery beds have to be watered, and to mark them with a bamboo peg with a painted red top to avoid that watering is done mechanically.

## 7.2 Mulching

Mulching in nursery practice means covering the bed surface with a 0.5-2 cm layer of organic material. This reduces evaporation of soil moisture and shields the soil surface from sun, wind and the impact of raindrops. Like a sponge a mulch cover can quickly absorb plenty of water, which then passes slowly into the soil.

Mulching avoids high soil temperatures generated on the bed surface by the intense tropical sun, which might affect the root collars of young seedlings. It also provides protection from rain preventing surface and splash erosion and the formation of a soil crust.

Soil organisms like bacteria, fungi, earthworms quickly multiply and start decomposition within the mulch and the upper soil layer. The activities of the organisms cause beneficial changes in the structure of the upper soil layer improving hereby aeration and the water absorbing and water holding capacity of the soil.

The following materials can make a suitable mulch:

- Grass, rice straw and rice husk are widely used mulching materials, because they can be easily obtained in most places. One should never use grasses that bear ripe seeds.
- Compost and partly decomposed forest litter make an excellent mulch. They should be used wherever they can be produced or obtained. Very desirable is compost, which not only absorbs and holds moisture, but also supplies the soil at the same time with humus and nutrients.
- Sawdust can be used as mulch, provided it does not come fresh from the sawmill. Before use, it must be composted or piled in a thin layer for about one year in the open, so that harmful components e.g. acids, resins, latex, tanning substances will either be neutralized by decomposition or washed out. Sawdust, when incorporated in the upper soil layer, loosens heavy soils and increases the water holding capacity of sandy soils.
- Tissue paper or newspaper are sometimes employed as a mulch cover for fine seeds of Caşuarina, Alnus, Eucalyptus, Cryptomeria broadcast in open seedbeds. After germination the plumule pierces the paper mulch and continues growing.

Grasses and straw are chopped coarsely with a bolo on a wooden block and spread in a thin layer on top of the beds. When a seedbed sown with fine seed is to be covered, the mulch layer should not exceed 0.5 cm. For larger seeds like those of teak, mahogany, narra it can be thicker. In transplant beds the mulch is spread between the rows of seedlings. Potted seedlings could be mulched too, but this would be time consuming and costly.



When fresh, green organic materials are placed on the bed surface or are incorporated in the upper soil layer (rice husk, sawdust), decomposition will be immediately initiated mainly by rapidly multiplying bacteria. Like other plant organisms they need nitrogen for their development. They usually draw it from the underlying soil stratum as the only source, where this element is available in a form, which at once can be utilized. This vigorous bacterial activity can cause a marked nitrogen shortage, which may become obvious through yellowing of leaves and needles. One can avoid this effect by a moderate top dressing of a nitrate fertilizer (e.g. sodium nitrate, calcium nitrate) of about 20 g per square meter. Later, during the advanced stages of decomposition more and more nitrogen is set free by the breakdown of the organic mulch substances and can be used by the bacteria, so that the quantity of nitrogen taken from the soil will decrease and finally stop. At last, the decomposed mulch becomes a fertilizer itself.

### 7.3 Shading

Nursery beds are shaded to prevent young seedlings from being damaged by direct sunshine and heat. The effects of too strong sunshine become visible as heat lesions near the root collar, as scalds on the leaf surface, or as wilting due to excess water losses by transpiration.

Heat injuries near the root collar are caused by high soil temperatures. In an experiment carried out in Malaysia, the mean soil temperature at 5 cm depth in an open nursery bed reached 37° C at 1:00 p.m. with a maximum of 43° C. However, palm thatch shades over the nursery beds were able to reduce it to 29° C (max. 30° C), while 31° C were measured under shading mats providing a 50% shade (BARNARD, 1956).

Sun scald can appear on the leaves of young, tender seedlings which are not yet equipped for hot sun rays. It can also be observed, when transpiration, which has a cooling effect on leaf surfaces, is reduced, while the leaves have to endure the full strength of the sun. This can happen,

when sunlight touches delicate leaves immediately after a rainfall. They cannot yet fully transpire, because the surrounding atmosphere is still saturated with moisture.

Wilting occurs when the water losses by transpiration cannot immediately be replaced. This is often the case with newly transplanted seedlings, which have yet to establish themselves and to develop new hair roots.

Shading is required usually only during the most delicate growth stages, which is during and shortly after germination and after transplanting. Afterwards the seedlings should be given all the light they can tolerate without harm, because sunlight is necessary for optimal photosynthesis, and the plants must be fit to bear the full sunlight, when planted in the field.

However, exposing them to more light has to be done gradually. The light intensity can be increased by using mats which provide more light and by extending the period of exposure progressively. Seedlings, that have germinated under shade, or those that show already signs of etiolation are likely to suffer a serious setback, if they would be exposed too suddenly.

Experience in proper shading can be obtained only by closely observing the physiological reactions of the plants to environmental changes regarding their exposure to sunlight. One also needs some intuition for the light requirements of the plants.

In nursery practice it is common to distinguish between high shades and low shades.

- a) High shades: are erected high enough that a laborer can move freely below in upright position. The superstructure of high shades, which often are a permanent installation, is built of poles or wooden posts about 2 m apart and connected at the top with girders. When seedlings are to be shaded, shading mats or screens can be placed on top of the scaffolding.

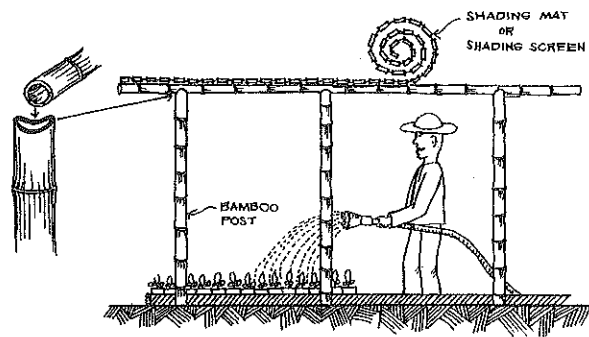

Fig. 33: High shade constructed of bamboo poles

The laborers can carry out all kinds of nursery work under high shade. Seedlings can be potted here and placed immediately into the prepared pot beds. When the plants are to be watered or weeded, no shading mat has to be removed.

But high shades also have some disadvantages. The shading intensity cannot easily be modified and adjusted to changing weather conditions because of the height of the scaffolding.

Another difficulty arises where the bed runs in east-west direction. Here, one has to have also a screen on the southern side, particularly from October to March, when the sun is low.

- b) Low shades: In contrast to high shades the cover of low shades is spread on some kind of supports only 30-50 cm above the ground. Only the bed area is covered, the paths are spared. Low shades can be quickly spread and removed according to the changing weather conditions and light requirements of the seedlings. Therefore low shades should be given preference to high shades.

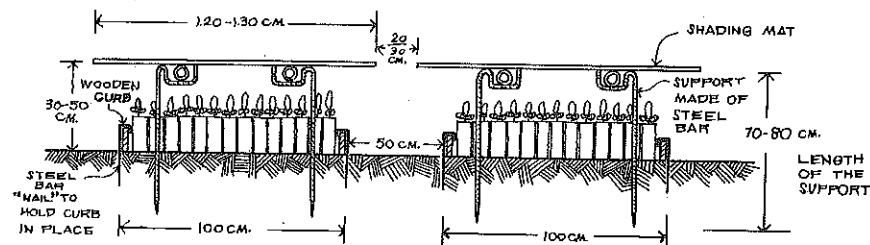

Fig. 34: Low shade with temporary supports (cross section through pot bed)

It is but a slight disadvantage that the shade mats must be removed when the seedlings are to be watered or weeded. Water applied on top of the shade mat as a sprinkle might be transformed into heavy drops, which compact the soil and dislodge the seedlings. However, during torrential rains the shading mats should be spread to provide some protection.

The supports for the shading mats can be either installed permanently or used as temporary supports, which can be removed easily when required. A permanent support is constructed of pegs driven into the ground and slats nailed on top of them. Instead of slats one can use straight bamboo poles tied to the pegs with vines. This kind of support is applicable only to pot beds that do not require soil working.

Very practical are supports made of iron bars. They are stuck, pushed or driven into the ground temporarily, as long as the seedlings are to be shaded. Their tops have the form of a semi-circle or open rectangle, into which bamboo poles are placed (fig. 35).

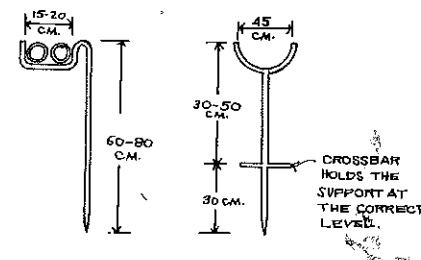

Fig. 35: Temporary supports for shading mats made of steelbar

c) Shading mats: should become the common shading cover in forest nurseries, though their manufacture will be more expensive than just getting some palm leaves or cutting some ferns and grasses. But in the long run, the use of shading mats will save money and prove to be more adequate.

Shading mats can easily be spread and quickly rolled up again when required. The degree of shading can be further modified according to the increasing demand for light or the growing hardiness of the seedlings by exchanging mats that provide much shade (60-75% shade) for others allowing more light to pass (e.g. 40-50% shade).

Shading mats can conveniently be made of bamboo (boho) poles. With a bow saw the bamboo is cut into pieces of 1.20-1.30 m length considering that the shading mat must be slightly wider than the nursery bed. With a bolo the bamboo pieces are split into slats 15-20 mm wide, which are smoothed by planing their sides and cutting the edges of the internodes. Another good material is runo.

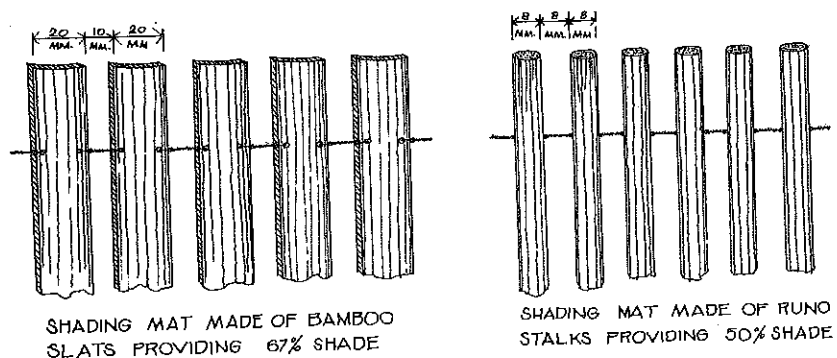

Fig. 36: Shading mats

The slats are connected with nylon string (wire, abaca fibre, pack string), whereby some space is left between each slat. The width of the slats and the space left in between determine the degree of shade the mats will provide. A mat made of 20 mm wide slats with spaces of 20 mm in between permits 50% of the light to pass. If 20 mm slats are tied at 10 mm

intervals, a 67% shade will be provided. Shading mats should not exceed 5 m, longer mats are too heavy and inconvenient to handle.

d) Shading screens are made of interwoven bamboo or runo, or cogon stalks held together by runo sticks. The light permeability of self-made shade screens can similarly be modified by putting the slats closer together or wider apart. They should have a convenient size (more or less 100 by 150 cm) so that they can be manipulated without difficulty.

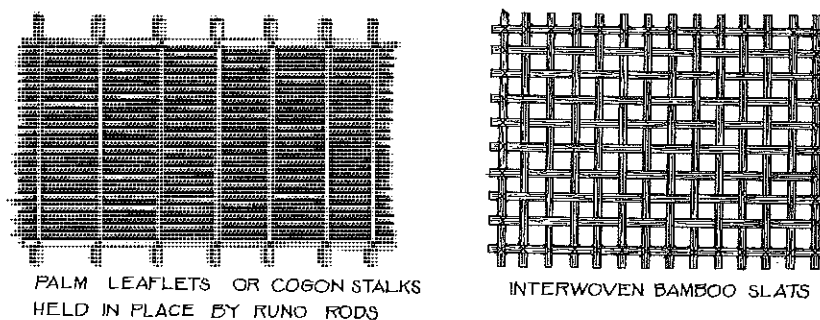

Fig. 37: Types of shading screens

Shade screens can be placed horizontally on high or low supports like shading mats, or they are set up in a slanting position facing south, which is of advantage during the time from October to April when the sun is low in the northern hemisphere. Beds shaded this way are also easily accessible for watering, pest control, weeding, etc..

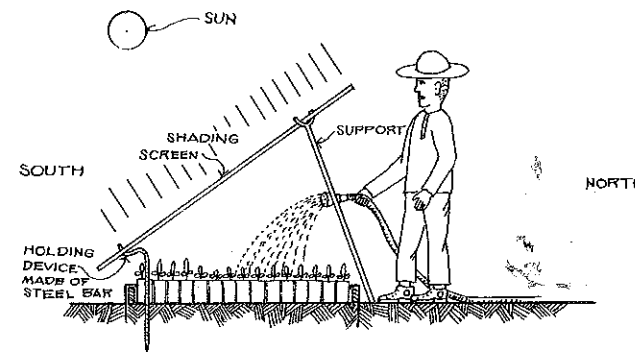

Fig. 38: Setup of a shade screen in slanting position

#### 7.4 Protection from strong rains

The very high rainfall intensities in the Philippines make protection against rain a special issue in nursery work.

Rain can wash away the soil cover exposing newly sown or germinating seed. Exposed seed often does not germinate, uncovered germinating seed will wither and dry up. Broadcasted small seeds can be swept by excess water off the bed surface or washed into dense patches. Some seed may be buried by sediments from higher portions so that the plumule is unable to penetrate.

Heavy raindrops can knock young seedlings to the ground. Splash erosion may cause their stems to be clad and girdled with "soil pants". Under full sunshine this soil mantle can heat up to injurious levels.

The impact of falling raindrops breaks down the porous structure of cultivated soils impeding water infiltration and gaseous exchange. On drying the soil surface tends to form a crust.

There are several ways to prevent the damage, at least in part.

- a) Shelters and protective covers: The shelter of a greenhouse would be the most ideal place to grow fine-seeded species during their delicate seedling's stage up to the time of transplanting. Where this facility is lacking one should erect at least a shelter with a roofing of fibre glass or strong plastic sheet (gauge 0.003 or 0.004) fastened to a wooden frame, under which a table-like structure with the seedboxes is placed.

Permanent seedbeds can be protected too during heavy rains with plastic sheets fastened to a portable frame. The cover has to be immediately removed after the rain to avoid the built-up of high temperatures.

To a certain degree shading mats can also mitigate the impact of heavy rains. An excellent practice is to put a

polyethylene sheet of appropriate width between two shading mats. Some stones are placed on top to keep everything in place should gusty winds come up. Other types of protection like high shading sheds can be designed according to needs and available funds.

- b) Proper layout of nursery beds: To minimize erosion the nursery area should be level or should have only a slight gradient. Where the site is sloping, the land must be levelled by the construction of terraces. Run-off usually accumulates between the raised nursery beds and flows towards the lower ends of the paths. From here it should be conducted into stable ditches and canals.

#### 7.5 Weed control

Weeds compete with the seedlings for nutrients, water and light. If they are not removed in time, this competition will turn into suppression of the nursery plants, because the weeds are usually more vigorous and grow faster.

- a) Kinds of weeds: The most cumbersome weeds are grasses or dicotyledonous plants that grow from a rootstock. They creep and spread by means of underground stems and rhizomes. If such a weed is cut off at the ground surface, it will sprout again and continues growing from the carbohydrates stored in its root tissues. These "root weeds" must be removed with their rhizomes and eradicated as soon as they appear.

The elimination of weeds which propagate only by seeds ("seed weeds") is much easier, because their root system will die, when the shoot is cut with a weeding tool.

- b) Prevention of weed infestation: As much as possible one should prevent dispersal of weed seeds in the nursery. Unfortunately, most weeds produce seeds prolifically, which are easily dispersed by wind and water, and are also brought in through mulch and manure.

No weeds should be allowed to flower and fruit along paths and roads, on unused parts of the nursery, or in its immediate surroundings. Grassy areas should be regularly cut and trimmed, free compartments are better cultivated with an agricultural or green manuring crop. This improves the soil, keeps the weeds down and makes proper use of the fallow period.

A tall thick hedge around the nursery can keep out much weed seed, which would otherwise be brought in by wind. Irrigation water running in open canals passing through weed infested areas must be filtered through a fine mesh wire screen before it is distributed in the nursery. Grasses or other organic matter to be used as mulch or for compost should be free from weed seeds.

Nursery land infested with rhizomes (*Imperata*) must be thoroughly worked, sometimes two times, and all rhizomes carefully removed before the beds are laid out. Adjoining grassland must be lined with concrete curbs reaching at least 20 cm deep into the ground, so that no rhizomes can penetrate into the cultivated land. The walls of terraces should not be stabilized by grasses but with a dry stone wall (riprap) and the rims capped with concrete. Irrigation canals within the nursery should be of concrete too, otherwise a vigorous weed flora would develop along their banks.

Soil in seedboxes and greenhouse beds can easily be kept free of weeds by steam sterilization.

- c) Mechanical weed control by hand: When the nursery is cleared of all rhizomes, from then on weeds can only propagate by seeds. All newly appearing weeds should be eradicated shortly after their germination. Under no circumstances should the weeds be allowed to grow tall oppressing nursery plants and sending their rhizomes deep into the ground. A small weed seedling can be removed with hardly any effort, but to dig up large weeds is expensive and time consuming. It is obvious that under these conditions weeding has to be repeated more often. A regular turn of 2-3 weeks depending on the local climate

and soil conditions will generally be sufficient to catch up with the newly germinated weeds, and the nursery will always look clean.

Pulling out the weeds by hand is rather costly and should be limited to seedbeds, where the seeds have been broadcast, or to weeds germinating within the drills, where they cannot be reached with a weeding hoe. Also weeds growing on containers have to be pulled out by hand. In weeding seedbeds and transplant beds by hand the laborers should sit on a small weeding stool, which is more comfortable and convenient than squatting.

The optimum soil conditions for weeding are met, when the soil is neither wet nor dry, but just slightly moist.

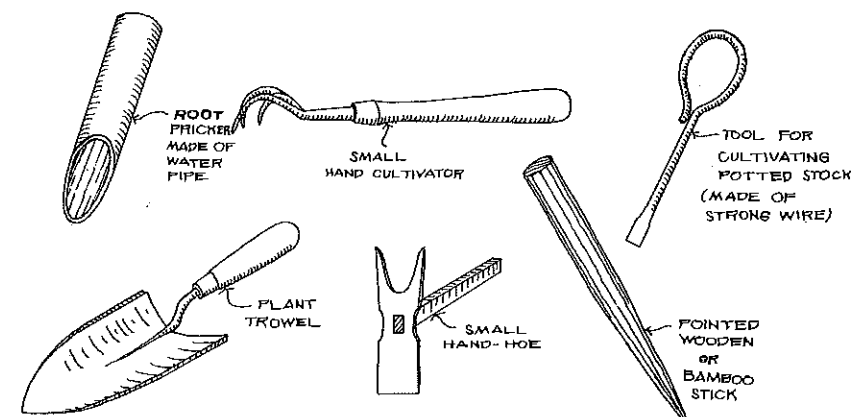

Fig. 39: Tools to aid hand-weeding of firmly rooted weeds.

In transplant beds and in seedbeds, which produce stock for field planting with sufficient space between the lines, weeding is carried out with a light, long-handled weeding hoe. It consists of a small, thin blade of good steel and a thin long handle, and can be easily be manufactured by a local mechanic shop. The tool, however, is unsuitable for the eradication of tall, deep rooting weeds.

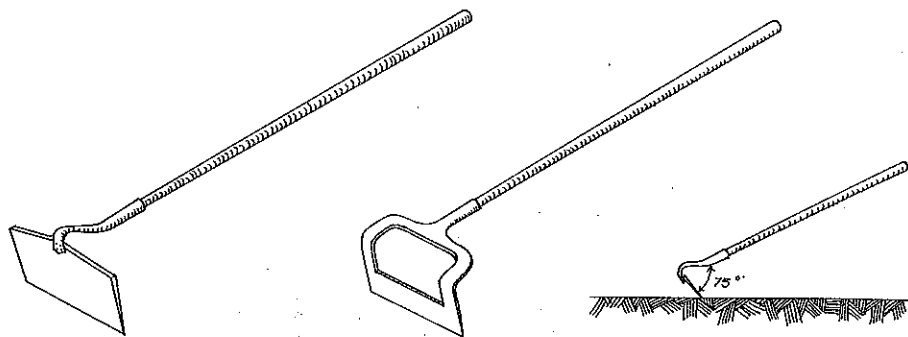

Fig. 40: Types of light weeding hoes

Small weeds are uprooted by hoeing and cultivating the upper 2-3 cm of soil between the rows of seedlings or by simply scraping the soil surface 1-2 cm deep with short strokes. The beds should be cultivated that way every 14 days. Except for some weeds growing within the rows of plants no weed must be pulled out by hand any more. The beds should be cultivated when the sun shines, so that the uprooted weeds will dry up quickly.

Light longhandled weeding hoes can be operated only, if the distance between the rows of seedlings is not less than 20 cm. The hoes have a width of 10-13 cm, an allowance of 3-4 cm on either side is necessary to avoid plant injury.

Compared with the usual practice of weeding in squatting position with a bolo, the use of a light weeding hoe offers several advantages: Because of the light weight of the tool and the upright working position, the work will be less tiresome and the laborers can maintain their working speed throughout the day. One laborer can manage to keep at least 0.5 ha of nursery area permanently clean. There is no problem with catching up with tall weeds. The weeds are eradicated before they start oppressing the plants. Soil crusts are regularly broken up and the surface soil loosened, thereby

also reducing the evaporation of soil water. Although the beds are worked every two weeks, this method is cheaper than the ordinary practice of eradicating the weeds when they are already tall.

- d) Mechanized soil cultivation and weed control: In large, level nurseries motor cultivators, tillers and rotary hoes, self-propelled or attached to a tractor can be used for weeding and cultivating transplant beds, provided the rows of seedlings run lengthwise. There are cultivators, which can work only one strip between two rows or those that work the width of the transplant bed at once. Multiple-purpose "implement carriers" belong to the second group. Their wheels run on the paths on both sides of the transplant bed, while the rotor-hoes work the soil between the rows (25).

In the large nurseries in Europe and the United States motor-operated cultivators have largely replaced hand-tools. In the Philippines the introduction of these machines appears not so urgent. They would have to be imported, are expensive and can be used economically only on large, level areas.

- e) Chemical weed control: The relatively high cost of mechanical weeding and shortage of forest workers forced forestry in Northern Europe and the United States to look for weeding methods, that would save money and labor. Inspired by successful chemical weed control in agriculture forest research institutes in those countries have been working intensively on this subject during the past two decades. It was found that certain herbicides are capable of reducing weeding expenses also in the forest nursery, provided the necessary precautions are observed and appropriate techniques of application employed (14).

The problem is still to find herbicides that are easy to apply and act selectively destroying only the weeds without harming the seedlings. It appears, that up to now weed killers that are strictly selective, have yet to be developed.

Most herbicides can also affect the seedlings adversely, especially when higher doses are applied, which are necessary to kill persistent weeds.

In the Philippines herbicides are expensive, and it is often difficult to obtain them in the provinces, while on the other hand a large labor force is looking for employment at relatively low rates. Special equipment is needed, and the laborers have to be thoroughly trained on the subject before they can be allowed to work with weed killers. There is always the danger that forest seedlings are damaged by an overdose or careless application. Under the present conditions, the use of herbicides cannot be recommended in Philippine forest nurseries. Weeds in the nursery can still easily be controlled by using the light weeding hoe, which should remain the standard weeding practice.

#### 7.6 Root pruning

Root pruning as a measure of tending and maintenance of nursery plants cuts the lower portion of the root system, particularly the tap root, to stimulate root ramification and the formation of a compact root system, while the seedling is still growing in the nursery.

This treatment is of great importance when seedlings are raised in the seedbed without transplanting. But also in transplant beds root pruning is desirable. Seedlings intended for "stumps" are not root pruned.

The term root pruning is also applied for cutting back tap roots and long lateral roots of bare root seedlings after they have been lifted from the nursery bed. This work is described in Chapter 8.

- a) The objective of root pruning: The seedlings of most tree species tend to send down quickly long tap roots to deeper soil layers, where water is likely to be more easily and permanently available. Naturally root growth is concentrated more on the tap root than on lateral roots. When the seedlings are lifted, much of the tap root has to be cut to

facilitate field planting. What remains is rather unsatisfactory: a root system with a spindle-like main root and very few lateral roots, which will not be able to meet the water requirements of the plant.

Good quality plants have a compact, well ramified root system with many root hairs. The condition of the root system, in particular that of its absorbing surface, the hair rootlets, through which water and nutrients are taken up, determines to a large extent, whether a seedling will survive field planting or not.

Pruning stimulates root ramification and makes the root system to become compact and fibrous rather than long and thin (10). It was found, that Mahogany seedlings started to develop two or more new roots within two weeks at the point where they had been cut, and many new roots above this level (ASIDDAO and JACALNE, 1958).

As root pruning retards the growth of the tip and at the same time stimulates root growth, it improves the shoot/root ratio of the plant. The best plants are those, which have a relatively small top and a large fibrous root system. Such seedlings have a small transpiring surface, but many hair rootlets to absorb water and nutrients. Their survival in the field is markedly better than that of unpruned seedlings (10).

- b) Root pruning in transplant beds: While the seedlings remain in place, the roots are cut underground with a sharpened spade or bolo. The pruning level should not be too deep nor too shallow ranging from 10 to 30 cm below the soil surface depending on the species and the size of the seedling.

The spade is thrust into the soil towards the center line of a row at an angle of about 45° starting approximately as far away from the seedling as the intended pruning depth. The spade must be well-sharpened. Vertical cuts between the seedlings are to shorten long lateral roots (10).

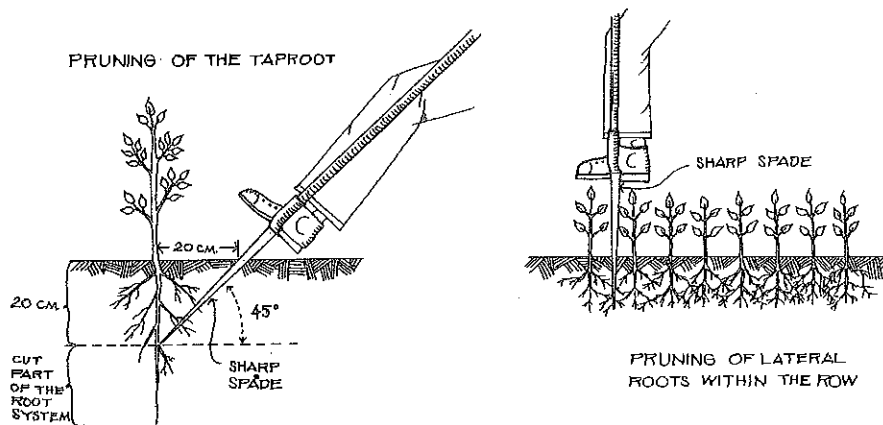

Fig. 41: Root pruning in a transplant bed

Small seedlings growing in loose, friable soil can also be root pruned with a bolo. The bolo is thrust into the soil at one end of the row and slid all along to the other end by moving it quickly up and down with short strokes. Turning around this process is repeated on the other side of the row (10).

c) Root pruning of potted seedlings: Some time after potting the roots of potted seedlings tend to grow through the drainage holes of the containers and penetrate into the ground of the pot beds. These roots must be cut from time to time, usually every two months.

The pot is lifted and placed back after the roots growing out of the container have been cut with pruning shears. The "shocking" method just tears the roots that have already grown into the ground.

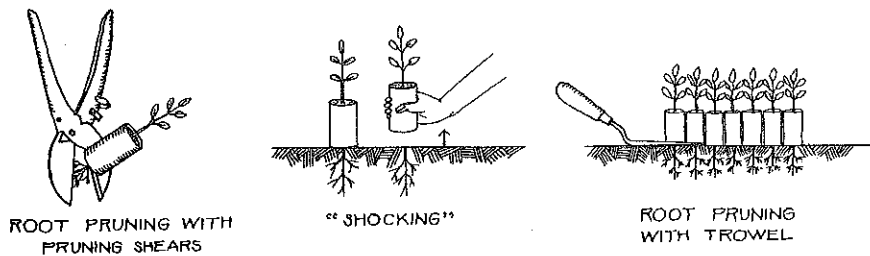

Fig. 42: Root pruning of potted seedlings

It is also possible to avoid root pruning of potted seedlings altogether by placing the pots on a plastic sheet or a cemented surface. Another method places the pots on a slightly raised wire screen to avoid a direct contact with the soil. However furnishing all pot beds with such floorings is rather expensive.

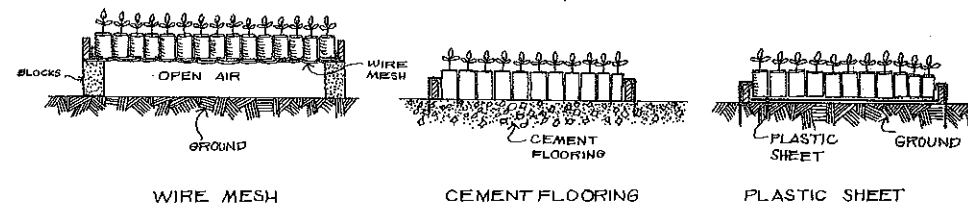

Fig. 43: Potted seedlings placed on mesh wire, cement flooring or plastic sheet to avoid root pruning

As a rough guideline, root pruning is to be carried out about 2-3 months before field planting, so that the plant is able to replace the loss by developing new lateral roots. If it is carried out too early, new tap roots may develop.

Since root pruning reduces the water absorbing surface of the root system, it should be carried out on a cloudy day when transpiration is low. If signs of wilting occur afterwards, the plants must be shaded and watered.

### 7.7 Hardening-off

When the seedlings are set out, they will abruptly leave the favorable environment of the nursery and have to grow under the hard conditions of the field. To accustom the seedlings to this new situation they are subjected to a little "rougher" a treatment one or two months before field planting.

Hardened seedlings of desirable quality are not succulent, but have firm lignified tissues, they are not weak, spindly or oversized, but have a sturdy, stocky, well developed crown with vigorous, healthy leaves or needles, and a compact root system with many fine, fibrous, lateral roots. The top/root ratio is well balanced. The following treatments should be applied:



- a) Reduction of irrigation water: A month or two before field planting the amount of water that has been usually applied to the plants is progressively reduced. By this treatment shoot growth will be delayed and the plant tissues will harden, so that the seedlings can withstand dry spells after planting without having their tops killed back.
- b) Cut-off of fertilizer applications: Generally no more fertilizer is applied after the initial dose, which has been mixed with the potting soil or worked into the transplant bed before transplanting. An overhead application of complete fertilizer may be necessary for species that need a long time to grow into plantable size. But no nitrogen fertilizer should be applied within two months before field planting, because nitrogen would cause the development of soft succulent tissues.
- c) Exposure to full sunlight: Seedlings should be given all the light they can tolerate. After transplanting and potting the seedlings have to be shaded for a while. But as soon as they have recovered and commenced growth, they should be progressively exposed. At least one month before field planting the seedlings must be accustomed to full light.
- d) Cutting back of shoots: Sometimes seedlings become oversized because of improper timing of the sowing date, over-fertilization, or as "left-over stock" due to lack of funds during planting time. Aside from root pruning, a possible remedy for broad-leaved species is cutting part of the shoots some time before field planting, while the seedlings are still in the nursery. This is preferable to trimming the shoots after lifting, because the plants will overcome the "cutting shock" better under the more favorable conditions of the nursery. Shoot pruning should be carried out together with root pruning in one operation. It cannot be applied to conifers.

During the hardening stage the reaction of the plants must be well observed with a kind of intuition or instinct to do the right thing, not too much and not too little. Hardening starts slightly, but the treatments are gradually intensified without harming the seedlings. The changes must not come abrupt, but subtle.

## Chapter 8:

### PREPARATION OF PLANTING STOCK FOR FIELD PLANTING

#### 8.1 Culling and grading of nursery plants

Nursery stock of low quality and in poor condition should not be used as planting material. The money spend for planting will probably be wasted to a large extend. Poor seedlings do not have the reserves to overcome transport and "planting shock". The few survivors, the condition of which may be also substandard, grow slowly and must be weeded and tended for a longer period than faster growing plants of good quality. All losses have to be replaced at higher cost. It is more economical to plant just a small area, but to do it only once using quality plants. In judging the quality of planting stock, the following points should be considered (26):

- a) Health: The planting material should be free from diseases and insect infestation. Discolorations of the leaves or needles or a weak, etiolated crown can indicate improper treatment in the nursery, nutrient deficiency or infested roots. The plants should also be free from mechanical injuries and lesions, especially on the stem. Slight injuries can be remedied by trimming and root pruning.
- b) Freshness: Wilted or half dried-up plants are useless, they will not survive. Before lifting, the seedlings should be thoroughly watered, so that their cells will be filled with moisture. After lifting they should be immediately trimmed, packed and carefully protected from sun and wind to reduce water losses by transpiration and evaporation.

- c) Root system: The root system should be compact without a long tap root, but with many fibrous lateral rootlets. A compact root system can be accommodated more easily in the planting hole. The more fibrous roots are present in the root system, the better the immediate take up of moisture and nutrients on the planting site.
- d) Crown: Like the root the crown should also have a compact regular shape with many side branches. Of importance is the diameter of the stem. It should be relatively thick and woody. Robust plants are much heavier than etiolated plants because of a larger stem diameter. In sturdy plants more reserve food is stored, which enables the seedlings to overcome the planting shock more easily and to develop quickly new root hairs. To grow seedlings in the transplant beds with well-shaped crowns and sturdy stems it is essential to provide them with the necessary space.
- e) Top/root ratio: The best general criterion of plant quality is the ratio between shoot and root length. This ratio should be well balanced. In general, the larger the root system compared to the crown, the better the quality of the plant. Set out in the field, such a plant will resume growth sooner than top-heavy plants, which usually will first die back. The die-back of the shoot of misproportioned seedlings is a kind of natural balancing of the top/root ratio. However, water losses can be so much during this process, that the seedling may not survive at all.
- f) Size and age: The specific conditions of the plantation site require seedlings of a certain size. On dry sites and places with much grass competition larger seedlings are preferred. Undersized seedlings are discarded or retained in the nursery, until they are large enough for field planting. Oversized broadleaved seedlings have to be trimmed.

The size of a seedling is usually correlated to its age, although there can be variations from nursery to nursery and season to season due to soil quality, nursery management and

weather conditions. Where nursery plants differ much in size, it is advisable to grade them to facilitate packing, transport and planting.

## 8.2 Bare root seedlings

- a) Lifting: is the removal of bare root seedlings from the seed-bed or transplant bed. It requires careful planning and good organization. Only as many seedlings should be lifted at once as there are laborers for culling, grading, trimming, pruning, mud-puddling and packing. Although the roots should not be exposed at all, it cannot entirely be avoided, but the exposure should not be longer than absolutely necessary.

The soil of the nursery beds should be moist (not wet), so that the seedlings will be turgid, lifting will be eased and root damage avoided. With dry soils the most important and valuable parts of the root system, the hair rootlets are easily torn off.

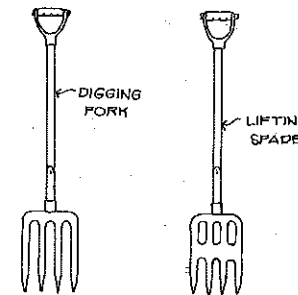

Fig. 44: Digging fork and lifting spade

Suitable tools for lifting are digging fork and lifting spade, which are designed to avoid root damage. Large plants growing in heavy soil are better lifted with an ordinary sharp spade.

After the plants have been eased out of the soil with the help of a digging fork and a light pull on the shoot, loose soil is carefully shaken off leaving only fine particles of earth adhering naturally to the rootlets.

b) Trimming and pruning of roots and shoots: Long tap roots and long lateral roots, which are difficult to accommodate in the planting hole and likely to be curled, are pruned with a clear cut. Damaged roots receive the same treatment. The work is demonstrated in Fig. 45.

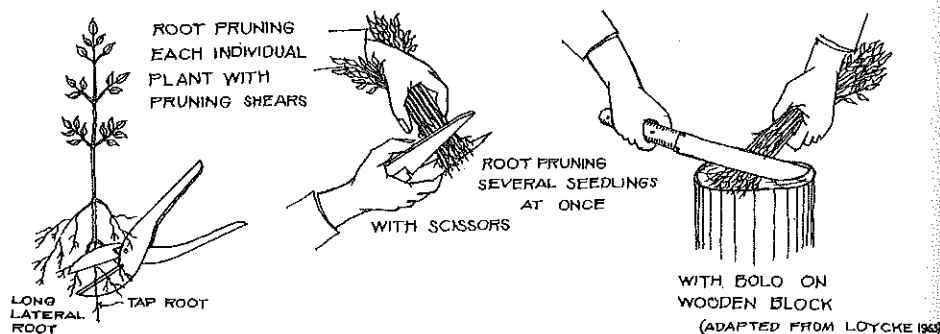

Fig. 45: Root pruning of bare root seedlings

The loss of root substance has to be compensated by pruning parts of the shoot accordingly. The crown must not transpire more water than the roots can absorb. Furthermore, a great portion of the stem usually consists of soft, not yet lignified tissues with young only slightly cutinized leaves, which will transpire much water. This soft part of the stem should be cut back. As soon as the plant has established itself in the field, the stem will sprout again and develop a new leader. Or, with large leaved species sometimes one half of each leaf is cut, but this is a rather costly method. Shoot pruning can only be carried out with broadleaved species.

c) Mud-puddling: The objective of mud-puddling is to protect the roots of bare root seedlings from desiccation between lifting and field planting.

A hole about 50 cm in diameter and 30 cm deep is dug. Pulverized loamy soil (no clay) together with some decomposed cowdung is filled into the hole up to 3/4 of its depth. Whenever necessary a soil insecticide can be added. Water is poured in and the soil is stirred, until it has the

consistency of a wet paint. After having been pruned and trimmed, the seedlings are dipped in bundles with their roots into the mud. The mud coating, however, is only thin and does not replace careful handling and packing of bare root seedlings. It has been experienced, that conifers do not respond well to mud-puddling, because their roots require much oxygen (2).

d) Packing and transport: The kind of packing can be modified according to the prevailing weather conditions, the transport distance, and the time the seedlings have to stay in transit. The roots have to be particularly well protected, when the weather is hot and dry and the distance to the planting site very long.

Bare root seedlings are bundled and packed by 10, 20 or 50 plants per bundle depending on weight and size. Around the roots some moisture retaining material as wet grasses, leaves, chopped rice straw or saw dust is placed. In mountainous regions moss is an excellent material. It should be collected well in advance of the planting season, sun-dried and stored in sacks. Before use the moss is soaked in water, excess water squeezed out by hand, and the moss "fluffed up".

The seedlings with the moisture retaining material are wrapped in wet burlap sacks. Two bundles of seedlings can be accommodated in one wrapping, the roots facing each other in the middle of the bale (Fig. 46).

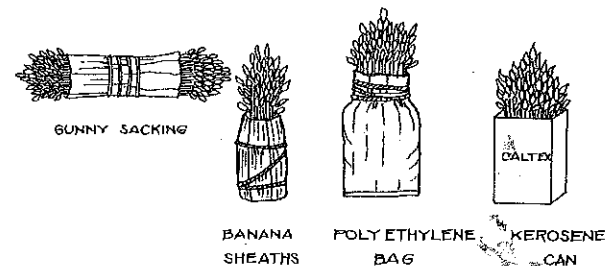

Fig. 46: Wrapping and packing of seedlings

Other wrapping materials are banana sheaths, large leaves or grasses. The seedlings can also be packed in kerosene cans, buckets, pails or, what is very common, in bamboo baskets lined with moist grass or moss.

Hauling seedlings to the planting site over long distances, especially in the mountains, often involves hard labor. Wherever possible carabaos and horses should be employed for this kind of work.

Seedlings which have to be transported over long distances by truck are loaded on a rack especially constructed on the loading platform of the vehicle allowing the transportation of several layers of seedlings. It is very important that the seedlings are protected from desiccating wind during the drive by a closed tarpaulin. The plants must be watered during transit whenever necessary.

e) Heeling-in: The term is applied, when bare root nursery stock is temporarily set in moist soil under shade to keep it fresh until it can be used for planting. Heeling-in at the planting site may become necessary, when the weather condition suddenly turns unfavorable for planting or a big load of seedlings cannot be planted at once. Seedlings should not be left in the packages for more than two days.

Generally heeling-in should be avoided. The plants will suffer, if the heeling-in place is not really moist and shady. In any case bare root planting material should not remain heeled in for more than a week.

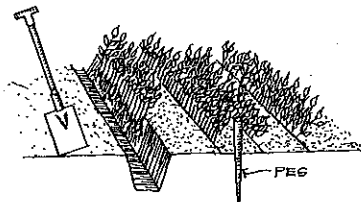

(ADAPTED FROM LOYCKE, 1963)

Fig. 47: Heeling-in

The following technique is generally adopted: Under a shade tree a trench is dug with a hoe, shovel or spade in loose, well drained, but moist soil. On one side of the trench, which should be slightly sloping, the plants are individually arranged in up-right position. The roots are then covered with soil taken from the opposite side of the trench hereby creating room for the next row of plants. The roots are covered up to their root collar and the soil is firmed with the hands before the next row of seedlings is placed. A wooden peg marks every 100th seedling to facilitate counting. During dry weather the seedlings have to be watered (26).

### 8.3 Stumps

Stumps are seedlings of which most of the shoot and more or less all lateral roots have been cut back, so that only a short piece of the main root is left. Stump planting is only possible with some broadleaved species with a high regenerative capacity. The best known example is teak, but planting stumps of narra, mahogany, ipil, African tulip, *Gmelina arborea* has also been tried successfully.

Seedlings intended for stumps are raised at a wide spacing with or without transplanting - to attain a diameter at the root collar of 1 - 2.5 cm. They are lifted with a digging fork or simply pulled out. Seedlings that have not yet reached the desired diameter can be left in the bed for some more time.

The stem is severed about 2 cm (*Gmelina* 5 cm) above the root collar with a slanting cut. If a longer part of the shoot is left, the stump may produce several sprouts. The lateral roots are shortened to about 2-5 cm, with teak they are removed entirely. The main root is also shortened to a length of 15-25 cm.

After they have been mud-puddled the stumps are wrapped in bundles of equal number in teak or banana leaves.

Stump planting has considerable advantages, because stumps are easier to transport and to handle than bare root seedlings.

One man can carry 600-700 stumps from the nursery to the planting site. They are harder and can tolerate even shipments of two to three weeks without damage provided they are well packed. On favorable sites twice the number of stumps as compared to bare root plants can be planted in a day, thus reducing planting costs. Generally the survival of stumps is better than that of bare root plants. Unfortunately, the number of species that can be planted by stumps is quite limited (6).

#### 8.4 Earthballed plants

Earthballed plants are lifted with a ball of earth around their roots from the nursery bed or the forest (wildlings). Like the planting of potted stock, this method disturbs the root system only little provided the earthball does not fall apart.

The preparation of balled stock is expensive and time consuming. Much care is needed to preserve the earthball. Often each ball has to be wrapped separately to prevent it from breaking and drying out. The use of balled plants in the Philippines is therefore limited only to large ornamental shrubs and trees, and to the use of wildlings.

The soil making up the earthball should not be dry and of loose texture like that of sandy soils. Loamy soils make good earthballs. Balling is only possible when the soil is moist and has some consistency. The balling methods differ with regard to the size of the plant:

- Balling of small plants: Small plants can be cut out of the soil with a bolo or a spade. With a bolo a circular

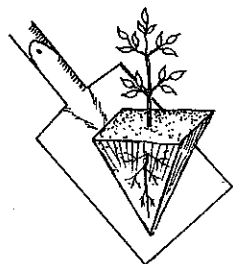

Fig. 48: Balling small seedling with a garden spade

cut is made around the seedling, which then can be lifted with a cone-shaped piece of soil. With a garden spade only four cuts are necessary and the seedling can be lifted with an earthball in the shape of an inverted pyramid. Also circular spades (see Section 2, Chapter 10) are useful tools for balling. For transport the balled seedlings are placed tightly together on a plant tray.

- Balling large plants: At a distance from the stem necessary to preserve most of the root system a circular trench is dug around the plant until the earthball is laid free. Still in the earth-hole, the ball is wrapped with gunny sacks, plastic foil, leaves, grasses or similar material and tied with a string or with fibers.

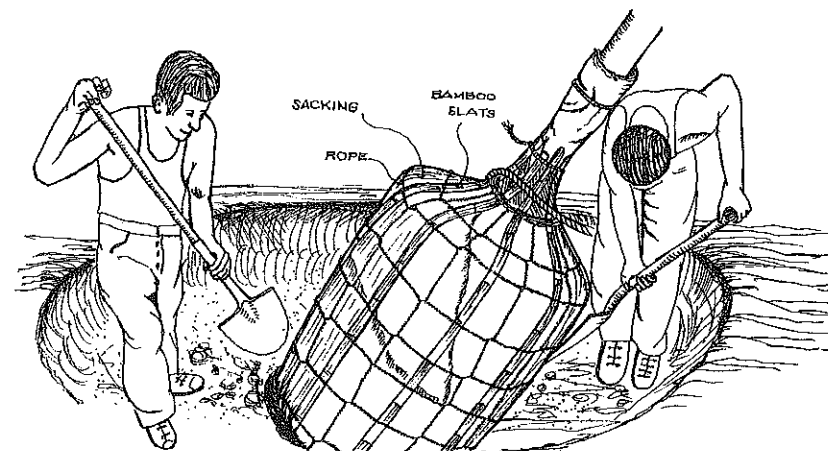

Fig. 49: Balling of young tree (adapted from DELIZO, 1964)

#### 8.5 Potted plants

Potted stock does not need much preparation, provided hardening measures, particularly root pruning was carried out in time. After a thorough watering, the pots are taken from the pot bed and placed in upright position in bamboo baskets or wooden boxes, or on racks constructed on the loading platform of a motor vehicle. Plants in boho pots, veneer tubes or tins can be bundled together in convenient numbers.

SOIL - ITS CHARACTERISTICS AND PROPER MANAGEMENT  
IN THE FOREST NURSERY

Soil can be defined as the weathered upper layer of the earth's crust that is capable of supporting plant growth. Within this "upper layer" above the more or less unweathered parent material two horizons can be distinguished: the subsoil and the surface soil or topsoil.

The surface soil comprises the uppermost 20-30 cm of the soil profile. It usually has a darker color than the underlying subsoil because of the accumulation of humus. When we speak about "the soil" of a forest nursery, we commonly refer only to the surface soil of the seedbeds or transplant beds or to the topsoil used for potting.

As a medium for raising tree seedlings the soil performs four functions: It serves to anchor the roots, supplies water to the plants, contains air for their breathing, and furnishes the minerals for plant nutrition (21).

9.1 Mineral soil particles

- a) Minerals and elements: Soil consists mainly of a mixture of inorganic particles of various sizes. These particles are composed of minerals like quartz, feldspar, orthoclase, hornblende or secondary clay minerals like kaolinite, montmorillonite and illite, which in turn are compounds of various elements like silicon (Si), aluminium (Al), calcium (Ca), magnesium (Mg), sodium (Na), phosphorus (P) and iron (F). Some elements are important plant nutrients.

- b) Size of soil particles: Referring to their size the soil particles are generally classified as follows:

|               |           |          |
|---------------|-----------|----------|
| - Stones      | more than | 20 mm    |
| - Gravel      | 2 -       | 20 mm    |
| - Coarse sand | 0.2 -     | 2 mm     |
| - Fine sand   | 0.02 -    | 0.2 mm   |
| - Silt        | 0.002     | 0.02 mm  |
| - Clay        | less than | 0.002 mm |

- c) Physical properties of soil particles:

- Stone, sand and gravel will not change at all when subjected to moisture. They do not expand when wet, nor shrink when dry. Their water holding capacity is low. Water can infiltrate fast because of the large spaces between the particles. Nutrients are easily leached. Gravel and sand, however, form the skeleton of soils and facilitate drainage and air movement.
- Silt actually constitutes a kind of micro-sand. Since the fine particles lie close together, there is little space in between, aeration is therefore poor. The water holding capacity is higher than that of sand, but still low compared to clay.
- Clay expands and becomes sticky when wet. On drying it shrinks and becomes hard and cloddy. The water holding capacity of clay soils is high, but much water is held so tightly that it is not available to plants. Because of their relatively large surface area clay minerals have the capacity to absorb plant nutrients and prevent them from being washed out. This explains why the presence of clay minerals is important for sustained soil fertility.

9.2 Texture classes:

The term soil texture refers to the relative proportions of different size classes in a representative soil sample. The following texture classes can be distinguished:

- a) Sands: At least 70% of their weight consists of gravel and of coarse or fine sand, the rest may be clay or silt. A sandy soil with at least 90% sand is simply called sand, one with a lesser sand fraction termed loamy sand.

The physical properties of sands can be improved by the addition of humus and of soil with a high proportion of clay.

b) Loams are a mixture of sand, silt and clay particles. The sand content ranges from 30 to 50 percent, the clay fraction is less than 40 percent, the rest is silt. According to the proportion of sand, silt and clay within these ranges we can distinguish sandy loam, loam, silt loam and clay loam.

- Sandy loam and loam are favorable soils for raising tree seedlings. They have the desirable qualities of both sand and clay without exhibiting their undesirable properties such as low water holding capacity on one hand and stickiness, compactness, slow water take-up and poor aeration on the other.

- Silt loam and clay loam have to be improved by adding sand and humus in adequate quantities, if they are to become good nursery soils, otherwise they would be too heavy.

c) Clays are soils, in which more than 40% of their weight consists of particles below 0.002 mm. Clay soils are hard to work and cultivate. They become sticky and puddled when wet and hard when dry. After a heavy rainfall the pore spaces of the surface are clogged and most of the rain water runs off. In dry condition the surface forms a crust and cracks. The plumules of germinating seeds have difficulties in pushing through this crust.

Clays are not suitable for nursery soils and should be avoided by all means.

For the identification of the different texture classes see PLANTATION TECHNIQUES, Chapter 2.

### 9.3 Soil structure and pore space

Between the solid particles, the minerals and organic matter, there are small spaces, the soil pores, which are filled with water and air. In addition, soil contains a teeming population of fungi, bacteria and animals. In an ordinary silt

loam garden soil with optimum conditions for plant growth solid particles make up only one half of the volume, while the other half consists of pores.

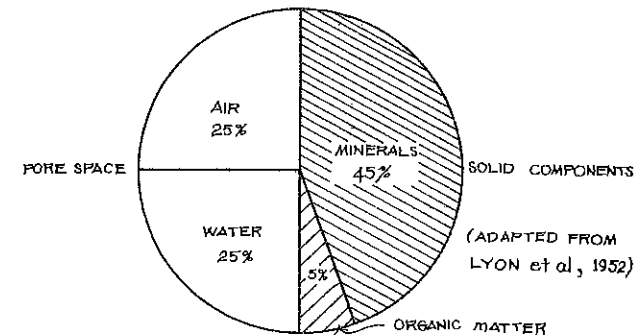

Fig. 50: Pore space and solid components in a good garden soil

There are larger and smaller pores. Large pores (larger than 0.6 mm) are necessary for good drainage and aeration, small pores (smaller than 0.6 mm) for the water supply. In small pores through capillary action water moves in any possible direction to soil zones with a lesser moisture content.

For plant growth it is essential that the soil has a structure with large and small pores at the same time. Ideal nursery soil shows a crumb or granule structure, wherein minerals and humus particles form aggregates that are relatively water-stable and leave many pores of various sizes. The formation of a crumb structure is encouraged mainly by the presence of humus, earthworms and micro-organisms.

### 9.4 Humus

Humus originates mainly from plant substances. In the presence of moisture and fresh plant tissues the micro-organisms, especially fungi and bacteria, multiply manifold. In digesting the carbohydrates of the plant tissues (sugar, starch) they take up oxygen and release carbondioxide ( $CO_2$ ), water and energy (heat). This decomposition of organic matter, that generates heat at the same time, can somehow be compared with a slow burning process. The remaining "ashes" are inorganic compounds and humus.

Humus is a dark-colored, amorphous mass of very fine decomposed organic particles that has very favorable physical properties. Humus colloids do not stick together like clay. Whether wet or dry, humus will always be in a loose, fluffy condition. Its water holding capacity is very high.

The ability of humus colloids to absorb nutrients is far higher than that of clay minerals, because humus colloids are much smaller in size than clay particles and therefore have a greater absorbing surface.

Furthermore, humus colloids have the tendency to unite with clay particles to form water-stable crumbs, that will not disintegrate during rainfall or when the nursery beds are watered.

Unfortunately, under tropical conditions humus aggregates are not very stable. The hotter and more humid the climate, the less humus is generally found in the soil. On some lowland sites the humus appears to "mineralize" mainly by the action of certain bacteria almost as quickly as it is formed. Rain forest soils therefore often have only a very poorly developed A-horizon. In higher elevations, however, where temperatures are lower, humus appears to be more stable. A thick A-horizon can be found in some places under mossy forest above 1000 m.

Under the conditions of the tropical lowland the humus content of a nursery soil has for this reason to be constantly replaced by the addition of compost or similar organic matter.

#### 9.5 Soil organisms

A vast number of small organisms inhabit the soil. The more important groups are earthworms, fungi, bacteria and actinomycetes.

- a) Earthworms: Minerals and organic matter passing through their digestive tracts are transformed into aggregates with a very favorable structure and rich in available plant nutrients. The holes in the soil produced by earthworms increase aeration and drainage. Soil of deeper layers is brought to

the surface and vice versa. Earthworms like moisture. They can usually be found in great numbers in loams with a high humus content.

- b) Soil fungi decompose all kinds of organic materials. Cellulose, starch, gums and lignin readily succumb to their attack. Moulds are numerous especially in higher elevations with lower temperatures, while bacteria dominate under the hot tropical conditions of the lowland.

By forming a symbiosis known as mycorrhiza some fungi grow within and around the roots of trees. Both partners benefit from this association: the fungus draws carbohydrates from the tree, while the tree in turn is provided with nutrients and water (28).

Some tree species like pines, in particular *Pinus merkusii*, cannot grow beyond the early seedling's stage where the symbiotic fungi are lacking. In these cases the nursery soil has to be inoculated with soil obtained under established pine trees, or tall balled seedlings with mycorrhiza around their roots are planted at 1 m intervals in the transplant beds to provide the newly planted seedlings with the beneficial fungus. Mycorrhiza soil to be used for inoculation will remain active during transport, when it is kept moist and packed in plastic bags. It should be brought into contact with the roots of the seedlings as fast as possible. The mycorrhiza soil is either added to the potting mixture or worked into the transplant beds after it has been thinly spread over them.

- c) Actinomycetes: Except bacteria no other micro-organisms are so numerous in the soil as actinomycetes. They liberate nutrients, especially nitrogen, by decomposing complicated organic compounds.
- d) Bacteria: are single cell organisms, the simplest and smallest forms of plant life known. They multiply just by division. Under favorable conditions (moisture, warmth, presence of organic material) large populations rapidly build up.



Besides the break-up of all kinds of organic materials, which also includes the mineralization of humus, soil bacteria are responsible for three basic chemical transformations essential for plant nutrition (27):

- Nitrification: Nitrogen in the form of ammonium ( $\text{NH}_4$ ) is changed into nitrate ( $\text{NO}_3$ ), which can be taken up by plants;
- Sulfur oxydation: Sulphur is made available out of complicated sulphur compounds;
- Nitrogen fixation: Some bacteria are capable of binding some of the elementary nitrogen of the atmosphere with other elements, so that it can be taken up by plants. Some of the nitrogen-fixing bacteria are active only in the root nodules of certain species like legumes and alders, others live freely in the soil.

### 9.6 Soil reaction

Soil moisture is not merely pure water, but actually a solution of salts and minerals. It can have an acidic, neutral or alkaline reaction. The soil reaction is expressed by the pH value. The following graduation is used:

| pH value    | Soil reaction     |
|-------------|-------------------|
| less than 4 | very acidic       |
| 4-5         | acidic            |
| 5-6         | moderately acidic |
| 6-7         | slightly acidic   |
| 7           | neutral           |
| 7-8         | slightly alkaline |
| more than 8 | alkaline .        |

a) Determination of pH - value: By a simple test using red and blue litmus paper one can find out, whether a soil is acidic, neutral or alkaline. Two clean glasses are partly filled with a soil sample, that has been screened and divided into two portions. Distilled water or rain water is added, while a red litmus paper is placed in one glass and a blue paper in the other. After one hour the papers are checked:

- if the papers did not change color - neutral reaction;
- the blue paper became red - acidic reaction;
- the red paper became blue - alkaline reaction.

However, the litmus paper test as described above does not provide the desired information about the actual degree of acidity, the pH value of the soil. This can be easily determined with a color indicator (pH-meter). It is cheap, easy to handle and provides fairly accurate results.

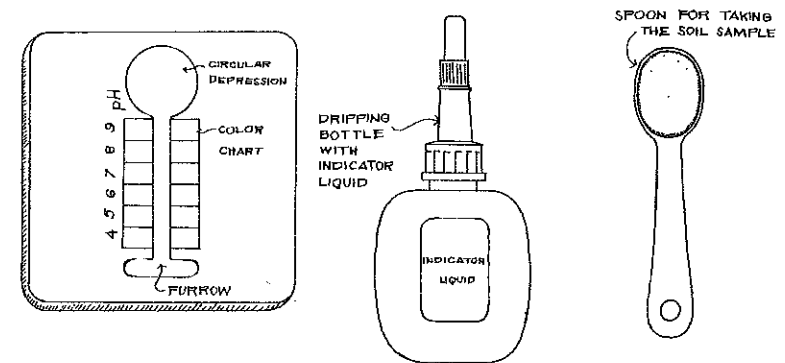

Fig. 51: Color - indicator to determine the pH value of soils

A color indicator consists of a small spoon for taking soil samples, a dripping bottle filled with indicator liquid and a white plate with a circular depression, which extends into a small furrow (see fig. 51). On the plate there is a scale with colors, which range from red to blue-green indicating the numbers of the respective pH values. A soil sample is placed in the depression on the plate, and indicator liquid added. After three minutes one side of the plate is lowered a little, so that the liquid, which usually will have changed its color, will run into the furrow along the color chart. By comparing the colors the pH value can be determined.

b) Suitable range of pH value for tree seedlings: Neither very acid nor alkaline soils are suitable for the propagation of forest tree seedlings. Where the soil reaction is very acidic, or alkaline, certain plant nutrients and trace elements are either leached or become insoluble.

- Acid and very acidic soils (below pH 4.5) are low in exchangeable calcium and magnesium, and lack most of the important plant nutrients like nitrogen, phosphorus, potassium, sulphur and the trace elements (copper, zinc, boron). Only iron and manganese are available. Fungi are not much affected by acidity, but bacteria and actinomycetes cannot thrive under such conditions. Toxic side effects may occur through the development of organic acids.

- Alkaline soils, the other extreme, with a pH value above 7 also have their problems. Although soil bacteria and actinomycetes can develop freely and nitrogen, potassium and sulphur together with calcium and magnesium will be readily available, there is often a distinct shortage of phosphorus, iron, manganese, copper, zinc and boron.

- A moderately to slightly acidic reaction (pH 5.5 to 6.5) represents the most favorable condition. Within this range all the vital elements are available to the plants, provided these elements are not lacking at all. There is a slight difference in the pH range required by pines and broadleaved species. Most pines prefer a soil reaction between pH 5 and 6, broadleaved species generally like it a little less acid, somewhat between pH 5.5 and 7.

c) How to modify an unfavorable soil reaction: Since most forest seedlings thrive best in the intermediate pH range of 5-7, it may become necessary to adjust the soil reaction of a nursery soil. As much as possible one should however avoid soils that differ markedly from the desirable pH range. It is generally easier to raise the pH value than to lower it

- Raising the pH value: The pH value of soils can be raised by adding lime or fertilizers that reduce acidity such as sodium nitrate, calcium nitrate, or basic slag.

- Lowering the pH value: We can change an alkaline or neutral soil reaction by the application of acid forming fertilizers such as ammonium sulfate, ammonium nitrate and urea.

All these are nitrogen fertilizers, and care must be taken not to over-fertilize the seedlings with nitrogen. A chemical very effective in lowering the pH value is flower of sulfur.

No definite recommendations can be made regarding the amount of lime or fertilizer to be applied to yield the desired change in soil reaction, since the buffering of soils, i.e. the resistance to a change in soil reaction, is quite variable. By treating a small area with different amounts and by determining the pH value again after a few weeks, one has to find out the quantity required to achieve the desired results.

#### 9.7 The role of plant nutrients and deficiency symptoms

a) Plant nutrients: are chemical elements that are taken up with the soil water by the roots and serve as promoters of various vital life processes in the plant organism like photosynthesis, cell division, flowering, fruiting, etc.. According to the quantity required by the plants they can be grouped into primary nutrients (nitrogen, phosphorus, potassium), secondary nutrients (calcium, magnesium, sulphur) and micro-nutrients or trace elements (iron, copper, zinc, manganese, boron, chlorine, molybdenum, cobalt).

- Nitrogen, among other functions, is part of the chlorophyll, of proteins and nucleic acids. It has a strong influence on vegetative growth.

Where the supply of nitrogen is insufficient, plants become dwarfed and stunted with leaves of light green or yellowish color (without darker veins). However, too much available nitrogen in the soil delays the maturing and hardening of the tissues. The plants remain soft and succulent and become susceptible to diseases.

- Phosphorus is responsible for flowering and fruiting, which absolutely depend on it. Viable seeds cannot develop without the presence of phosphorus. It also encourages root growth, particularly the development of lateral and fibrous rootlets, and increases the general resistance of the plant against diseases.

Lack of phosphorus results in grey-green to bluish-green spots and blotches on the leaves of broadleaved species. The needles of conifers remain short and are of red-violet color. Flowering and the development of fruits and seeds will be unsatisfactory.

- Potassium increases the plumpness of seed kernels, regulates the water content of the plant tissues and increases resistance against drought.

Potassium deficiency becomes obvious when the leaves of seedlings look dry and scorched along the margins. Pine needles start drying from the tip.

- Calcium is important for the moderation of acidic soil reactions. The symptoms of calcium deficiency are very complex, because soils lacking calcium are usually acidic at the same time. This in turn makes many nutrients except iron and manganese unavailable to plants. Too much calcium results in an alkaline reaction, which is equally unfavorable, because it will cause a shortage of phosphorus and many trace elements.

- Magnesium is a central component of the chlorophyll. Its deficiency in broadleaved species can be detected when yellow spots appear all over the leaf, while green seams remain along the veins. The needles of coniferous species turn yellowish from the tips.

- Iron promotes respiration and the formation of chlorophyll. Shortage in available iron turns leaves and needles yellow with the ribs and veins remaining green up to the finest ramification, which resembles much the deficiency signs typical for magnesium.

- b) Measures in case of deficiency symptoms: Although a nutrient deficiency can be latent without obvious symptoms, it will usually be noticed when the seedlings remain stunted and their leaves are discolored. These hunger symptoms should not be mistaken for diseases (18).

The first thing to do is to check the pH value. If the soil turns out to be very acid or alkaline, the shortage may be

due to the fact that certain nutrients, though present in the soil, are not available for the plant. In that case only the pH value need to be changed.

If, inspite of an accurate soil reaction, the seedlings continue to show deficiency signs, one has to find out which element is most urgently needed. However, identifying discolorations of the leaves may be difficult, when symptoms typical for the deficiency of one specific nutrient are superimposed by other signs of malnutrition. Since the lacking element is sometimes hard to determine, one could try a compost dressing or a careful application of<sup>a</sup> complete fertilizer as a kind of trial-and-error method.

However, the cost of fertilizer application can be cut down by applying more pointedly only the actually missing elements. To be able to choose the type of<sup>a</sup> single or mixed fertilizer that exactly meets the nutrient requirements, it is recommended to have a sample of the nursery soil tested at the Soil Laboratory of the Bureau of Forest Development in Manila. The soil test shows the distribution of the mineral soil particles according to size, determines the pH value and reveals which nutrients are needed for optimum growth.

- c) Taking soil samples for analysis: The soil sample should represent the average conditions of the nursery. If one part of the nursery differs markedly from the rest in the characteristics of its soil, it will be advisable to take a separate sample.

For fairly uniform nurseries a composite soil sample may represent best the average conditions. With a spade a V-shaped cut with a depth of about 20 cm is dug and a slice about 2 cm thick is taken. The edges of the slice are trimmed with a knife on both sides of the spade blade, so that a strip of soil about 2 cm wide is left. From a mixture of 10-20 such samples collected at random over the whole nursery area about 500 grams are taken for analysis.

## 9.8 Commercial fertilizers

Application of commercial fertilizer replaces mainly the three primary nutrients: nitrogen, phosphorus and potassium. There are also special fertilizers that contain micro-nutrients (21,27).

The kind and amount of nutrient element in fertilizers is shown in the analysis printed on the fertilizer bag. The first figure indicates the percentage (by weight) of nitrogen available in the fertilizer, whereas the second and third figure show the percentages of phosphorus and potassium respectively.

While the figure for nitrogen indicates exactly the proportion by weight of the pure element N, there are two ways of expressing the content of phosphorus and potassium (21). Formerly the contents of P and K were expressed only as phosphorus pentoxide  $P_2O_5$  and potassium oxide  $K_2O$ . But nowadays, it has been frequently practiced to use also for these nutrients figures that indicate the relative amount of the pure elements. The conversion factor from percent  $P_2O_5$  to P is 0.44, that for changing percent  $K_2O$  into K is 0.83. For example a 12-24-12 fertilizer according to the old designation (N- $P_2O_5$ - $K_2O$ ) would be called now 12-10.5-10. It is usually printed on the fertilizer bag which designation is used.

Fertilizers should be stored in a dry room. Some fertilizers such as nitrates and urea are hygroscopic. They attract moisture, especially under the humid conditions of the tropics, which causes the fertilizer to dissolve. To keep the fertilizer bags dry they should be placed on a wooden platform made of scantlings or thick boards.

a) Nitrogen fertilizers: The following types are commonly sold:

|                   |                |        |
|-------------------|----------------|--------|
| Sodium nitrate    | $NaNO_3$       | 16 % N |
| Ammonium sulphate | $(NH_4)_2SO_4$ | 21 % N |
| Ammonium nitrate  | $NH_4NO_3$     | 33 % N |
| Calcium nitrate   | $Ca(NO_3)_2$   | 15 % N |
| Urea              | $CO(NH_4)_2$   | 45 % N |

Nitrogen is taken up by plants in the form of ammonium ( $NH_4$ ), but more often as nitrate ( $NO_3$ ). The ammonium ion is absorbed

by humus and clay particles, whereas the nitrate ion moves with the water and is easily leached. Ammonium is converted continuously by soil bacteria into nitrate.

If nitrogen is urgently needed by the seedlings, one should apply a fertilizer containing nitrate, like sodium nitrate, ammonium nitrate or calcium nitrate as a top dressing. They are given in small doses to avoid losses through leaching. Ammonium fertilizers like ammonium sulfate and urea supply nitrogen for a longer period. Ammonium sulfate and urea increase the soil acidity, sodium nitrate and calcium nitrate reduce it. Nitrogen fertilizers can be applied as a surface dressing because they dissolve easily and are then carried down into the root zone.

Generally, one should be careful not to over-fertilize the seedlings with nitrogen. The result would be weak and succulent plants susceptible to diseases. No nitrogen fertilizer should be applied later than two months before field planting.

b) Phosphorus fertilizers: The following types are available:

|                       |                          |                       |
|-----------------------|--------------------------|-----------------------|
| Single superphosphate | $Ca(H_2PO_4)_2 + CaSO_4$ | 16-20 % $P_2O_5$      |
| Triple superphosphate | $Ca(H_2PO_4)_2$          | 46 % $P_2O_5$         |
| Basic slag            |                          | 16-20 % $P_2O_5$      |
| Ammophos              | $NH_4H_2PO_4$            | 48 % $P_2O_5$ + 11% N |

Phosphorus is absorbed by the plants in much smaller quantities than nitrogen and potassium. Often very little of this element is present in the soil in a form that is available to plants. In very acidic or alkaline soils phosphorus becomes part of chemical compounds that cannot be dissolved. The most suitable soil reaction for the absorption of phosphorus is the range between pH 6 and 6.5.

Contrary to nitrogen, phosphorus is tightly held by clay particles and cannot be leached out. If phosphorus is applied as a surface dressing, it may be fixed there without reaching the root zone, where it is actually needed. Phosphorus fertilizers should therefore be worked into the soil of nursery beds or mixed with the potting soil before sowing or transplanting.

c) Potassium fertilizers: The following types are available:

|                             |                    |                      |
|-----------------------------|--------------------|----------------------|
| Potassium sulfate           | $K_2SO_4$          | contains 50 % $K_2O$ |
| Sulphate of potash-magnesia | $K_2SO_4 + MgSO_4$ | 25 % $K_2O$          |
| Potassium chloride          | KCl                | 60 % $K_2O$          |
| Potassium nitrate           | $K_2NO_3$          | 44 % $K_2O$          |

Potassium is not as easily leached as nitrate, but also not as tenaciously absorbed as phosphate. Potassium fertilizers should therefore be applied more or less the same way as phosphates. High concentrations of potassium fertilizers near roots or seeds can cause damage.

Potassium chloride must be applied several weeks before sowing or transplanting, so that the harmful chloride ion will be leached already when the planting or sowing starts.

d) Mixed and complete fertilizers

One has the choice of using complete fertilizers of many different formulas. The different compositions have been prepared to suit the nutrient requirements of agricultural crops like vegetables or rice. Common formulas (according to the N-P<sub>2</sub>O<sub>5</sub>-K<sub>2</sub>O analysis) are 16-20-0, 12-24-12, 14-14-14, 12-12-12, 10-5-20, 5-20-5, 5-10-16. For forestry purposes generally fertilizers are recommended with a relatively large proportion of phosphorus.

Mixed and complete fertilizers are manufactured to facilitate fertilizer application where two or all three primary nutrients are deficient. They are more expensive than the single nutrient fertilizers. The convenience of applying complete fertilizers should not lead to their indiscriminate use without investigating what nutrients are actually needed.

Complete fertilizers should not be broadcast over the land, but worked into the root zone. Potting soil can be enriched with 30-50 grams of a complete fertilizer for every 10 liters.

One could produce one's own complete fertilizer by mixing single nutrient fertilizers in the form of pellets in desired proportions. But care must be taken not to bring ammonium fertilizers together with fertilizers containing lime to avoid losses of

nitrogen, which would escape as gaseous ammonia. Superphosphates should not be put together with lime, as the phosphates would combine with the lime to form insoluble compounds. Hygroscopic fertilizers like nitrates and urea are mixed only shortly before use, as they tend to form lumps.

e) Calcium fertilizers

Lime is the common calcium fertilizer. We can distinguish three types: ground limestone, burned lime and slaked lime.

- Ground limestone is the most widely used lime fertilizer. It is available as calcium carbonate  $CaCO_3$  or dolomite  $CaMg(CO_3)_2$ . Ground limestone is mild and not caustic.
- Burned lime or calcium oxide  $CaO$ : By subjecting limestone to considerable heat in a kiln the calcium carbonate is converted into calcium oxide, which is rather caustic.
- Slaked lime or calcium hydroxide  $Ca(OH)_2$  is produced by adding water to burned lime. It is caustic and unpleasant to handle.

Since ground limestone, especially in the dolomitic form, dissolves but slowly in the soil, it is important that only finely pulverized limestone with improved solubility is used. Calcium carbonate is mild; it can be worked into the soil shortly before planting or sowing without any adverse effects on seeds or seedlings.

The neutralizing effect of burned and slaked lime is higher than that of ground limestone. However, because of their caustic properties, these two kinds of lime are generally more preferred in the preparation of compost.

With lime the pH value of acidic soils can be easily raised. However, it should be applied with caution. It is necessary to check the soil reaction with a pH-meter before and after application. A relatively higher amount of lime is required for well buffered soils with a high humus content to achieve the desired change. There is always the danger of overliming. Never should the pH value be raised, above 6.5.

Apart from "liming" we can supply the soil with calcium by using single nutrient fertilizers which in addition to the primary nutrient also contain calcium, like calcium nitrate or basic slag.

- f) Magnesium fertilizers: The more acidic the soil, the less magnesium is available to the plants. The use of dolomitic limestone, which contains both lime and magnesium, can correct a magnesium deficiency as well as raise the pH value of the soil. Magnesium can also be added in the form of a special magnesium fertilizer such as sulphate of magnesia or sulphate of potash-magnesia.
- g) Sulphur fertilizers: Sulphur can be provided in sufficient quantities together with the primary nutrients by using one of the following fertilizers: ammonium sulphate (23 % S), superphosphate (12 % S) or potassium sulphate (18 % S). The use of elemental sulphur (flower of sulphur) with its acid forming properties is recommended when sulfur is needed in soils with too high a pH value.
- h) Fertilizers supplying micronutrients: are ferrous sulphate (iron), copper sulphate, zinc sulphate, borax (boron), sodium molybdate (molybdenum) and muriate of potash (chlorine); furthermore so-called chelates, which are complex organic compounds of iron, zinc, manganese and copper.

Trace elements should be only applied after the pH value has been checked and corrected. In alkaline soils many micronutrients (iron, manganese, copper, zinc, boron) would become unavailable to plants.

The mentioned fertilizers are either worked into the soil or dissolved in water and sprayed onto the leaves. Since only very little of the micronutrient is needed, small quantities of the chemical will cause already satisfactory results. The limits between deficiency and excess are rather narrow.

## 9.9 Preparation of compost

- a) Compost, as a humus fertilizer, not only improves the physical soil properties and stimulates the activity of the soil organisms, but also adds all the nutrient elements needed by the plants in balanced quantities (9).

Since under tropical conditions humus mineralizes at a fast rate, it has to be replaced from time to time. It is a great advantage, that compost need not to be bought in the market like commercial fertilizers, but can be produced in the nursery without much cost by using mainly organic waste materials. In rare cases bat guano, another excellent humus fertilizer, can be obtained from caves in the vicinity of reforestation projects.

Compost is well decomposed organic matter of all kinds (grasses, weeds, waterhyacinths, sunflowers, rice straw, rice hull, vegetable remains, kitchen wastes, sawdust; forest litter like twigs, leaves, needles, chopped left-over seedlings; farm manure) (20).

- Weeds and grasses used for compost production should not bear seed, because not all weed seeds lose their germinative capacity during the decomposition process.
- Farm manure is probably the most valuable raw material for the preparation of compost. If no farm, corral, or slaughter house are nearby, one should try to gather carabao or cattle droppings from the fields or grazing areas.  
  
The bulk of farm manure derives from cattle. Cattle manure is very mild, because the fodder has been chewed twice and digested in the long intestinal tract of the cattle into very fine particles. Although of lesser qualities, the manures of horses, pigs and chicken are very valuable too. Never should fresh farm manure be used in the nursery. Before use, it should be decomposed in a compost pile.
- Woody materials such as fine twigs, sawdust and chopped left-over seedlings yield a very good humus. But these substances decompose slowly due to their high lignin content.

b) In piling up the organic material good garden soil rich in microbes has to be added in little amounts to inoculate the pile with soil organisms. Compost piles are usually set up in layers. For example: a layer of organic mass is spread about 30 cm thick on the ground and covered by 2-5 cm of good garden soil, which is followed by another layer of organic material, and so forth. The quality of the compost can be increased by partly using farm manure. Sawdust should not be set up in layers, but mixed thoroughly with fine good soil or chicken manure to hasten its decomposition.

Since in the first phase of decomposition much oxygen is needed by the microorganisms, the compost materials should be piled up loosely with ample air space in between. For the same reason the pile should be only moist inside, not wet. An indication that the decomposition ("burning") process is going on properly, is the generation of considerable heat (about 40-50°C) in the compost pile soon after it has been set up.

c) Additives to hasten decomposition: Apart from oxygen the soil organisms consume nitrogen. To hasten their activities nitrogen can be added in the form of manure and wastes of the meat market or slaughterhouse. If such materials are not available, commercial nitrogen fertilizers like calcium nitrate or ammonium sulfate should be sparsely dispersed over each layer of organic material.

During the process of decomposition organic acids are set free, which in turn may affect the microbes. These acids can be neutralized by adding some lime (slaked lime  $\text{Ca(OH)}_2$  or calcium carbonate  $\text{CaCO}_3$ ) to the compost layers. To prevent nitrogen losses care must be taken, that lime and nitrogen containing ingredients including manure are not placed together.

Ashes (derived from wood, rice straw, etc.) are a valuable admixture to the compost pile, because they contain many plant nutrients and trace elements, and also counteract acids.

d) Compost pile: The organic materials can be set up on level ground as compost pile with a trapezoidal cross section. The length of the pile may be 3-10 m, its height 1.00 - 1.30 m. The pile is covered thinly with good soil and a grass mulch on top and sides. Wide bamboo tubes with pierced internodes can be placed along the center of the pile to provide additional aeration.

e) Compost pit: It is not advisable to dig a compost pit, because it easily gets filled with water during the rainy season. Furthermore, aeration in a pit is poor, and it is difficult to manipulate the materials when the compost is to be tended. A shallow pit, however, is a useful place where the daily organic wastes can be dumped until enough material has accumulated to set up the real pile. But this pit must not be used for general garbage disposal (e.g., tin cans, bottles, plastic material, etc.).

f) Compost compartments: A good method for compost making is to build several compartments (1.00 to 1.20 m high, 1.00 to 1.50 m long) made of hollow-blocks, preserved boards, inter-linked wire netting or bamboo poles. There should be some space between the hollow-blocks or boards to allow aeration.

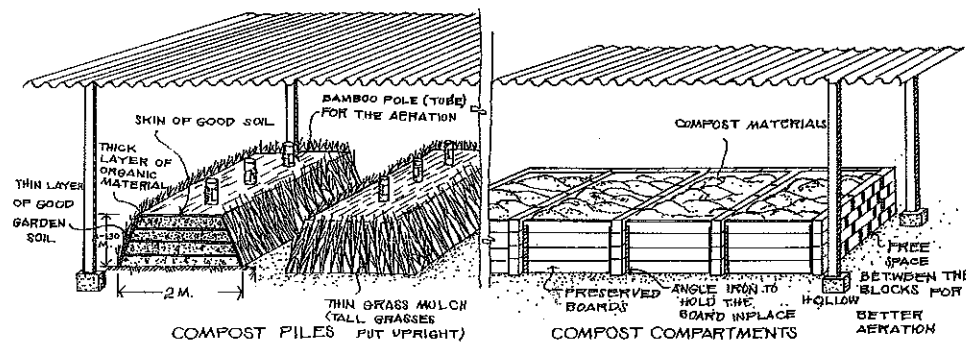

Fig. 52: Compost piles and compost compartments

The compartments should be constructed near a driveway, so that the materials can be brought in by vehicle. The front-side consists of preserved boards, which are held in place by two angle irons attached to each side of the wall. The boards can easily be removed when the compost is to be turned, or when it is ready for use.

In operating such a "compost plant" the first compartment is filled with organic material. When the first stage of decomposition is over (after 1-2 months) the partly decomposed material is transferred to the second compartment, and the first is refilled again. This is repeated until the compost is ripe for use.

- g) Treatment of compost: The compost pile has to be well tended, if the final product is to become good compost. The materials have to be loosened, mixed and re-piled two to four times at intervals of 3-6 months depending on the kind of organic substances and the climatic conditions. The right tool for working the pile is the manure fork. The compost pile is stirred the first time about three months after it has been set up to allow fresh oxygen to get into it.

Another important point is to control the moisture inside the pile. During all stages of ripening the compost should be slightly moist, but neither dry nor saturated with water as this interferes with the activity of the microbes. It is therefore recommended to erect a roof (cogon, palm leaves, corrugated iron sheet) over the pile to protect it from heavy rainfall and intensive sun. A favorable moisture content can then be maintained by sprinkling the pile from time to time.

#### 9.10 Green manuring

Green manuring implies working of undecomposed green plant tissue into the soil to enrich it with humus and nitrogen. An ideal green manuring plant should produce a large quantity of organic mass in a short time, and that on poor soil. Legumes are generally preferred because of their nitrogen fixing abilities (27). The green manuring plant should be resistant against fungus attack and damage from excessive rainfall (7,27,33).

It is difficult to find a crop species with all those desirable characteristics. Under lowland conditions one should try mungo bean (*Phaseolus aureus*), soybean (*Glycine mas*), tapilan (*Phaseolus calcaratus*), cowpea (*Vigna sinensis*), kudzu (*Pueraria phaseoloides*) and *Crotolaria juncea*. All these species have been tried already in the Philippines with varying success for the improvement of agricultural land. *Lupinus* spp. and horsebeans might be suitable for higher elevations above 1000 m .

30 to 60 kg of seed per hectare (depending on the species) is broadcast over well prepared land and worked into the soil at a shallow depth with a rake or harrow. On newly opened land or where legumes have not yet been grown, the inoculation of the seed with nitrogen-fixing bacteria may be necessary. Broadcasting of soil from a field with legumes would serve the same purpose.

One has to be cautious in choosing the right season for sowing green manuring crops. The end of the rainy season with still occasional rainfalls seems to be the most suitable sowing time.

If the soil to be improved is very poor in nutrients, an application of about 50 kg per hectare of a complete fertilizer is recommended right after sowing. The treatment may be repeated one month later if necessary.

Just before flowering, the green manuring plants are cut and plowed or dug under. A small part of the area is saved for the production of seed to be used in further soil improvements.



PREVENTION AND CONTROL OF PESTS AND DISEASES

10.1 Introduction

Reforestation programs can be successfully carried through only, if the tree seedlings raised in the nursery are robust and healthy. Diseased or weakened seedlings having suffered under the attack of various pests are hardly in a condition to overcome the hazards of the planting site.

Unfortunately, the warm and humid climate of the tropics is rather favorable for the development of pests and diseases. Insects can quickly build up huge populations during warm and dry periods, when the favorable climatic conditions favor a rapid sequence of short life cycles. During the rainy season the high relative atmospheric humidity provides excellent conditions for fungus diseases. Rains and high temperatures often shorten the effectiveness of pesticides, so that repeated treatments may become necessary.

Apart from that, nurseries with their artificial ecological balance (wide bed areas planted densely with seedlings of just one species and of uniform size) offer per se favorable conditions for pests. This is particularly true for the greenhouse, which in addition keeps out atmospheric factors (e.g. rain) that could check pest populations.

Thus, the control of pests and diseases in the nursery is an important, sometimes cumbersome task, which requires attentiveness and responsibility on the part of the personnel.

10.2 Methods of plant protection

Destructive agents can be fended off or exterminated by mechanical, chemical or biological control measures (16).

- a) Mechanical and physical protection measures: For a long time mechanical devices and techniques, and heat were the only means known to kill pests. This included: collecting beetles and caterpillars from the leaves and needles by hand; squashing insect eggs, leaf rollers, aphids between fingers; heating and steam-sterilizing of soil; catching rodents with traps; covering seedbeds with a frame of mosquito wire mesh to keep out rodents, birds and insects.
- b) Plant protection with chemicals: Between 1930 and 1940 plant protection experienced a real breakthrough when the insecticidal properties of DDT and HCH (Lindane) were discovered. From this turning point, intensive research work led to the synthesis of a number of highly effective chemicals like the organic fungicides (Ferbam, Zineb, Maneb, Captan) and insecticides composed of organophosphorus compounds (Malathion, Mevinphos, Basudin, Metasystox, Dipterex) or carbamates (Mipcin). Plant protection seemed to be no problem anymore.

However, after some time, when the impact and long term consequences of repeated pesticide application became fully evident, the formerly so optimistic view about chemical plant protection had to be revised. While the new fungicides as a whole turned out to be rather unpoisonous and and unproblematic (except the mercury compounds), there are unfavorable side effects with almost all insecticides (16).

Many insecticides are extremely poisonous to humans (e.g. Parathion, Endrin, Phosdrin) as well as to domestic animals, game and bees. These chemicals also wipe out beneficial parasites and predators, which as the natural enemies of the pests help to keep their populations at low levels.

The persistent chlorinated hydrocarbons (DDT, Lindane) have an adverse effect on the ecology, because they will not disintegrate under normal atmospheric and biotic conditions.

DDT is taken up through the nutrient cycle and accumulated in the fat tissues of humans, mammals and fish. The prolonged use of the same chemical has also often resulted in resistant strains of pests.

Yet, we are not in a position to protect our nurseries completely without chemical pest control. Whenever there is a massive attack of pests or a disease spreading rapidly over the beds, we can prevent further damage only by using pesticides. The loss of seedlings, that would occur otherwise, cannot be afforded.

Plant pathologists are trying nowadays to discover new pesticides that are less toxic to humans, show a somewhat selective action and exterminate otherwise resistant species. There are now special acaricides like Thiovit, which are effective against spiders and mites but harmless to insects and nontoxic to humans. The active ingredients Metasystox (Bayer) or Dimethoate, also called systemic insecticides, are quickly absorbed through the roots and leaves, thus remaining toxic only to sucking insects like aphids. Insecticides with the active ingredient DDVP (Bayer-Dedevap, Shell-Maladrin) quickly disintegrate after application, so that beneficial parasites after hatching will not be affected any more. Malathion (Esso) is a similar chemical compound as Endrin or Parathion and equally effective, but less poisonous to humans. Bayrusil (Bayer) claims to be effective against otherwise resistant pest species. Pyrethrum, an extract of the flower of *Chrysanthemum cinerariaefolium* has a rapid knock-down effect on aphids and chewing insects, but is of low toxicity for mammals. Besides, it quickly disintegrates after application.

Except for seed dressing, soil fumigation or sterilization and the prophylactic spraying of insecticides in the greenhouse at regular intervals, one should not apply pesticides without considering, whether there is any pest to be killed at all. Control measures should be initiated only, if some pests or diseases pose an actual threat. Observe the damage level. It might not always be necessary to apply radical pesticides against pests that have a low population density or whose damages have no economical consequences.

c) Biological pest control: The endeavor in finding out new insecticides not poisonous to mammals and with selective action bore fruit, when scientists tried to make use of the natural enemies of insects like predators, parasites or diseases. Particularly the artificial dissemination of insect pathogens like polyhedral viruses, bacterioses and mycoses that selectively eliminate certain pest species proved to be successful. Such a biological preparation is for example Thuricide (Shell) composed of *Bacillus thuringiensis*.

### 10.3 Preventive measures

By employing preventive measures it is often possible to avert the spreading of diseases and the occurrence or build-up of pest populations, and thereby avoid expensive control operations.

For the outbreak of a pest a combination of three factors must be present: an infective pathogen, a favorable environment, and a susceptible plant (1). When we keep the nursery clean, take prophylactic control measures and raise robust, vigorous, well nourished but hardy seedlings, we create conditions that are not favorable for pest development.

a) Cleanliness in the nursery: Mortalities among seedlings have to be constantly removed. If death was caused by diseases the infected plants should be burned. Seedlings perished because of physiological disorders and weeds are deposited in compost piles.

All kinds of garbage, trash and rubbish, broken pieces of glass, old tin cans, paper and plastic materials are thrown into the garbage pit, which is dug somewhere at the edge of the nursery compound.

Especially in the greenhouse cleanliness is a necessity. As a prophylactic control measure it is advisable to spray its interior with an insecticide (e.g. Malathion, Bayrusil, Thiodan, Basudin) at four-week intervals concentrating on

the hiding places of cockroaches and other pests. For the same reason no soil should be used in the greenhouse, that has not been sterilized.

Seed of species susceptible to damping off can be soaked in disinfectant solutions (merthiolate, formaldehyde) to kill harmful organisms on the seed surface, or they are treated with a dressing of organic mercury compounds combined with an insecticide (e.g. Bayer-Ceresan). A fungicide against damping off can be added to the water into which the seed-boxes are to be dipped.

Plants to be brought into the greenhouse have to be carefully inspected for diseased parts or pest infestation. The mosquito wire mesh, which usually makes up the upper portion of the greenhouse side walls, has always to be intact.

b) Avoiding conditions that favor diseases: The growth of disease pathogens is promoted by high air humidity combined with lacking air circulation. Such conditions are found in too densely sown seedbeds or in transplant beds where the seedlings were spaced too narrowly. Heavy shading for a longer period should be avoided, because it reduces air circulation. Limited growth space and lack of sunlight also weaken the plant and soften its tissues rendering it more susceptible to diseases. Watering in the late afternoon increases air humidity during the night, particularly at the stem base near the ground. A soil reaction above pH 7, as well as an overdose of nitrogen or an application of manure that is not well rotten will promote the occurrence of damping off diseases.

c) Production of vigorous plants: Usually one can see from its outer appearance, whether a plant thrives well or suffers under deficiencies or maltreatment. The common physiological disorders that indicate injury or disturbed functions of the plant organism and at the same time reveal inadequate nursery techniques are listed below (1). These symptoms should not be mistaken for diseases.

- Sunscald: Grey blotches, which later turn whitish, dry out and become brown and brittle. They can appear on leaves of transplanted seedlings when rainy and cloudy weather is abruptly followed by a hot, bright spell, or when shades have been removed too suddenly without transition.
- Etiolation: Small pallid green leaves, slender elongated stem; plants have a tendency to lodging; caused by over-shading.
- Wilting: A temporary shortage of soil moisture causes leaves and shoots to lose their turgidity, to become flabby and droop. In serious cases they do not recover but dry up.
- Aphyxiation (oxygen deficiency) of the roots: Unhealthy looking, pale green leaves caused by excessive watering, e.g. when floodbeds remain permanently flooded for several weeks. The fibrous roots decay, toxic substances may appear in the root zone through the activity of anaerobic microorganisms.
- Soft, succulent shoots and leaves: usually caused by an overdose of nitrogen.
- Chlorosis and signs of malnutrition: See Chapter 9.7 .
- Twisted or deformed shoots of dicotyledonous plants can be an indication of careless use of weedkillers. After the application of herbicides sprayers should be cleaned thoroughly with activated charcoal.

Such malfunctions of vital plant organs weaken the whole plant organism and render it highly susceptible to the attack of pathogens and pests. It is beyond question that these manifestations of inadequate nursery practices must be remedied at once.

d) Early detection of diseases and pest attack: Pests and diseases can be detected in their early stages of development only by constant observation and alertness. The man in charge has to check the plants in his nursery daily on abnormalities, malformations or discolorations. It is not enough to have occasionally an overall look over green nursery beds. Instead, seedlings growing in different parts of the nursery have to be closely examined. Only through this practice one can detect diseases and pests before they spread or build up to dangerous dimensions.

This daily inspection is particularly important with newly germinated delicate seedlings, because the time lapse between the first signs of the disease and its devastating spread over the whole bed area is usually very short. With tiny seedlings it is sometimes difficult to detect insect damage. The minute stem which is usually left over by the insect, can hardly be recognized with the naked eye. Much damage may have been caused when the gradual disappearance of seedlings finally becomes obvious.

#### 10.4 Names, terms and groups of chemical pesticides

A vast variety of agricultural chemicals for pest control is offered in the market nowadays. Every year new brand names and active ingredients appear and will be advertised. The following terms serve to group and classify these chemicals and provide clues on their composition and action (12).

- a) Pesticide is the general term for all chemicals that kill or suppress harmful plant or animal organisms. We can distinguish the following groups: fungicides, nematocides, acaricides (against spiders and mites), insecticides, rodenticides, molluscicides (against snails and slugs), bird repellents, herbicides.
- b) Brand or trade names: The different pesticide manufacturers are turning out products which may contain all exactly the same active ingredient, but have different trade names. For example, Dithane M-22 (Rohm & Haas), Plantineb 80 (Hoechst), Manebio (Union Sales), Maneb 80 % (Bayer) and Polyram M (BASF), all these fungicides have the same active ingredient: Maneb.
- c) Active ingredient: This is the effective component in a pesticidal preparation. The active ingredients are mostly complex chemical compounds with scientific names too complicated for practical use. They are therefore commonly known by short names or abbreviations. For example: the chemical compound dichlorodiphenyldichloroethane is known DDT, or, zincethylenebisdithiocarbamate as Zineb. The active ingredient and its concentration are shown on the label of the pesticide container.

d) Pesticide formulations: Pesticides are sold in either solid or liquid form. We can distinguish the following formulations:

- Emulsifiable concentrate (E.C.): The active ingredient is part of an oily liquid, which additionally contains an emulsifying agent. It is emulsified in water and usually applied as spray. Insecticides formulated this way are generally rather poisonous to humans because of the high concentration of the active ingredient.
  - Wettable powder (W.P.): The pesticide is formulated as a fine powder to be mixed with water and to be applied as a spray. It contains wetting and dispersing agents, so that the minute particles will disperse and suspend well. Wettable powders are safer for tender foliage than the emulsifiable concentrates and pose less hazards to the persons applying them.
  - Dust: With this ready for use formulation the active compound is mixed with finely ground talc or clay (concentration 1 - 2.5%); application with dusters.
  - Granules are a practical formulation for soil treatments; application by hand.
- e) Spray additives or adjuvants (stickers and spreaders): are added to pesticide sprays to improve their effectiveness and to prevent wastage. Often the marketed products already contain both components.
- A sticker will cause the spray particles to adhere better to the surface of leaves and needles, so that they will not be washed off too quickly by rain or irrigation water.
  - A spreader (dilutant, wetting agent, detergent) is recommended, when leaves or needles with hairy or waxy surfaces and plants infected with mildew are to be treated especially with wettable powder formulations. The wetting agent prevents the formation of droplets that hesitate to spread and tend to roll off. Instead, it causes the spray to spread readily over the leaf surfaces covering them with a uniform film.

A rather comprehensive list of pesticides available in the Philippines with their active ingredients, trade names, formulations and indications is supplied in the appendix of this chapter.

## 10.5 Application of pesticides

### 10.5.1 Seed Treatment:

As a preventive measure seed can be treated immediately before it is sown to avoid damages and losses that might be caused later by fungi, soil insects, rodents and birds.

To eliminate harmful organisms on the seed surface the seed can be soaked in solutions of Merthiolate or Chlorox (sodium hypochloride). Immersing the seed in 0.1 % Formaldehyde ( $\frac{1}{2}$  - 1 teaspoon of 40 % Formaldehyde to 1 liter of water) would also kill whatever germs exist inside the seed (15).

More effective are treatments that provide a protective coating. Suitable chemicals are mixed with the seed lot at the prescribed rate as dust, liquid (add sticker) or as a special slurry preparation (thick suspension). The slurry treatment generally gives the best results. To provide effective protection the coating must be sufficiently thick. The chemical will diffuse into the soil and disinfect a zone around the seed, in which germination and early growth can take place undisturbed.

The chemical and, if required, a sticker is added to a small quantity of seed which has been placed in a container. The receptacle is shaken until the coating is satisfactory. For large quantities of seed it is useful to employ rotating barrels (tumblers) or cement mixing machines.

Very effective chemicals for the treatment of seed before sowing are the organo-mercury compounds (Ceresan, Semesan, Tillex). Their use can, however, become hazardous to the seeds as well as to the user, if they are not applied with

utmost care. Useful non-mercuric fungicides are Ferbam, Thiram, Chloranil, PCNB (Brassicol, Terrachlor), Captan. If the attack of soil insects (termites) seems likely, one of the following insecticides can be added to the dressing: Lindane, Heptachlor, Aldrin, Dieldrin. Ready fungicide-insecticide preparations are also commercially available. Bird repellents like minium or red lead, Morkit and Anthraquinone have been successfully used in the US for protecting pine seeds from birds.

### 10.5.2 Soil fumigation:

This is another prophylactic technique, which is mainly applied in open nursery beds and eliminates adverse soil organisms such as soil fungi, nematodes, soil insects, weed seeds and rhizomes in one single operation. Whether formulated as gas, liquid or granules, soil fumigants disintegrate soon after application and produce toxic fumes that penetrate the soil killing all living organisms present.

Soil fumigants are not cheap (except Shell D-D), and in the isolated reforestation projects it may be difficult to obtain them. Often their application is rather complicated, since provisions have to be made that the toxic fumes will not escape from the soil prematurely, but on the other hand, no trace of the usually phytotoxic fumigant will be left when the treated bed is to be sown or planted. Some of the chemicals (particularly Chloropicrin and Methylbromide) are extremely poisonous to humans. This explains why soil fumigation as a rule should only be carried out by specially trained personnel observing elaborate precaution measures (11,35,42).

Small quantities of soil for seedboxes and greenhouse benches should generally be disinfected by steam sterilization only (see chapter 10.7).

### 10.5.3 Soil drenching:

Soil is soaked or wetted with a pesticidal liquid to control damping-off diseases, soil insects and termites. It should be slightly moist when the treatment is started.

Usually the chemical solution is distributed evenly over the area to be treated at a rate of 2-4 liters per m<sup>2</sup> by using a sprinkling can with a rose at its spout. With delicate seedlings a sprayer would be more suitable.

As a prophylactic measure against damping-off, fungicides like Captan (Orthocide 50), Dexon, PCNB (Brassicol, Terrachlor) or organo-mercury compounds (Ceresan, Agallol) are sprinkled over the bed shortly before sowing followed by another application 10-15 days later. The same technique with shorter intervals is applied when the seedlings show already signs of the disease. The mercury-based fungicides have to be applied cautiously, since their continuous use may result in soil poisoning.

Lindane, Chlordane (only pre-planting treatment), Heptachlor, Aldrin, and Dieldrin are suitable chemicals against soil insects and termites. After application the soil is worked 10 to 20 cm deep. The usual concentration is 2-5 tablespoons per 5 gallon can. Termites require about ½ liter Chlordane, Dieldrex 15 or Aldrex 2 per 5 gallon can and a drenching rate of about 4 liters per square meter.

To control soil insects in transplant beds the insecticidal liquid can also be poured directly out of the spout of a sprinkling can (without rose) into 3 cm deep furrows along the rows of seedlings at the rate of approximately 0.5 liters per meter.

Another possibility to get rid of soil insects is to produce holes (3 cm diameter, 10-15 cm deep) with a wooden peg at regular intervals of 20 cm on the bed surface, into which the liquid is poured at a rate of 150 cc per hole.

#### 10.5.4 Spraying:

Most insecticides and fungicides are applied by sprayers. We can distinguish between air blast sprayers and hydraulic pressure sprayers (23,29).

- a) Air blast sprayers: utilize a high velocity air stream or blast to break up the liquid into very fine mistlike droplets (0.05 - 0.15 mm) and to blow them towards the affected

plant. Examples of this type are the "flitgun" and the motor-powered knapsacksprayer.

- "Flitgun": This is probably the simplest spraying instrument. It is cheap and practical in the greenhouse, but too small and not effective enough for the nursery. By operating its piston air pump an air blast is produced, which at the same time injects some spray liquid from the reservoir into the air stream either inside or outside the pump cylinder.
- Motorpowered knapsacksprayer: The motor propels a fan that produces a strong air stream (velocity 120 m/ sec), which blows into the open through a relatively wide flexible rubber hose. The chemical flows from the tank through an adjustable valve and enters the air stream at the mouth of the rubber hose.

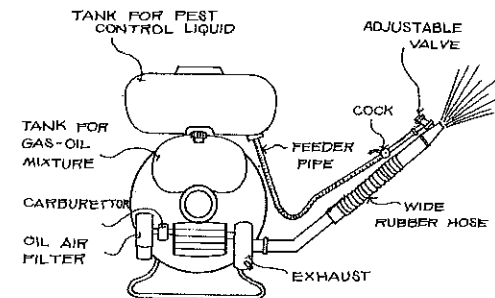
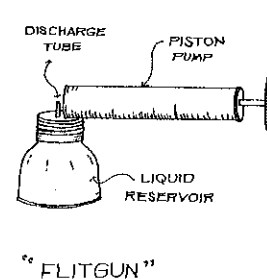

MOTOR-POWERED KNAPSACK SPRAYER

Fig. 52: Flitgun and motorpowered knapsacksprayer, both operate according to the principle of air blast sprayers

This way of pesticide application is also called concentrate or low volume spraying, because much less water is needed (only about 1/10) as compared to hydraulic sprayers. Since the amount of pesticide remains the same, a ten times higher concentration will be obtained. Advantages: reduced water requirements, speeding up of spraying operations, less wastage of pesticides. However, the motorpowered knapsacksprayer can be recommended only for large nurseries.

b) Hydraulic pressure sprayers: The spray liquid is forced with pressure through a nozzle, which breaks it up into fine droplets. These droplets are larger than the fine mist produced by the air blast sprayers. Since relatively much water is needed, this technique is also called "thorough coverage" or high volume spraying. It is the "normal" way of spray application and all recommendations of the producers on the labels of pesticide packages concerning spray liquid concentrations refer to this method.

In the average reforestation project hand-operated pressure sprayers, especially the knapsack sprayers, are the most useful spraying implements. They are relatively inexpensive, easy to operate and to maintain, but nevertheless fully meet the needs of the project. Apart from pest control, they are often employed for other purposes like watering delicate seedlings or applying wood preservatives. Some common models are listed below:

- Bucket sprayer with double action plunger pump: The feeder pipe is either connected with a shoulder-carried plastic container, or its suction end, to which a strainer has been fastened, is placed in a bucket containing the spray liquid. This model is useful for the greenhouse and for small nurseries.

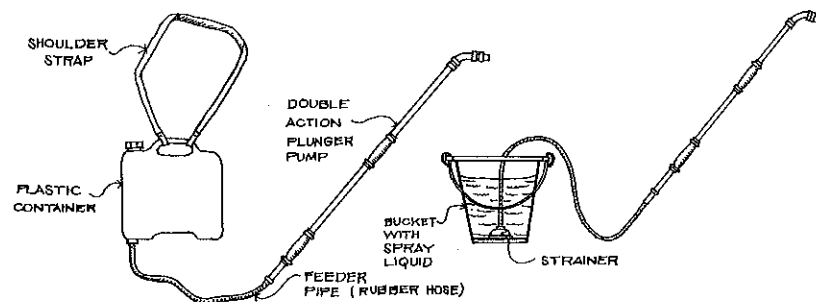

Fig. 53: Double action plunger pump

- Automatic compression sprayer: There are shoulder-carried and back-carried models. Before this type of sprayer can be operated one has to produce the required working-pressure of approx. 70 lbs per square inch by pumping air with a built-in air piston pump into the interior of the tank.

With this type of sprayer no pressure must be produced anymore during the spraying operation. The tank is filled up only to one half of its volume, the rest is reserved for compressed air. There is a red mark on the tank wall indicating the upper limit of the liquid level. Essential accessories on top of the sprayer are a safety valve and a manometer showing the highest admissible working pressure. The spray is controlled by pressing down and releasing the lever of a trigger control cock, which is mounted between rubber hose and spray tube.

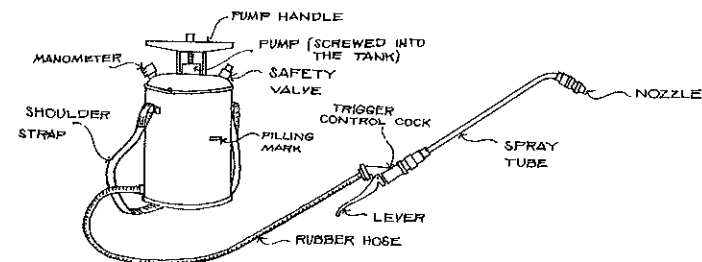

Fig. 54: Compression sprayer

Compression sprayers are useful in the greenhouse and in small nurseries. However they are relatively expensive, heavy, inconvenient to carry and have a relatively small filling volume.

Hand-operated knapsack sprayers: The necessary working pressure is produced during the spraying operation by moving a pump lever, which is either mounted overhead or

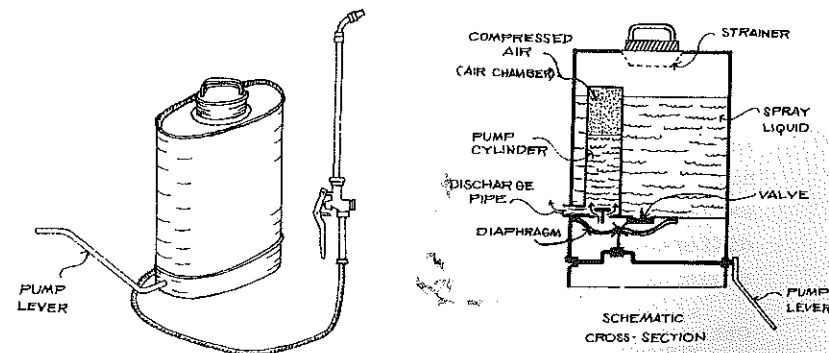

Fig. 55: Knapsack sprayer with diaphragm pump (Adapted from Lambrecht, 1967)

protrudes from the bottom of the tank. As illustrated in fig. 55 and 56 the available models are either equipped with a diaphragm pump or with a piston pump.

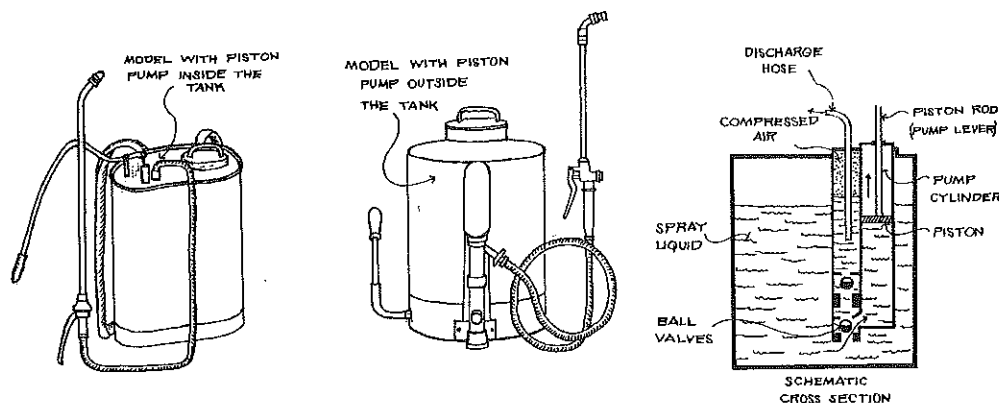

Fig. 56: Knapsack sprayers with piston pumps (Adapted from Lambrecht, 1967)

Both are useful and practical sprayers for the average type of reforestation nursery. Preferred are light weight models made of plastic and aluminium with a tank volume of 10 - 15 liters and an operational pressure<sup>of</sup> 50 - 80 psi.

c) Nozzles are always found at the tip of the spray tube of hydraulic pressure sprayers. They have the task to transform the spray liquid into fine droplets and to uniformly distribute them. The higher the working pressure, the finer the size of the droplets.

The most widely employed nozzle type for pest control purposes is the swirl spray nozzle. The spray is formed by propelling the liquid through the screw threads of a whirling pin before it is forced through a small hole in the nozzle cap into the open. A more sophisticated design has exchangeable whirlpins and orifice disks with holes of different sizes, so that droplet size, delivery and the angle at the top of the spray cone can be modified.

Other types of nozzles are the impact nozzle, where a high velocity jet strikes a smooth surface, and the flat fan nozzle (Teejet, Fanjet), where an oblong orifice produces a fanlike spray (useful for herbicide application). -

d) Preparation of spray solution:

- Containers and liquid measures needed:

kerosene can (5 gallons = 19 liters) - or better - plastic pail with marks indicating the liters; one liter tin can; small 40 cc measuring cup (plastic) with 10 cc graduation, obtainable from pesticide dealers, if not available tablespoon and teaspoon.

- Concentration of the spray liquid should be strictly in accordance with the prescriptions of the manufacturer. There is also often a note on the label concerning the compatibility of the chemical with other pesticides, i.e. usually whether insecticide and fungicide can be sprayed together in one operation.

- Use of wettable powders: To avoid the formation of lumps first some water is added to the measured quantity of wettable powder in a small container. Water and powder are agitated with a small wooden stick until they become a thin paste, which is then stirred into the required amount of water in a pail or kerosene can. Only clean water should be used to prevent the nozzle from clogging.

A spray liquid prepared from wettable powder is a suspension. The tiny solid particles of the powder do not dissolve in water, but remain suspended for some time and then slowly sink to the bottom of the container. The spray liquid has therefore to be agitated from time to time, if not used up immediately after preparation.

- Use of emulsifiable concentrates: The required volume of E.C. is simply stirred into the needed amount of water. The spray liquid, an emulsion, has a milky appearance.

- Addition of stickers and spreaders: Where the spray liquid remains in droplets on waxy, hairy or powdery leaf surfaces, a spreader should be added, so that a good coverage is obtained. The dosage recommended is generally 1 teaspoon per 5 gallon can, for low volume sprays more. To find out the correct dosage one has to observe the pattern of the spray deposit.



During rainy periods it is advisable to add a sticker to prevent fast wash-off. Recommended are usually 3 table-spoons per kerosene can.

- e) Application of spray: All affected parts of the plant should be thoroughly covered. Direct the spray also upward to hit the underside of the foliage.

To make sure that the spray residuals will remain on the leaf surface for some time one should take care, that the seedlings to be treated are dry, and that spraying is carried out well ahead of a bad weather front to allow the spray to dry up before the rains start.

On the other hand, spraying emulsifiable concentrates during the hot hours of the day should be avoided because of increased danger that delicate leaves may get damaged, and that the operator is harmed by the inhalation of poisonous fumes.

- f) Maintenance of spraying equipment: After use sprayers should be thoroughly cleaned. Use warm water together with some Tide or another detergent. Rinse the sprayer repeatedly with warm water and pump it empty to flush out whatever dirt water and corrosive spray materials might be left. Then, all valves are opened for draining, the sprayer is dried inside and outside with a rag and turned upside down, so that any remaining water will either drain or evaporate. When the sprayer is likely not to be used for a longer time grease or oil all metal parts and valve balls, but refrain from doing so with plastic or rubber materials (38).

#### 10.5.5 Application of dusts and granules

- a) Dusting equipment: The simplest dusting implement consists of a tin can with fine holes in the bottom, or of a nylon stocking pulled over an open tin.

More effective are small hand dusters. An air blast produced by operating an air piston pump or by squeezing rubber bellows passes the dust container and emits the raised

dust cloud through a small flared nozzle. The models depicted in fig. 57 are available at Pharmaceutical Industries, Zuellig Bldg., Buendia Ave., Makati.

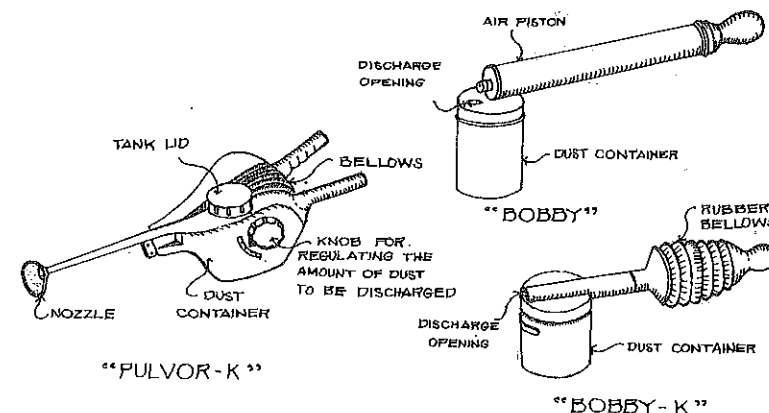

Fig. 57: Hand dusters (Fa. Birchmeier)

A further improvement is the blower duster. Here the dust cloud is blown out of the duster nozzle by a continuous air stream generated through a built-in hand-rotated fan.

The knapsack motorduster is basically the same implement as the knapsack motorsprayer, which with some additional exchangeable accessories can be quickly turned into a motorduster. Rarely needed in the forest nursery, but perhaps useful in plantations in regions where water supply is scarce.

- b) Dusting the foliage of affected seedlings: Compared to spraying, dusting has some disadvantages. Because of the sensitivity of the dust particles to wind and their quick being washed off the leaf surfaces by rain, it is only possible where fair weather conditions constantly prevail. Besides, the dust particles have very little adhesive properties, so that in any case the treatment will have to be repeated after a short time. Dust formulations to be applied on foliage generally contain only 1-2.5 % of the active ingredient and are relatively expensive because of the high proportions of carrier material needed. However, where water supply is a problem, dusting is a practical way of pesticide application, since dust is a ready-to-use material.

Only a limited number of pesticides are available in low concentrate dust formulations. Examples: Kelthane dust (against mites), Elosal and Thiovit (against powdery mildew and mites), Dipterex Dust 2.5 % and Baygon Dust 1 % (against chewing insects and ants).

It is advisable to dust in the morning, when there is little air movement and when the foliage is still damp (but not wet) to ensure a better adherence of the dust particles.

- c) Soil treatment with dust and granules against damping-off diseases, nematodes or soil insects: Over the soil to be treated pesticide granules are strewn with a spoon by hand, or, dust concentrates (D.C.) or wetttable powders (W.P.) dispersed with a dusting implement. The applied chemical is then worked into the upper soil layer around as deep as the seedlings' roots extend.

Some suitable chemicals for this kind of soil treatment are Agallol, Brassicol, Terrachlor, Orthocide 50 (all W.P.) against damping-off; Agrocide 65 W.P., Heptachlor 25 % W.P., Aldrin 40 % D.C., Thiodan granules against soil insects; Nemacur P granules and Terracur 5 % granules against nematodes, soil insects and sucking insects; Disyston 5 % granules against soil insects and sucking insects.

#### 10.6 Precautions when handling pesticides

Pesticides are poisons. They have been developed to kill either harmful animals or destructive plant life. Unfortunately, in most cases the poison is not only effective against the organisms it has been intended for, but also hazardous against other living beings. If carelessly applied, pesticides can damage the cultivated plants they are supposed to protect (tree seedlings), affect domestic (dogs, chicken, pigs, cattle) and other useful animals (bees, fish) and, above all, endanger man.

Thus, unsuitable high concentrations of mercury compounds and Dexon used as seed dressings can impair the viability of seed, let alone their high mammal toxicity. Emulsifiable

concentrates can cause leaf burn, especially if applied during the hot hours of the day. Most nematocides are also phytotoxic; a safety period has to be observed before anything can be sown or planted. Persistent organochlorine compounds like DDT and Endrin imperil grazing cattle and goats. Rat poison baits would like-wise cause the death of dogs and pigs. Since bees are insects too, most insecticides will kill them. Minor quantities of Endrin, Endosulfan, Heptachlor or Captan led into rivers or ponds will already be sufficient to exterminate whole fish populations.

Some of the materials are extremely poisonous or otherwise detrimental to humans and are likely to be fatal if swallowed, inhaled or absorbed through the skin. Because of their high toxicity insecticides with the active ingredients DDT, Endrin, Parathion (E605), Methylparathion, Azinphosmethyl (Gusathion), EPN, Demeton (Metasystox) and Phosdrin should not be used any more in reforestation nurseries. The nematocides (soil fumigants) Chloropicrin, Methylbromide, D-D, EDB should be applied only by specially trained personnel.

Although, as a whole, the other commonly used pesticides listed in the appendix are somewhat less toxic to mammals than the above-mentioned chemicals, one has to be by no means less careful in their application. Each new formulation undergoes rigid testing before it is produced in large amounts and sold to the public. The findings are recorded on the package label, which should be meticulously read before a pesticide is bought or used. The label usually informs on the chemical's composition, the percentage of active ingredient it contains, crop species to be protected and the respective pests that can be controlled, the adequate spray concentrations and techniques of application; it also contains warnings, precaution measures and recommendations for the physician in case of poisoning (e.g. the administering of antidotes).

There is no need to stress, that the directions for use on the label should be conscientiously followed. Two transgressions are quite common. First, when preparing the spray

solution the philosophy: "little is good, more is better" leads to higher concentrations than permitted and probably to damage and injury, at least to waste of money and materials. Secondly, the notion, that the warnings and recommended precaution measures are likely to be highly exaggerated.

Whenever pesticides are handled observe the following general precaution rules (16):

- Avoid to wet the bare skin (hands) with the spray solution, but under no circumstances should there be any contact with the liquid concentrates of insecticides. Especially Lindane BHC, Aldrin, Dieldrin, Diazinon would be quickly absorbed through the skin.
- When working with pesticides it is generally recommended to wear a hat and protective denim or cotton clothing. It should cover the whole body and fit tightly around neck and wrists. The hands should be protected by putting on leather or rubber gloves. Slippers are no adequate footwear. Use instead canvas basketball-shoes or rubber boots. As additional protection against pesticide sprays, it is advisable to generally wear goggles and a face mask, even if the label actually does not call for it.
- Do not smoke (eat, drink) and chew (chewing gum) while applying pesticides.
- Spray or dust in the morning or late afternoon. Avoid the hot hours of the day.
- Always spray in the same direction as the air current (moving forward with the current or backward against the current). Do not spray on windy days. See to it, that no other persons are hit by the spray drift.
- After work has been finished, clean sprayer and mixing containers thoroughly. Any leftover amount of the spray liquid should not be kept in some container, but poured into a hole dug in the ground in a place where it will not contaminate rivers, ponds or the ground water. Never throw empty containers or surplus pesticides into riverbeds or ponds. Change and wash the protective clothing. Wash hands and face with soap in running water; better take a bath.
- Empty carton packages have to be burned (keep away from the smoke), pesticides bottles broken and cans crushed, so that they can never be used any more for other purposes. The broken remnants of the containers have to be safely disposed and buried in the garbage pit.
- Pesticides must be kept in their original package. All pesticides are stored under lock and key away from food

or fodder in a special room or cabinet with ventilation openings (or the door of the cabinet is covered with fine wire screen). The forester in charge himself should be the one holding the key.

- If the spray solution or the liquid concentrate are spilled: remove and wash contaminated cloth under running water; cover the polluted portions on the ground with soil.
- If spray or concentrate comes into contact with the skin or eyes: wash the affected parts of the body immediately with soap under running water. Rinse eyes with clear water at least for 5 minutes, and get medical attention as soon as possible.
- If the pesticide is swallowed (children): Instantly call a doctor and try to induce vomiting by introducing a finger deep into the throat of the victim. Administer a tablespoon of salt dissolved in a glass of warm water. Repeat until the vomit fluid is clear and the pesticide cannot be smelled any more. But never give anything per mouth to an unconscious person. Have the patient lie down and keep quiet.
- If symptoms of poisoning, such as dizziness, headache, fatigue, nausea, vomiting, tightness of chest, blurred vision, excessive salivation and sweating, watering of the eyes, constriction of the pupils become evident during or after pesticide application, immediately stop working and call a physician or rush the patient to a hospital.
- When medical help is called for: show the doctor the original pesticide package. Usually the label contains some hints, what kinds of antidotes (atropine, barbiturates, vitamins) should be applied.

#### 10.7 Steam-sterilization of soil

A practical way to sterilize a portion of soil is to allow hot steam for a certain time to pass through it.

This principle can be implemented by converting an empty gasoline drum into a steam sterilizing apparatus (4). A removable wooden flooring with 20 cm legs is fitted inside the drum to hold the soil mixture in place over a level of water 10-15 cm deep. The flooring has a number of holes (7-10 mm), which are covered with some kind of sacking, that no soil may clog them, but the steam can nevertheless pass. A piece of one inch pipe reaching from just below the rim of the drum to the bottom with a tightly fitting stopper at its top is built in to be able to replenish water, should all the water have evaporated during the sterilizing process.

The drum is placed over a hearth improvised from bricks or hollow-blocks, and filled with the topsoil /humus /sand mixture. The fill should not be compacted, so that the steam can easily penetrate. Finally, a wooden or metal cover is placed on top of the drum. After a fire has been lit under the drum the water starts boiling, and the hot steam generated will penetrate through the soil.

This steam penetration should go on for about one hour. After that, all harmful soil organisms will have been exterminated provided the steam maintained a temperature of about 80° C. Higher temperatures and a longer sterilization time can have unfavorable side effects, particularly with soil mixtures containing partly decomposed organic matter. Due to the quick breakdown of organic substances they can lead to an adverse oversupply of nitrogen and micro-nutrients (esp. manganese) and to the formation of toxic compounds (HARTMANN and KESTER, 1968).

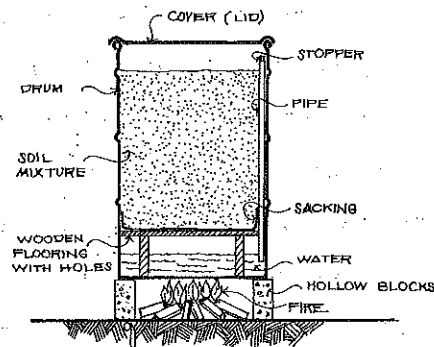

Fig. 58: Cross section through steam-sterilizing apparatus

Another possibility is to heat the soil in open vats or on galvanized iron sheets over a fire. But only a small quantity of soil can be treated this way at a time. A less effective method is to just pour hot water over the soil to be treated.

## 10.8 Some common pests and diseases

### 10.8.1 Diseases

Occuring on nursery plants can be caused by fungi, bacteria or viruses (1).

- Fungi are small plants lacking chlorophyll and conductive tissues. While most of them live on dead organic material, some are parasitic by nature depending solely or partly on the living tissues of a host plant. The body of the fungus is called mycelium, the branches or filaments of the mycelium are called hyphae. Fungi reproduce by means of spores. The majority of diseases in the nursery are caused by fungi.
- Bacteria are very small microscopic plants consisting of single cells. They invade the vessels of the host plant, where they multiply and spread. Under moist, warm conditions this process can be very rapid.
- Viruses are submicroscopic entities with the properties of chemical molecules, which cause disturbances in the normal functions of the cell (1). They multiply by inducing host cells to form more viruses. Virus diseases are very hard to control. Fortunately they constitute no problem in the nursery.

- a) Diseases on roots and stems: Radicles and hypocotyls of germinating seed as well as the roots and stems of young tree seedlings can be infected by a variety of different soil borne fungi (e.g. Rhizoctonia, Pythium, Fusarium, Botrytis). The symptoms caused by the fungi are quite similar in appearance and are known as root rot, stem rot, but more generally as damping off. In the pre-emergence type of the disease the radicle is already attacked as soon as it develops, the seedling will thus be killed before it appears at all. Usually the seedling emerges, but shortly after, roots and stem become discolored, soft, water-soaked, black and brown with the stem base constricted (wire stem). Since the mushy, girdled stem base cannot support the crown any more, the seedling will fall over on the soil, wither and die.

Particularly susceptible to damping-off are germinating seeds and young seedlings of tree species like Benguet pine, agoho, bottlebrush, Eucalyptus, kaatoan bangkal and seedlings of similarly delicate nature.

With damping-off it is particularly important to observe preventive measures. High air humidity around the seedlings is avoided by not sowing too densely, by thinning of dense sowings, correct spacing of transplants, keeping the beds free from weeds, using only half shade; watering in the morning, so that the bed surface can dry up till evening. Good soil drainage is essential too. The soil reaction should range between pH 5 and pH 6. Do not fertilize with lime or commercial fertilizers that raise the pH value, and with compost, which is not completely rotten (decomposed). Be careful with nitrogen fertilization to avoid the development of succulent tissues. Harden the seedlings by exposing them to full sunlight as soon as possible. In full sunlight fungi cannot thrive because of the prevalence of detrimental UV-rays. Because of these reasons rather sow Benguet pine in the open than under shelter.

Recommendable are also prophylactic measures like soil sterilization through heat (see 10.7), soil fumigation (see 10.5.2), drenching the soil with suitable fungicides (see 10.5.3), soaking of seed in a disinfectant solution or dressing seed with a protective coating (see 10.5.4), watering seedboxes in basins where fungicides like Orthocide 50 (Captan) or Brassicol (PCNB) have been added. Steam sterilization should be the rule where soils are to be used in the greenhouse.

It is relatively difficult to control the disease once it has occurred. The usual treatment consists of sprinkling the soil of seedbeds repeatedly with a fungicide solution or dusting it with suitable wetttable powders (10.5.5).

b) Diseases on leaves and shoots can be easily detected through typical discolorations and malformations. Common infections are:

- Powdery mildew: (Peronospora, Oidium): Leaves and shoots are covered with a white powdery mycelium. The infected leaves become brown and dry.

- Downy mildew (Peronospora, Phytophthora): starts with pale, yellow, chlorotic spots on the upper surface of the leaves, which later become greyish to dark brown. Simultaneously a downy greyish-blackish mildew mycelium develops on the corresponding area on the lower surface.
- Rust (Melampsora, Uromyces, Puccinia): These fungi need alternate host plants to fulfill their life cycle. They produce small pustules on the underside of leaves and pine needles, which rupture to release red, brown, orange or yellow spores. On the upper leaf surface the pustules are marked by small reddish circular spots. Stems and needles can also show rusty lesions.
- Grey mould (Botrytis): On the leaves appear soft, rotten patches with grey masses of spores.
- Dieback (Colletotrichum, Corticium): The shoots and branches of seedlings begin to shrivel and dry up from the tips downward.
- Leaf blight, leaf rot (various fungi and bacteria): General rapid browning of leaves and branches.
- Leaf spot, blotch, scab (Cercospora, Alternaria, Cladosporium): On the leaves appear irregularly shaped dark brown or black spots sometimes with a distinct yellow edge. The spots enlarge to patches, until finally the leaves wither and drop.
- Needle cast of pine species (Lophodermium et al.): Small, black, elongated or rounded fruiting bodies appear as spots on the needles. Later the needles turn red or brown and drop. Only the newly emerging needles of the shoot will be left on the seedling.

To lessen the danger of infection one should avoid shady, damp conditions in nursery beds with no air circulation, as well as the overfertilization of seedlings with nitrogen.

Most of the mentioned diseases on shoots and leaves (needles) can be controlled by copper fungicides or by the new organic fungicides with the active ingredients Ferbam, Maneb, Zineb, and by Captan and Difolatan. Sulfur formulations (Elosal, Thiovit) and Dinocap (Karathane) have been specifically developed against powdery mildew. Copper fungicides have been found to give the relatively best results against leaf blight or wilt caused by bacteria.

### 10.8.2 Nematodes

Besides bacteria and fungi there are other organisms of microscopical size that can injure seedlings, but which belong to the animal kingdom, the nematodes or "eelworms" (1). They are minute (ranging in size from 0.3 mm. to 2 mm.), slender, transparent worms, usually not visible without using a magnifying glass. Their mouth parts have the form of a stylet (an Italian dagger, where the slender blade springs out from the handle and automatically snaps into position), with which they pierce and puncture the cell walls of living or dead plant tissues.

Most nematodes are harmless and help to break down organic matter. Some however are dangerous plant parasites attacking roots, stems or foliage. Apart from the mechanical injury there are secretions released from the mouth, which often cause malformations and swellings. Nematode infested seedlings are likely to become additionally afflicted with diseases. Parasitic nematodes are generally polyphagous, i.e., they feed on a variety of plant species.

In the forest nursery, especially the root-infesting species can become troublesome. Root systems showing the following symptoms are usually infested with nematodes (1):

- Root knots or root galls: Swells, thickened sections and malformations of the roots are caused by the root-knot nematode (*Meloidogyne*; the female is typically pear-shaped). In 1968 Glori and Postrado found, that 97% of six months old kaatoan bangkal seedlings sampled at random at the Montalban Reforestation Experimental Nursery were heavily infested with this parasite.
- Short, stubby root branches: without the usual hair rootlets are caused by the stubby-root nematodes (*Trichodorus*). Attacked root tips stop growing but swell and enlarge in size. Frequently, affected roots produce numerous lateral roots (excessive root branching), which in turn will again be attacked by the nematodes.
- Root lesions: Discolored and often collapsed portions of roots are caused by the lesion nematodes (*Pratylenchus*), which live and feed within the roots. Together with them, secondary fungi and bacteria will help in the complete breakdown of whole parts of the root system.

The above-ground symptoms of root nematode infestations are not so typical. The plants lack vigour and remain stunted, leaves are reduced in size and show signs of nutrient deficiency (chlorosis, yellowing); excessive leaf drop, wilting and dieback will occur during dry spells.

Nematodes are hardy pests, which are not so easy to control. It is doubtful, whether a rotation of tree species can keep the population down, since nematodes usually do not have any choice species. Flooding nursery beds for several weeks or months before sowing or transplanting will kill the nematodes by depriving them of air. Soil to be used for seedboxes and greenhouse benches is usually steam-sterilized (see 10.7). Nursery beds in the open can be fumigated (see 10.5.2). Most nematocides, except those on organophosphorus basis like Nemacur P and Terracur P, are however toxic to plants, so that they can only be applied to uncultivated soil.

### 10.8.3 Mites

Belong to the spider-class (Arachnida), which like the insect-class (Hexapoda) is part of the phylum Arthropoda of the animal kingdom (29). They have four pairs of legs, no antennae, jaws or eyes, nor any body segment. Because of their small size, they are hard to detect. Some are so minute, that a magnifying glass is needed. The spider mites or red spiders are visible on the leaves as small, sometimes translucent specks of yellowish, reddish or brownish color often rapidly moving under a fine web usually on the underside, where they are sheltered together with their eggs and larvae. Mites suck and extract the chlorophyll from the leaves.

Infested foliage becomes tipped with silvery pale green or yellowish spots. From short distance it has the appearance of being covered with dust. Frequently the edges of the leaves curl. Later the whole leaf becomes silvery, reddish or bronze. Many of the injured leaves drop.

Mites became dangerous pests, especially in fruit orchards, after the widespread use of persistent chlorinated hydro-

carbons like DDT, which used to kill all their natural insect enemies. Mites can be controlled by systemic acting insecticides consisting of organo-phosphorus compounds like Malathion, Diazinon (Basudin), Demeton (Metasystox), Disyston, as well as by special acaricides.

#### 10.8.4 Insects

About 72% of all animals on earth belong to the insect class. They possess 3 pairs of legs, 3 body regions (head, thorax or chest, abdomen) and 1 or 2 pairs of wings which enable them to fly. With some species, especially of the sucking types, the wings, body segments and legs are entirely missing or have been reduced to very small size. Most insects undergo a metamorphosis. They start as egg, from which a larva or nymph hatches. The larva ends up as pupa, out of which the adult insect or imago emerges, while the nymph gradually becomes bigger until it has reached the final adult stage (29).

According to their habits and the peculiarities of the inflicted damage insect pests occurring in the forest nursery can be arranged into the following groups (16):

a) Sucking insects belong to the orders Thysanoptera (Thrips), Homoptera (jassids, psyllids, aphids, whiteflies, scale insects, mealy bugs) and Hemiptera (bugs). They injure nursery plants by piercing the cuticula and sucking the sap, often from the underside of the leaves. The upper surface becomes spittled with silvery, yellow spots. After an obvious deformation the whole leaf finally turns yellow and drops. Most of the following species also spread plant viruses:

- Thrips are minute slender insects with their wings fringed with long hairs.
- Leafhoppers (jassids): size more or less 6mm, wedge-shaped, often brilliantly colored, very actively flying and jumping. The nymphs lack wings, are very small, pale and hard to detect.

- Psyllids: size 3 mm, brown, yellow or black, two short antennae in front of the eyes, resemble leafhoppers.

- Aphids are small soft-bodied insects of green, yellow, brown or black color with a pair of secreting tubes at the end of the abdomen. They cluster in colonies along young shoots, flower buds or on the underside of the foliage. Ants nurture them for the honeydew they excrete.

- Whiteflies are tiny (1 mm) four-winged insects with powdery-white body and wings. The nymphs, which do not move, are surrounded by a fringe of white waxy material.

- Scale insects: The legless, wingless and eyeless females are covered with a hard waxy shell, beneath which they live and suck sap. The males look like tiny midges. A scale insect infestation becomes obvious by a sooty mould over stems and foliage due to honeydew excretion.

- Mealy bugs: small permanently mobile insects dusted all over with white wax down. They live in colonies along the midribs and at leaf and stem joints.

- Stink bugs, leaf bugs, lace bugs: small to medium sized (6-29 mm) flattened insects of various colors. On their basal half the front wings are thick and stiffened, the other half is abruptly thinner and overlapping when folded back.

Sucking insects can be best controlled by applying systemic insecticides (Metasystox, Disyston). Endosulfan (Thiodan, Endox), Diazinon (Basudin), Malathion, Bayrusil and Sevin are similarly effective.

b) Free living chewing insects feed on leaves and shoots of nursery plants. They can easily be detected. This group comprises grasshoppers and locusts (Orthoptera), beetles and weevils (Coleoptera) as well as the larva of butterflies, moths (Lepidoptera) and sawflies (Hymenoptera).

- Beetles and weevils: are well sclerotized insects of different sizes and colors (The size ranges from the tiny flea beetle over medium-sized Japanese and leaf beetles up to some big May beetles and weevils) with strong, hard forewings and membranous hindwings. Weevils have prolonged snoutlike mouthparts. Unlike moths and butterflies the adults eat plant substances. Their larvae, which often feed on roots or live in plant tissues (stems, leaves), are known as grubs.

- Butterflies, moths, sawflies: do not harm plants. It is the larva, that causes the damage. The larvae are commonly known as caterpillars (especially the hairy larvae of the butterflies), defoliators, skeletonizers, leafworms, cutworms



(the naked varieties; the greyish, brownish kinds hide in the soil during the day and attack voraciously at night), loopers (characteristic way of moving, because their center legs are missing), armyworms (march in columns from plant to plant) or hornworms (large larvae with a slender horn projecting from the rear end).

Nowadays, all these pests can be easily controlled with the various effective insecticides available in the local markets (see appendix), notably

- against grasshoppers and locusts: Lindane, Chlordane, Heptachlor, Aldrin;
- against beetles and weevils: Lindane, Aldrin, Dieldrin, Endosulfan (Thiodan, Endox), Diazinon (Basudin), Malathion, Dipterex, DDVP, Zectran (Baygon), Sevin (Vetox 85);
- against caterpillars: same as beetles; additionally Thuricide, Dipel.

c) Leafrollers, leaf tiers, webworms: Some small leafworms and caterpillars do not move freely in the open, but wrap leaves around themselves (leafrollers) or tie leaves and shoots together for shelter (leaf tiers), which at the same time also provides food. For the same reason webworms build a dense protective nestlike web around the infested foliage with each web containing a number of worms.

Due to the protective coverings these pests cannot be directly hit by insecticide sprays. Useful are therefore insecticides that either produce toxic vapors passing through the tyings and webs like HCH (Lindane) and DDVP (Dedevap, Maladrin) or those having a long lasting residual effect, such as Aldrin, Dieldrin, Malathion, Leybacid 50, Baygon, Sevin (Vetox 85), apart from the systemic formulations on the basis of Demeton (Metasystox), Di-Syston and Methomyl.

d) Leaf miners, borers, gall insects are even better protected from poisonous sprays, because they live and feed inside the plant. They are best controlled by systemic insecticides or those with a certain systemic action like Malathion and Basudin. Their economical significance in the Philippines is not great, though.

e) Soil inhabiting insects: There are insects that spend a portion of their life cycles in the soil, where they may cause damage to the roots of seedlings.

- Cutworms are hairless greyish or brownish larvae of certain moths, which hide in the ground during the day and feed on roots, leaves and shoots during the night (Noctuidae). Cutworms got their name, because they often cut off young seedlings at the base and eat them up. The short erect leftover stem of the seedling can be detected only by close examination. When touched the worms curl up immediately.
- Grubs: This term is applied to the larvae of the May beetles and June bugs (Scarabaeidae). They have a white body with a brown head and 6 prominent legs, and can reach a length of 4 cm. The hind part is smooth and shiny with dark body contents showing through the skin. The larvae of certain weevils (Curculionidae) are also white with a brown head, but smaller and without legs. All grubs feed on roots.
- Rootworms: whitish, slender, cylindrical worms, 3-9 mm long, with tiny legs and brownish heads. As larva of the leaf beetles (Chrysomelidae) they feed on roots and tunnel through roots and stems.
- Wireworms are the destructive larvae of the click-beetles (Elateridae), which have the ability to snap into the air when placed on their back. The worms are hard, dark brown, smooth and wire-like, and vary in length from 12-40 mm.

Soil inhabiting insects are more difficult to detect and to control than the free living species. Soil to be used in the greenhouse should generally be sterilized to eradicate any existing soil insects. Since this is not possible in open nursery beds, seedlings have to be carefully observed instead. If attack is suspected, some seedlings should be uprooted to check their roots and the surrounding soil.

Suitable insecticides against soil inhabiting insects are those, that produce poisonous fumes, such as Lindane, Chlordane, Heptachlor, Aldrin, Dieldrin. They are applied either as a soil drench or in form of pellets or dust. To avoid all those above-mentioned organo-chlorine compounds, Bayer developed a most promising soil insecticide in granule form: Terracur P, which is an organo-phosphorus compound. Cutworms, which also feed above-ground, can additionally be controlled by spraying Malathion, Endosulfan, Diazinon, Leybacid or Sevin.



f) Ants, termites, cockroaches, powder post beetles: These insects are rarely attacking any tree seedlings, but can become a nuisance and cause considerable damage in nursery buildings, in which timber and bamboo have been used, as well as in storage rooms, greenhouses and storage sheds.

- Ants: (Ord. Hymenoptera, Fam. Formicidae) live in colonies with distinct social castes. Generally noticed are the wingless workers, which are all sterile females. They forage for food and take care of the queens. The queens (the egg-laying females) together with the eggs, the helpless maggot-like young and the pupae remain in the underground nest. At certain times winged males and females are produced, which will swarm and form a new colony. After mating the males die.

Apart from being a nuisance because of their painful bites, many ant species attack tender, newly germinated seedlings or attend to aphids, mealy bugs or scale insects to obtain sweet honeydew, of which they are fond of. They thus promote the build-up and spreading of populations of these sucking insects.

Ants can be controlled by dusting or spraying the paths and infested areas with Aldrin, Dieldrin, Chlordane, Heptachlor or Baygon. A better method is to locate the nest by following the line of foraging workers back to the place, from where they are coming, and intoxicate it with a strong insecticidal liquid. Once the queen is dead, all other forms will also perish. If the nest cannot be located, one can also place poison baits (Baygon baits or baits made of bran and Diptorex) in the pathway. Slow acting insecticides are preferred, so that the ants will carry the baits to their nest and feed the queen and the young with them.

Termites: (Ord. Isoptera) are small to medium-sized yellowish or whitish insects, in the Philippines known as "white ants" or "anay". Termites differ from true ants in not having a slender waist. Their pattern of social organization, however, is similar, as there is a queen, which lays the eggs, a male (king) and numerous workers and soldiers. Contrary to the ants there are only three development stages: eggs, nymphs and adults.

Among the different termites the soil-inhabiting (subterranean) species can become particularly troublesome. Their nest is always found in the ground, no external mounds are erected. Places aboveground, where the workers carry out their destructive

activities are connected through burrows and runways with the nest. Termites gnaw wooden materials from the inside forming long tunnels and galleries. Because of their hidden way of living the destruction can remain undetected for quite a time.

Termite control aims at breaking the contact between the termite colony in the soil and the timber structure and woodwork of the building. Houseposts should be placed on concrete foundations, which should surpass the ground level by about 30 to 40 cm. A thin sheet of metal (galvanized iron) between foundation and timber provides some additional protection by definitely preventing any secret connections.

In case of termite attack, but also as prophylactic measure, the soil around the foundations is made impassable by drenching it with Chlordane, Aldrin, Dieldrin and Heptachlor with concentrations recommended by the manufacturer. Infested wood is painted with oily emulsions containing the mentioned termiticides, or, these liquids as well as dust formulations are injected into holes drilled into the inhabited area. Termite control will become difficult and more expensive, once the pests have established themselves in the building.

- Powder post beetles (Fam. Ptinidae, Lyctidae, Anobiidae; in the Philippines called "bokbok") are small, brownish, elongate, hard-shelled beetles, which lay their eggs in the pores of wood. The larvae, small white grubs with a big head, mine the wood and pack their tunnels with fine flour-like powder. After pupation the adult beetles eat their way to the surface making "shot-holes".

Powder post beetles are dangerous destroyers of woody materials and structures, such as stored boards and lumber, seedboxes, boho pots, shading mats. They reveal themselves through the shotholes and the woodpowder ejected from there, usually after considerable damage has been caused already.

Infested wood can be treated (brushed) with an emulsion of Chlordane and deodorized kerosene. Shading mats will be protected from infestation, if they are sprayed with Chlordane, Heptachlor, Diazinon, Leybacid or Baygon prior to the long times of storage during the rainy season.

- Cockroaches: (Ord. Orthoptera, Fam. Blattidae) These brownish-black or tan, shiny, flat-bodied, beetle-like insects,

which are mainly active at night, are well known to everybody. They can become a nuisance in storage rooms and in the greenhouse. Scrupulous cleanliness combined with prophylactic sprayings of Chlordane, Malathion, Diazinon, and putting Baygon baits in the hiding places, will keep them at bay.

#### 10.8.5 Snails and slugs (Gastropoda)

Are soft-bodied, gray, legless, slimy, slow moving animals with a length usually ranging from 1 to 5 cm (some are bigger). While moving a sticky slime is secreted from their bodies, which on drying becomes visible as silvery shining trails marking the course where the creatures have crawled (30).

- Snails, among them the destructive Japanese snail, carry a coil-shaped, calcareous shell on their back, into which they disappear during the day or when danger seems imminent.
- Slugs, do not possess such a housing.

During the day snails and slugs hide in damp places, in the greenhouse preferably under plant refuse, waste of all kinds, decaying wood, under flower pots and wooden seedboxes piled under the greenhouse bench, in the open under leaves, lumps of earth and stones. In the evening they leave these hiding places to feed during the night on shoots and leaves of broadleaved species. They often become rampant during the rainy season.

One should avoid potential hiding places by keeping the nursery, particularly the greenhouse, clean and tidy. Flowerpots, seedboxes, and other supplies should not be placed under the greenhouse bench but on shelves and racks. Plant wastes are dumped at the compost place, inorganic rubbish thrown into the garbage pit. Small populations of slugs can be kept at a low level by trapping them under plant refuse and handpick them in the morning. Snails are simply picked from the ground as their houses can be easily discerned.

The application of (metaldehyde) baits is the adequate countermeasure against heavy infestations. Snail pellets can be broadcasted over the entire area at the rate of about 20-30 pellets per square meter, or, if snails or slugs invade the nursery bed regularly at night from the outside, they can be distributed in strips along the border lines to serve as protection zone.

#### 10.8.6 Rodents - rats and mice

The prime target of rats and mice in the forest nursery is stored or newly sown tree seed, particularly large and medium-sized seed and seed rich in starch or oily substances (e.g. kasoi). But as omnivorous animals rodents also relish tender seedlings.

Rats and mice dig underground tunnel systems, which are often found in dykes and in the elevated separations between floodbeds. In the evening they leave the burrows or other hiding places, and start moving around for food. Apart from the holes and the caused damage, their presence is further revealed through droppings, foot prints and runways.

Although a nursery cat might be a beneficial helper in keeping the nursery free from rodents, the best prevention is a clean nursery with clean surroundings and no idle fallow compartments full with grass. Wire screen covers placed over the seedbeds provide a certain protection. The same is said about seed-dressings using a coating of Lindane, Aldrin or Dieldrin. Snap traps (two sizes available) baited with coconut meat or other palatable tidbits from kitchen wastes will be useful, if the trouble is caused by only a few of the pests.

But in general, the application of slow acting coumarine or warfarin poison baits is the most promising method of rodent control, especially in cases of severe attack. The baits need to be sheltered since they are similarly toxic to humans as well as to domestic animals, but also to protect them from rain. The shelters can be made of

wood, bamboo, cogon or talahib grass, banana sheath, galvanized iron sheet or diagonally cut small kerosene cans. These baiting stations have also a certain luring effect.

#### 10.8.7 Birds

Tree seed sown in open beds is frequently eaten by birds. It is important to cover the sowings carefully, so that birds will not be attracted by exposed kernels and start searching for the still hidden seed. Seedbeds can be temporarily protected by planting narrow strips of tin-foil fastened to a stick all over the bed area. The tin-foil will be moved by the slightest current causing it to blink in the sun and to produce a rattling sound that scares the birds away.

Another way to ward off birds consists of coating the seed (especially pine seed) with a bird repellent like read lead (minium), Morkit or Anthaquinone (see 10.5.1).

Covering the seedbeds with old fishing nets or fine wire netting nailed to a wooden frame is perhaps the safest way of protecting sowings in the open from birds (33,43).

#### ADDRESSES OF IMPORTANT PRODUCER AND SUPPLIER FIRMS FOR AGRICULTURAL CHEMICALS IN THE PHILIPPINES

APPENDIX I

- Hoechst Philippines, Inc.: Corner Pioneer & Reliance Str., Mandaluyong, Rizal
- Marsmann and Co., Inc. : Buendia Ave., Makati, Rizal (Distributor of Sandoz products)
- Ed. A. Keller & Co., Ltd.: 2723 Pasong Tamo Ext., Makati, Rizal (Distributor of CIBA products)
- Warner, Barnes & Co., Ltd.: Makati (Distributor of ICI products)
- Macondray and Co., Inc. : Filipinas Life Building, Makati
- P. E. Zuellig, Inc. : Buendia Ave., Makati
- Shell Chemicals Inc. : 1330 Roxas Boulevard, Manila
- Dow Chemical Pacific, Ltd.: Sikatuna Bldg., Ayala Ave., Makati
- Rohm and Haas  
(AmFil Chemical Corp.) : Sikatuna Bldg., Ayala Ave., Makati
- Union Carbide Phil., Inc.: Ayala Ave., Makati
- Planters Products Makati
- Engro = Esso Standard  
Fertilizer & Agricultural:  
Chemical Co., Inc. (Phil.) 215 Buendia Ave., Makati, Rizal
- Pharmaceutical Industries: Zuellig Bldg. Buendia Ave., Makati  
(Distributor of Geigy products;  
suppliers of Hudson and Birchmeier  
spraying and dusting equipment)

| Active Ingredient                        | Trade Name, Formulation                                                                         | Manufacturer Supplier                                    | Remarks                                                                                                                                                                            |
|------------------------------------------|-------------------------------------------------------------------------------------------------|----------------------------------------------------------|------------------------------------------------------------------------------------------------------------------------------------------------------------------------------------|
| <b>1. Fungicides</b>                     |                                                                                                 |                                                          |                                                                                                                                                                                    |
| copper oxychloride                       | Vitigran Blue 58%, W.P.<br>Shell Copper Fungicide,<br>W.P.                                      | Hoechst<br>Shell                                         | Against diseases on leaves and shoots,<br>particularly those caused by bacteria;                                                                                                   |
| copper + Zineb                           | Cupravit, W.P.                                                                                  | Bayer                                                    |                                                                                                                                                                                    |
| sulfur                                   | Copper Lonacol, W.P.                                                                            | Bayer                                                    | - ditto -<br>powdery mildew, mites;                                                                                                                                                |
|                                          | Elosal 80%, elemental<br>dispersible sulfur                                                     | Hoechst                                                  |                                                                                                                                                                                    |
|                                          | Thiovit 80%, elemental<br>dispersible sulfur                                                    | Marsmann                                                 |                                                                                                                                                                                    |
| Ferbam (iron)                            | Carbamate, W.P.                                                                                 | Niagara                                                  | Ferbam, Zineb and Maneb (dithiocarbama-<br>tes, organic fungicides) are excellent<br>new compounds against diseases on<br>shoots and leaves; Ferbam also used as<br>seed dressing; |
| Zineb (zinc)                             | Shell Zineb 65, W.P.<br>Zinebio, W.P.<br>Zineb 70, W.P.<br>Antracol, W.P.<br>Parcate C, W.P.    | Shell<br>Union Sales<br>Warner Barnes<br>Bayer<br>Dupont |                                                                                                                                                                                    |
| Maneb (manganese)                        | Dithane M-22, W.P.<br>Plantineb 80, W.P.<br>Manebio, W.P.<br>Maneb 80%, W.P.<br>Polyram M, W.P. | Rohm and Haas<br>Hoechst<br>Union Sales<br>Bayer<br>BASF |                                                                                                                                                                                    |
| Maneb + Zineb                            | Dithane M-45, W.P.<br>Manzate 200, W.P.                                                         | Rohm and Haas<br>Dupont                                  | good for seed dressings; as soil drench<br>against damping off; against rust;                                                                                                      |
| Thiram, TMTD                             | Arasan, W.P.                                                                                    | Macondray                                                |                                                                                                                                                                                    |
| <b>Active Ingredient</b>                 |                                                                                                 |                                                          |                                                                                                                                                                                    |
| <b>Trade Name, Formulation</b>           |                                                                                                 |                                                          |                                                                                                                                                                                    |
| <b>Manufacturer Supplier</b>             |                                                                                                 |                                                          |                                                                                                                                                                                    |
| <b>Remarks</b>                           |                                                                                                 |                                                          |                                                                                                                                                                                    |
| <b>Fungicides - continued -</b>          |                                                                                                 |                                                          |                                                                                                                                                                                    |
| organic mercury<br>compounds             | Ceresan L/M, W.P.<br>Tillex, W.P.<br>Agallol, W.P.<br>Semesan, W.P.                             | Macondray<br>Zuellig<br>Bayer<br>Macondray               | seed dressing and soil disinfectant;<br>against damping off; phytotoxic, not<br>to be used as leaf spray; very poison-<br>ous; to be handled with care;                            |
| Chloranil                                | Spergon, W.P.                                                                                   | US-Rubber                                                | seed dressing;                                                                                                                                                                     |
| PCNB (Pentachloro-<br>nitrobenzene)      | Brassicol, W.P.<br>Terrachlor, W.P.                                                             | Hoechst<br>Shell                                         | as soil drench against damping off<br>and root rot; long lasting;                                                                                                                  |
| Dinocap                                  | Karathane 25%, W.P.                                                                             | Esso                                                     | specially against powdery mildew and<br>mites; poisonous;                                                                                                                          |
| Dexon                                    | Dexon, W.P.                                                                                     | Bayer                                                    | seed and soil fungicide; against dam-<br>ping off and root rot; very poisonous;                                                                                                    |
| Captan                                   | Orthocide 50, W.P.                                                                              | Chevron                                                  | excellent fungicides against damping<br>off and foliage diseases; seed pro-<br>tectants; poisonous, particularly to<br>fish;                                                       |
| Difolatan                                | Difolatan-4, W.P.                                                                               | Macondray                                                | seed and soil disinfectant.                                                                                                                                                        |
| Formaldehyde                             | Formalin, concentrated<br>solution                                                              | drugstores                                               |                                                                                                                                                                                    |
| <b>2. Nematocides and Soil Fumigants</b> |                                                                                                 |                                                          |                                                                                                                                                                                    |
| Chloropicrin                             | Picfume, E.C.                                                                                   | Dow                                                      | Teargas; extremely poisonous to hu-<br>mans; to be applied only by trained<br>personnel; as nematocide not as good<br>as D-D; weed seeds, soil insects, soil<br>fungi;             |
| Methylbromide +<br>Chloropicrin          | Dowfume MC 2, gas<br>(Pathofume, Trizone)                                                       | Dow                                                      | extremely poisonous; complicated ap-<br>plication technique; effective against<br>nematodes, soil insects, weed seed,<br>soil fungi;                                               |

| Active Ingredient                 | Trade Name, Formulation                 | Manufacturer Supplier | Remarks                                                                                                                                                                              |
|-----------------------------------|-----------------------------------------|-----------------------|--------------------------------------------------------------------------------------------------------------------------------------------------------------------------------------|
| EDB (Ethylene dibromide)          | Dowfume W 85, E.C.                      | Dow                   | nematodes, soil insects; very poisonous;                                                                                                                                             |
| Dichloropropene + Dichloropropane | D-D, E.C.<br>Telone, E.C.               | Shell<br>Macondray    | badly smelling, very effective nematocide; soil insects; relatively cheap; 3-4 weeks waiting time after treatment; very poisonous; very irritating to the eyes and mucous membranes; |
| SMDC                              | Vapam, E.C.                             | Esso, Macondray       | nematodes, some soil fungi, germinating weed seeds, soil insects; poisonous;                                                                                                         |
| DMTT                              | Mylone, W.P. or granules                | Union Carbide         | nematodes, soil fungi, weed seed, soil insects; convenient application; pois.;                                                                                                       |
| Dazomet                           | Basamid, granules                       | BASF                  | nematodes, soil insects, weed seed, soil fungi; convenient and relatively safe application;                                                                                          |
| DBCP (Dibromochloropropane)       | Nemagon, granules<br>Fumazone, granules | Shell<br>Macondray    | nematodes, damping off; very poisonous.                                                                                                                                              |

All the above-mentioned materials are phytotoxic; they are suitable only for preplanting treatments.

Organophosphorus compounds  
Zinophos, granules  
Nemaphos, granules  
Nemacur P, granules  
Terracur P, granules  
Zuellig  
Zuellig  
Bayer  
Bayer

### 3. Acaricides

|            |                                  |               |                              |
|------------|----------------------------------|---------------|------------------------------|
| Binapacryl | Morocide, W.P.                   | Hoechst       | Also against powdery mildew; |
| Dicofol    | Kelthane, E.C.<br>Kelthane, Dust | Rohm and Haas | specifically against mites;  |

### Active Ingredient Trade Name, Formulation Manufacturer Supplier Remarks

#### Acaricides - continued -

|         |                                                                               |                     |                              |
|---------|-------------------------------------------------------------------------------|---------------------|------------------------------|
| Sulfur  | Elosal, elemental dispersible sulfur<br>Thiovit, elemental dispersible sulfur | Hoechst<br>Marsmann | also against powdery mildew; |
| Dinocap | Karathane 25%, W.P.                                                           | Esso                | same as above; poisonous.    |

### 4. Insecticides

a) Organochlorine compounds: these are insecticides of related composition, but quite different in their action; DDT and Endrin should not be used any more, because of their hazardous side effects; Lindane, Chlordane, Heptachlor, Aldrin, Dieldrin are good against soil inhabiting insects, but must be handled with great care. Among this group only Endosulfan can be recommended as general purpose insecticide.

|                          |                                         |                             |                                                                                                                                                                                                                                                |
|--------------------------|-----------------------------------------|-----------------------------|------------------------------------------------------------------------------------------------------------------------------------------------------------------------------------------------------------------------------------------------|
| DDT                      | DDT 25%, E.C.<br>Resitox 25%, E.C.      | Esso<br>Shell               | Very persistent insecticide; relatively un toxic to mammals, but accumulation in the fat tissues; worldwide danger; very poisonous to fish; because of its persistence not to be used any more;                                                |
| DDD (TDE)                | Rhothane WP 50, W.P.                    | Rohm and Haas               | slightly less effective and toxic than DDT; because of its persistence also not to be used any more;                                                                                                                                           |
| HCH, Lindane (Gamma BHC) | Lindane 20%, E.C.<br>Agrocide' 65, W.P. | Esso<br>Warner Barnes       | fumigant, quick action, short residual effect; soil inhabiting insects, beetles, stem borers, leafhoppers, leaf miners, leafrollers, grasshoppers, mites; rapidly absorbed through the skin; very irritating to the eyes and mucous membranes; |
| Chlordane                | Chlordane 75%, E.C.                     | Esso, Marsmann,<br>Planters | Chlordane, Heptachlor, Aldrin and Dieldrin are nerve poisons with good residual effect; they are especially effective; they are especially effective                                                                                           |

| Active Ingredient                                                                                                                                                                                                                                                                                                                                                                                  | Trade Name, Formulation                                        | Manufacturer Supplier          | Remarks                                                                                                                                                                                                                                                                       |
|----------------------------------------------------------------------------------------------------------------------------------------------------------------------------------------------------------------------------------------------------------------------------------------------------------------------------------------------------------------------------------------------------|----------------------------------------------------------------|--------------------------------|-------------------------------------------------------------------------------------------------------------------------------------------------------------------------------------------------------------------------------------------------------------------------------|
| <u>Insecticides - continued -</u>                                                                                                                                                                                                                                                                                                                                                                  |                                                                |                                |                                                                                                                                                                                                                                                                               |
| Heptachlor                                                                                                                                                                                                                                                                                                                                                                                         | Heptachlor 2E, E.C.<br>Heptachlor 25%, W.P.                    | Planters<br>Esso/Engro         | against ants, termites, roaches, soil insects, leafminers and grasshoppers; with the exception of Chlordane these chemicals are very poisonous;                                                                                                                               |
| Aldrin                                                                                                                                                                                                                                                                                                                                                                                             | Aldrin 40%, D.C., W.P.<br>Aldrex 2, E.C.                       | Shell<br>Shell                 | long residual action; extremely poisonous, also against fish; therefore not recommendable;                                                                                                                                                                                    |
| Diieldrin                                                                                                                                                                                                                                                                                                                                                                                          | Diieldrex 15, E.C.                                             | Shell                          | general purpose insecticide; especially effective against sucking insects; moderately poisonous to mammals, safe to honey bees; very poisonous to fish; recommendable.                                                                                                        |
| Endrin                                                                                                                                                                                                                                                                                                                                                                                             | Endrin 19.5, E.C.<br>Endrin 19.5%, E.C.<br>Endrin 2%, granules | Esso<br>Planters<br>Esso       | general purpose insecticide; especially effective against sucking insects; moderately poisonous to mammals, safe to honey bees; very poisonous to fish; recommendable.                                                                                                        |
| Endosulfan                                                                                                                                                                                                                                                                                                                                                                                         | Thiodan, E.C.<br>Thiodan, W.P., granules<br>Endox 35%, E.C.    | Hoechst<br>Hoechst<br>Planters | Relatively short residual action, but extremely poisonous to humans; the use of goggles, gloves, face mask and protective clothing is mandatory; broad spectrum insecticide against all kinds of sucking and chewing insects; not recommendable because of its high toxicity; |
| b) <u>Organophosphorus compounds</u> : among these chemicals are some preparations that are extremely poisonous to humans. They have however the decided advantage of being detoxified very rapidly in animal tissues. This makes them preferable to the organochlorine compounds. Within this group Diazinon (Basudin), Malathion and Bayrusil are recommendable as general purpose insecticides. |                                                                |                                |                                                                                                                                                                                                                                                                               |
| Parathion                                                                                                                                                                                                                                                                                                                                                                                          | Folidol E605, E.C.                                             | Bayer                          | long lasting residual and penetrative action; extremely poisonous; because of this not recommendable;                                                                                                                                                                         |
| Guthion, Azinphos-methyl                                                                                                                                                                                                                                                                                                                                                                           | Gusathion A40%, E.C.                                           | Bayer                          | long lasting effect; very poisonous; general purpose insecticide; but not recommendable because of its high toxicity;                                                                                                                                                         |
| EPN                                                                                                                                                                                                                                                                                                                                                                                                | EPN 300, E.C.                                                  | Macondray.                     | long lasting residual and penetrative action; extremely poisonous; because of this not recommendable;                                                                                                                                                                         |

| Active Ingredient                 | Trade Name, Formulation                                                                                                                                            | Manufacturer Supplier                                                              | Remarks                                                                                                                                                                                                      |
|-----------------------------------|--------------------------------------------------------------------------------------------------------------------------------------------------------------------|------------------------------------------------------------------------------------|--------------------------------------------------------------------------------------------------------------------------------------------------------------------------------------------------------------|
| <u>Insecticides - continued -</u> |                                                                                                                                                                    |                                                                                    |                                                                                                                                                                                                              |
| Methyl Parathion                  | Folidol M50, E.C.<br>Metacide 480, E.C.<br>Mepaton 50, E.C.<br>Methyl Fosferno, E.C.<br>Meptox 50, E.C.<br>Telothion, E.C.<br>Mephadrex, E.C.<br>Resitox 210, E.C. | Bayer<br>Bayer<br>Pharm. Ind.<br>Warner Barnes<br>Shell<br>Shell<br>Shell<br>Shell | short residual action; very poisonous; broad spectrum insecticide; however, preference should be given to less poisonous preparations;                                                                       |
| + Endrin<br>+ HCH<br>+ Mevinphos  |                                                                                                                                                                    |                                                                                    | effective for more or less 10 days depending on the weather conditions; considerably less poisonous than methyl parathion; general purpose insecticide, recommendable;                                       |
| Diazinon                          | Basudin 20, E.C.                                                                                                                                                   | Pharm. Ind.<br>(Geigy)                                                             | recommendable general purpose insecticide; good residual action; relatively untoxic; one of the safest of all insecticides; but toxic to bees and fish;                                                      |
| Malathion                         | Malathion 57%, E.C.                                                                                                                                                | Esso, Cyanamid<br>Warner Barnes                                                    | for dusting the foliage against chewing insects, where the availability of water to prepare the spray solution is a problem;                                                                                 |
| Dipterex                          | Dipterex 2.5%, Dust                                                                                                                                                | Bayer                                                                              | highly volatile, shortlived, fast acting insecticide; especially in aerosols and baits; for the quick knock-down of free living insects (flies) and of those having infested stored products (seed storage); |
| DDVP (Dichlorvos)                 | Degevap, E.C.<br>Maladrin 2, E.C.                                                                                                                                  | Bayer<br>Shell                                                                     | long residual action; controls a wide range of chewing and sucking insects; recommended;                                                                                                                     |
| Fenthion                          | Lebaycid 50, E.C.                                                                                                                                                  | Bayer                                                                              | short residual action; effective against resistant insect varieties; recommendable new insecticide.                                                                                                          |
|                                   | Bayrusil 25%, E.C.                                                                                                                                                 | Bayer                                                                              |                                                                                                                                                                                                              |

| Active Ingredient                                                                                                                                                                                                                                                                                                                                                                                                                                                                    | Trade Name, Formulation                             | Manufacturer Supplier   | Remarks                                                                                                                                                                                          |
|--------------------------------------------------------------------------------------------------------------------------------------------------------------------------------------------------------------------------------------------------------------------------------------------------------------------------------------------------------------------------------------------------------------------------------------------------------------------------------------|-----------------------------------------------------|-------------------------|--------------------------------------------------------------------------------------------------------------------------------------------------------------------------------------------------|
| <u>Insecticides - continued</u>                                                                                                                                                                                                                                                                                                                                                                                                                                                      |                                                     |                         |                                                                                                                                                                                                  |
| c) <u>Systemic insecticides</u> : are absorbed and translocated to various plant parts when applied to seeds, roots, stems or leaves; therefore not suitable for vegetable production; all plant organs are intoxicated, no weathering of the spray cover, beneficial predatory insects are spared; because of their high toxicity to humans systemic insecticides should be handled with utmost care; useful in the forest nursery, particularly against sucking insects and mites. |                                                     |                         |                                                                                                                                                                                                  |
| Demeton                                                                                                                                                                                                                                                                                                                                                                                                                                                                              | Metasystox, E.C.                                    | Bayer                   | Very poisonous;                                                                                                                                                                                  |
| Di-Syston                                                                                                                                                                                                                                                                                                                                                                                                                                                                            | Disyston 5%, granules                               | Bayer                   | absorbed by the roots; residual action for 6-8 weeks; very effective against leafhoppers, aphids, mites, wireworms; application without water; because of its granule structure relatively safe; |
| Methomyl                                                                                                                                                                                                                                                                                                                                                                                                                                                                             | Lannate-90, W.P.                                    | Dupont, Macondray       | absorbed by the roots; aphids, thrips, leafhoppers, leafminers; very poisonous;                                                                                                                  |
| Monocrotophos                                                                                                                                                                                                                                                                                                                                                                                                                                                                        | Azodrin 168, E.C.                                   | Shell                   | very poisonous;                                                                                                                                                                                  |
| Phosdrin                                                                                                                                                                                                                                                                                                                                                                                                                                                                             | Phosdrin 1.5, E.C.                                  | Shell                   | short residual action; quick knock-down of the pests; extremely poisonous; because of this not to be used in the forest nursery;                                                                 |
| related to Parathion                                                                                                                                                                                                                                                                                                                                                                                                                                                                 | Terracur P 5%, granules                             | Bayer                   | against stemborers, sucking insects and soil insects; very poisonous, but because of its granule structure relatively safe to handle;                                                            |
| d) <u>Carbamates</u> : new useful organic insecticides with broad spectrum action; rapidly detoxified and eliminated from animal tissues.                                                                                                                                                                                                                                                                                                                                            |                                                     |                         |                                                                                                                                                                                                  |
| Zectran                                                                                                                                                                                                                                                                                                                                                                                                                                                                              | Baygon 20%, E.C.<br>Baygon 1%, Dust<br>Baygon, W.P. | Bayer<br>Bayer<br>Bayer | Recommendable general purpose insecticide with longlasting effect;                                                                                                                               |

| Active Ingredient                                                                                                                                                                                                     | Trade Name, Formulation               | Manufacturer Supplier                     | Remarks                                                                                                                                                                     |
|-----------------------------------------------------------------------------------------------------------------------------------------------------------------------------------------------------------------------|---------------------------------------|-------------------------------------------|-----------------------------------------------------------------------------------------------------------------------------------------------------------------------------|
| <u>Insecticides - continued -</u>                                                                                                                                                                                     |                                       |                                           |                                                                                                                                                                             |
| Carbaryl                                                                                                                                                                                                              | Vetox 85, W.P.<br>Sevin 85, W.P.      | Shell<br>Esso                             | recommendable general purpose insecticide with low mammal toxicity;                                                                                                         |
| MIPC                                                                                                                                                                                                                  | Ectofolan 50, W.P.<br>Mipcin 50, W.P. | Bayer<br>Planters                         | same as above.                                                                                                                                                              |
| e) <u>Biological preparations</u> : Very safe in their application; specifically developed for the household and vegetable garden, where safety is given top priority; might be less effective in the forest nursery. |                                       |                                           |                                                                                                                                                                             |
| Bacillus thuringiensis                                                                                                                                                                                                | Thuricide<br>Dipel                    | Shell<br>Abbott Laboratories, Mandatoyong | Slow action; short residual effect; against larvae and caterpillars; application immediately after the first pests have been observed; safe to humans and domestic animals; |
| Pyrethrin + Vapona                                                                                                                                                                                                    | Shelltox<br>Pyredrin                  | Shell<br>Shell                            | rapid knockdown; short residual effect; against chewing and sucking insects; nontoxic.                                                                                      |
| <u>5. Molluscicides</u>                                                                                                                                                                                               |                                       |                                           |                                                                                                                                                                             |
| Metaldehyde                                                                                                                                                                                                           | Metadex 50%, D.C.                     | Warner Barnes                             | For preparing baits against slugs and snails;                                                                                                                               |
| + Calcium arsenate                                                                                                                                                                                                    | Snail killer 8.2%, pellets            | Esso                                      | to be applied at the early stage of attack; also effective against cutworms;                                                                                                |
| Mercaptodimethur                                                                                                                                                                                                      | Merwol 4%, pellets                    | Bayer                                     | same as above.                                                                                                                                                              |

| Active Ingredient                               | Trade Name, Formulation                                        | Manufacturer Supplier                      | Remarks                                                                                                                       |
|-------------------------------------------------|----------------------------------------------------------------|--------------------------------------------|-------------------------------------------------------------------------------------------------------------------------------|
| <b>6. Rodenticides</b>                          |                                                                |                                            |                                                                                                                               |
| Coumarine (anticoagulant)                       | Racumin, Baits<br>Racumin 0.5%, Dust<br>Dora Rat Killer, Baits | Bayer<br>Bayer<br>Fumakilla<br>Lab. Manila | Tasteless and odorless; induce internal hemorrhage, eyesight failing; rats come out to bright places to die; no bait shyness; |
| Warfarin (anticoagulant)                        | Pearl Rat Killer, Baits                                        | Glory Trading<br>Quezon City               | same as above.                                                                                                                |
| <b>7. Bird Repellents</b>                       |                                                                |                                            |                                                                                                                               |
| Anthraquinone                                   | Morkit, W.P.<br>Anthraquinone, W.P.                            | Bayer<br>Keller                            | Used as seed dressing together with suitable fungicides (Ceresan, Agallol).                                                   |
| <b>8. Spray Additives (Spreaders, Stickers)</b> |                                                                |                                            |                                                                                                                               |
|                                                 | Triton B-1956                                                  | Robm and Haas                              | Wetting agent;                                                                                                                |
|                                                 | Shellestol                                                     | Shell                                      | spreader;                                                                                                                     |
|                                                 | Shell Tenac Sticker                                            | Shell                                      | sticker;                                                                                                                      |
|                                                 | Citowett                                                       | Esso                                       | spreader-sticker;                                                                                                             |
|                                                 | Sandovit                                                       | Marsmann                                   | wetting agent;                                                                                                                |
|                                                 | Agral'90                                                       | Warner Barnes                              | wetting agent.                                                                                                                |

SOME USEFUL CONVERSION FACTORS AND EQUIVALENTS  
FOR PESTICIDE APPLICATION

APPENDIX III

|                                                              |                          |                                    |              |                        |
|--------------------------------------------------------------|--------------------------|------------------------------------|--------------|------------------------|
| 1. <u>Weight:</u>                                            | 1 g                      | = 0.035 oz                         | 1 oz (ounce) | = 28.35 g              |
|                                                              | 1 kg                     | = 35.27 oz                         | 1 lb         | = 453.6 g              |
|                                                              |                          | = 2.2 lb                           |              | = 16 oz                |
| 2. <u>Length:</u>                                            | 1 cm                     | = 0.3937 in                        | 1 in         | = 2.54 cm              |
|                                                              | 1 m                      | = 39.37 in                         | 1 ft         | = 12 in                |
|                                                              |                          | = 3.281 ft                         |              | = 30.48 cm             |
|                                                              |                          | = 1.0936 yd                        | 1 yd         | = 3 ft                 |
|                                                              |                          |                                    |              | = 91.44 cm             |
| 3. <u>Area:</u>                                              | 1 cm <sup>2</sup>        | = 0.155 sq.in                      | 1 sq.in      | = 6.45 cm <sup>2</sup> |
|                                                              | 1 m <sup>2</sup>         | = 10.76 sq.ft                      | 1 sq.ft      | = 144 sq.in            |
|                                                              | 1 ha                     | = 2.47 acres                       |              | = 929 cm <sup>2</sup>  |
|                                                              | 1 acre                   | = 0.4047 ha                        |              |                        |
| 4. <u>Volume:</u>                                            | 1 l                      | = 33.8 fl.oz                       | 1 fl.oz      | = 29.57 cc             |
|                                                              |                          | = 1.0567 qt                        | 1 pt (pint)  | = 16 fl.oz             |
|                                                              |                          | = 0.264 gal                        |              | = 473 cc               |
|                                                              | 1 qt (quart)             | = 32 fl.oz                         | 1 gal        | = 4 qt                 |
|                                                              |                          | = 2 pt                             |              | = 8 pt                 |
|                                                              |                          | = 946 cc                           |              | = 3.785 l              |
|                                                              | 1 ganta                  | = 3 l                              |              |                        |
|                                                              | 1 cavan                  | = 25 ganta                         |              |                        |
| 5. <u>Weight and liquid equivalents of common containers</u> |                          |                                    |              |                        |
|                                                              | 1 teaspoon               | = 5 cc                             |              |                        |
|                                                              | 6 teaspoon               | = 1 fl.oz                          |              |                        |
|                                                              | 1 tablespoon             | = 10 cc                            |              |                        |
|                                                              | 1 small milk can         | = approx. 6 fl.oz                  |              |                        |
|                                                              |                          | = approx. 170 cc                   |              |                        |
|                                                              | 1 San Miguel Beer bottle | = 330 cc                           |              |                        |
|                                                              | 1 large kerosene can     | = 5 gal                            |              |                        |
|                                                              |                          | = 19 l                             |              |                        |
|                                                              | 1 ordinary pail          | = approx. 10 l                     |              |                        |
|                                                              | 1 rounded tablespoonful  | = approx. 4.5 g (wetttable powder) |              |                        |



## 6. Equivalents for diluting emulsifiable concentrates in water

|                                |                         |
|--------------------------------|-------------------------|
| 4 tablespoons per kerosene can | = 1 qt per 100 gal      |
| 2 tablespoons per kerosene can | = 1 pt per 100 gal      |
|                                | = 125 cc per 100 l      |
|                                | = 1 tablespoon per 10 l |
| 1 tablespoon per kerosene can  | = ½ teaspoon per gallon |
|                                | = 0.6 cc per liter      |
| 1 tablespoon per gallon        | = 2.5 cc per liter      |
| 1 teaspoon per gallon          | = 1.25 cc per liter     |

## 7. Equivalents for diluting wettable powder in water

|                                          |                           |
|------------------------------------------|---------------------------|
| 5 tablespoons (rounded) per kerosene can | = 1 lb per 100 gal        |
|                                          | = 1 tablespoon per gallon |
|                                          | = 12 g per 10 l           |

## 8. Equivalents for soil treatment (sprays, dusts, granules)

|               |                       |
|---------------|-----------------------|
| 1 pt per acre | = 1.17 l per hectare  |
| 1 l per ha    | = 0.85 pt per acre    |
| 1 lb per acre | = 1.12 kg per hectare |
| 1 kg per ha   | = 0.89 lb per acre    |
|               | = 0.1 g per sq.m      |

## 9. Pressure

|                   |                             |
|-------------------|-----------------------------|
| 1 at (atmosphere) | = 1 kg per cm <sup>2</sup>  |
|                   | = 14.223 psi (pounds/sq.in) |
| 1 psi             | = 0.07 at                   |

## 10. Temperature

Conversion °Celsius into °Fahrenheit

$$\frac{9}{5} x ^\circ C + 32 \quad \text{or} \quad (1.8 x ^\circ C) + 32$$

Conversion °Fahrenheit into °Celsius

$$\frac{(^{\circ}F - 32)}{9} x 5 \quad \text{or} \quad (^{\circ}F - 32) x 0.556$$

## REFERENCES

1. AGRIOS, G.N., 1969, Plant pathology. Academic Press, New York.
2. ANDRES, P.R., 1969, Field planting methods and techniques. Reforestation Monthly Vol. XIII, Nos. 9 & 10.
3. ASIDDAO, F., et JACALNE, D.V., 1958, Response of mahogany seedlings to underground root pruning. The Filipino Forester, Vol. IX & X.
4. BARNARD, R.C., 1956, A manual of malayan silviculture for low-land forests; part IV, artificial regeneration. Malayan Forest Service, Kuala Lumpur.
5. BENNETT, H.H., 1955, Elements of soil conservation. Second edition, McGraw-Hill Book Company, Inc. New York.
6. BINUA, T.M., 1969, Stump and seedling planting of teak in Cebu and Bohol. Reforestation Monthly, Vol. VIII, Nos. 7 & 8.
7. VON BLANCKENBURG, P., et CREMER, H.D., 1971, Handbuch der Landwirtschaft und Ernährung in den Entwicklungsländern. Verlag Eugen Ulmer, Stuttgart.
8. BRUMM, F., et MEHLISCH, K., 1964, Der Baumschulbetrieb. Verlag Eugen Ulmer, Stuttgart.
9. DELIZO, T.C., 1964, Forest nursery and plantation handbook for the Philippines. U.P. College of Forestry, Los Baños.
10. DOMINGO, J.L., 1964, Quality, survival and growth of planting stock as affected by underground root-pruning. Technical Bulletin No. 1, U.P. College of Forestry, Los Baños.
11. GALO, J.G., 1959, Control of damping off of Benguet pine (*Pinus insularis* Endl.) in seedbeds with Dowfume MC-2 and Formaldehyde. Phil. Jour. of For., Vol. 13, Nos. 3-4.
12. GLASS, E.H., et al., 1968, A manual of pesticides. U.P. College of Agriculture, Los Baños.
13. GOOR, A.Y., 1963, Tree planting practices for arid zones, FAO, Rome.
14. GÜNTHER, G., und WACHENDORF, R., 1966, Chemische Unkrautbekämpfung in der Forstwirtschaft. BLV, München.
15. HARTMANN, H.T., KESTER, D.E., 1968, Plant propagation. Prentice Hall Inc., Englewood Cliffs, New Jersey.

16. HEDDERGOTT, H., 1971, Crop protection guide. Landwirtschaftsverlag GmbH, Hiltrup.
17. JACALNE, D.V., 1959, Reproduction of paper mulberry (*Broussonetia papyrifera* Vent.) by root sprouts. Phil. Jour. of For. Vol. 15, Nos. 1-4.
18. JUNG, J., et RIEHLE, G., 1969, Beurteilung und Behebung von Ernährungsstörungen bei Forstpflanzen. BLV, München.
19. KNOTT, et DEANON, 1967, Vegetable production in Southeast Asia. U.P. College of Agriculture, Los Baños.
20. KONEMANN, E., 1968, Neuzeitliche Kompostbereitung. Waerland-Verlagsgenossenschaft EGmbH, Mannheim.
21. KOHNKE, H., 1966, Soil science simplified. Balt Publishers, Lafayette, Indiana.
22. KRÜSSMANN, G., 1964, Die Baumschule. Verlag Paul Parey, Hamburg.
23. LAMPRECHT, W., 1967, Forstschutztechnik. BLV, München.
24. LETORNEUX, C., 1957, Tree planting practices in Tropical Asia. FAO, Rome.
25. LOYCKE, H.J., MATTHIES, F., DOSTAL, D., 1968, Rationalisierung des Pflanzgartenbetriebes durch Mechanisierung. Landwirtschafts-Verlag GmbH, Hiltrup.
26. LOYCKE, H.J., 1963, Die Technik der Forstkultur. BLV, München.
27. LYON, T.L., BUCKMAN, H.O., BRADY, N.C., 1952, The nature and properties of soils. Fifth edition, The Macmillan Company, New York.
28. MCGRAW-HILL Yearbook of Science and Technology 1969. Mycorrhizae.
29. METCALF, R.L., 1962, Destructive and useful insects. Agricultural Experiment Station, University of California, Riverside.
30. MORTENSEN, E., et BULLARD, E.T., 1966, Handbook of tropical and sub-tropical horticulture. Department of State, Agency for International Development, Washington, D.C..
31. NELSON, K.S., 1967, Flower and plant production in the greenhouse. Ohio State University, Columbia, Ohio.
32. POSTRADO, B.T., et GLORI, A.V., 1968, Root-knot nematode: potential threat to kaatoan bangkal. Research Note No. 2, Sept. 1968, Reforestation Administration, Quezon City.
33. RUPF, SCHÖNHAR, ZEYHER, 1961, Der Forstpflanzgarten. BLV, München.
34. SAMAKA SERVICE CENTER, 1962, The samaka guide to homesite farming. Manila.
35. SMITH, R.S., et BEGA, R.V., 1966, Root disease control by fumigation in forest nurseries. Plant Disease Reporter, Vol. 50 No. 4., U.S. Forest Service.
36. SURI, P.N., et SETH, S.K., 1959, Tree planting practices in temperate Asia. FAO, Rome.
37. TOUMEY, J.W., et KORSTIAN, C.P., 1942, Seeding and planting in the practice of forestry. Third edition, New York.
38. U.P. COLLEGE OF AGRICULTURE, 1970, Rice production manual. Los Baños.
39. U.P. COLLEGE OF AGRICULTURAL ENGINEERING, 1967, Irrigation and drainage principles and practices. Los Baños.
40. U.P. COLLEGE OF FORESTRY, 1970, How to raise kaatoan bangkal. Forestry Popular Bulletin No. 4, Los Baños.
41. VALIENTE, G.C., 1970, Potting machine for polyethylene plastic bags. Reforestation Monthly Vol. IX. Nos. 6, 7 & 8.
42. VOLGER, CHR., 1962, Verfahren der Bodenentseuchung und ihre Bedeutung für die Anzucht von Forstpflanzen. J.D. Sauerländer's Verlag, Frankfurt.
43. WORMALD, T.J., 1969, A nursery handbook for the Philippines. Manila

PART V

EROSION CONTROL

K. UNKEL and D. ENDANGAN

Chapter 1:

KINDS OF EROSION

1.1 Erosion by natural forces and human interference

- a) Geological erosion takes place without human interference. Steep and high mountains formed by geological processes millions of years ago have been smoothed and worn down by natural forces throughout the ages. By chemical and physical action the rocks withered, the debris and fine materials were carried down by gravity or flowing water to form plains with fertile soils or to fill up vast deposits in the ocean. The process of geological erosion is slow and changes are hardly visible within the life time of human beings. Geological erosion is still in progress practically everywhere, but most pronounced in recent geological formations. Old landscapes -old in a geological sense- have already acquired some kind of stability and show smooth topographical features. In younger formations, which the Philippines are mainly composed of, a dynamic process of change is still going on and the landscape responds even to a slight disturbance by man with violent erosion.
- b) Accelerated erosion is mainly the result of man's activity. When we use the common term "erosion" we generally refer to this man-made erosion. It is responsible for landslides and floods, loss of fertile soil and soil nutrients, silting up of reservoirs, damaging roads and other communication lines. Due to erosion, vast areas, which had been known as granaries before, turned into steppes or even deserts.

According to the active force, we can distinguish: Wind erosion, gravity erosion and water erosion.

## 1.2 Wind erosion

In wide plains of low rainfall wind erosion is quite common. There, steadily blowing winds loosen the soil particles and transport them to other places. The higher the wind velocity, the larger the particles that can be dislodged.

Wind erosion is a problem in the prairies of the Middle West of the USA, in North Africa and the Middle East, but hardly in Southeast Asia.

## 1.3 Gravity erosion

Gravity erosion is the movement of soil due to its own weight. When the movement is slow, we speak of a "soil creep", when it is sudden, we call it a "landslide".

a) Soil creep occurs on steep slopes. The movement is so slow, that it is hardly perceptible. The entire mass of soil moves downhill as a unit without any evidence of clefts or cracks on the surface. A high content of water in the soil favors creeping by increasing the weight and acting as a lubricant. The lubricating effect of water is particularly evident where there is an impermeable layer beneath.

b) Landslides can be common in regions of steep and precipitous slopes. In a landslide great masses of soil and rocks suddenly rush down leaving behind large wounds in the landscape, which may widen by subsequent landslides and get cut up by gullies. The debris is piled up at the base of the slope and may cause obstruction of water ways, destroy roads, bridges, houses or farm lands. The occurrence of landslides can have the following reasons:

- Increased weight of soil after prolonged and heavy rainfall,
- Faulty drainage, which also can cause gullies,
- Undercutting along stream banks,
- Road cuts, which often remove the support for large soil masses,
- Cutting of trees, whose tap roots might have served as an anchorage to keep the soil in place,

- Earthquakes,
- Internal movements in the geological formation.

The danger of landslides is increased where the geological strata show unfavorable directions (Fig. 1).

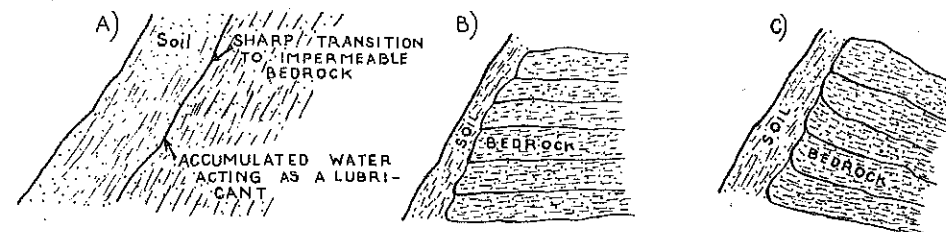

Fig. 1: (a) Unfavorable directions of geological strata increased by a sharp transition to the bedrock, (b) and (c) favorable directions of geological strata.

## 1.4 Water erosion

Water is the most active force that can cause erosion. We can distinguish the following forms: Raindrop or splash erosion, sheet erosion, rill erosion, gully erosion, river bank erosion, and bank erosion in stagnant waters.

a) Raindrop or splash erosion: In contrast to erosion caused by flowing water, raindrop erosion has a more smoothening or levelling effect, which can be demonstrated by drops falling into a sandpile. If a raindrop hits a level surface vertically, the finer soil particles will uniformly splash in all directions. But where the raindrops hit a slope, most of the soil particles will be dislodged downward. Thus, over longer periods large quantities of soil will be transported downhill (BENNET, 1955).

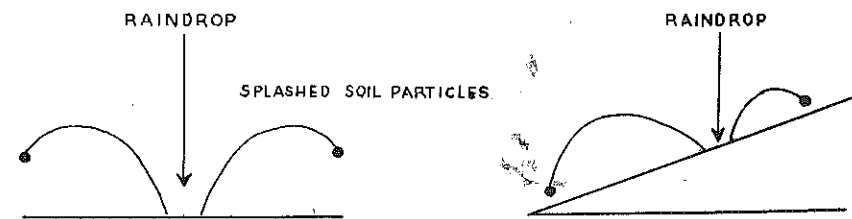

Fig. 2: Dislodging of soil particles by splash erosion on a level and sloping surface (After BENNET, 1955).

Furthermore, the kinetic energy of falling raindrops destroys the crumb structure of the surface soil by breaking up the soil aggregates. The loosened particles form a puddled layer of surface mud, which will clog the pores. This reduces infiltration, and thereby increases run-off and erosion.

- b) Sheet erosion: is the removal of soil in thin layers from the surface due to surface flow. The process is generally slow and hardly visible, but when it becomes apparent, it will be often too late and much of the fertile soil will have been lost already. Usually, sheet erosion is increased by splash erosion, after the impact of the raindrops has loosened the soil particles from their moorings.

The disappearance of one cubic meter of soil every week on a hectare of land will hardly be noticed, but if that continues for 60 years, this would mean the loss of not less than one foot of topsoil. No wonder that the fertility of the land will fade because of the continuous losses of topsoil and soil nutrients.

Splash erosion alone just moves quantities of soil downhill to the base of the slope, it does not transport the soil further. Surface flow, however, on reaching the foot of the slope carries the soil away as suspension. Generally, splash and sheet erosion join forces and are responsible for removing large quantities of fertile topsoil (BENNET, 1955).

- c) Rill erosion: Due to irregularities of the soil surface the water is often forced to concentrate in small and shallow canals, which is where rill erosion starts. The flowing water loosens the soil particles, lifts them up and transports them away. The more water is concentrated in these rills, the higher will be the erosive power. Rill erosion can be smoothed by tilling or ploughing, provided the rills are not deeper than one foot.

- d) Gully erosion is similar to rill erosion and can be considered its advanced stage. Gullies are formed when many rills join, which will increase the volume and the erosive power of the water flow. Unlike rills they cannot be levelled by

ploughing anymore because of their depth. Gully erosion is very destructive. Vast amounts of soil are carried away and only steep canals and ridges are left behind.

The development of a gully shows several distinct stages, which should be known, so that the right control measures can be adopted.

- First stage : Sheet erosion develops into rills,
- Second stage : The rills gain depth and reach the B-horizon,
- Third stage : The gully reaches the parent rock or C-horizon. If the underlying material is not very resistant, gullies of great depth may be formed,
- Fourth stage : Having reached the necessary depth, the gully is "eating backwards", which is caused by waterfall erosion at the gully head. Falling water carves a hollow by splash into the bottom of the steep head wall. When the excavation is deep enough, the upper portion will collapse. This process will recur again and again, so that the gully increase in length (Fig. 3).
- Fifth stage : The gully broadens by cutting along the outside curves, and also increases in depth. It may eventually turn into a ravine.

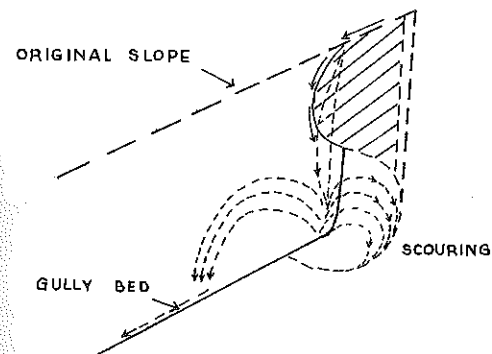
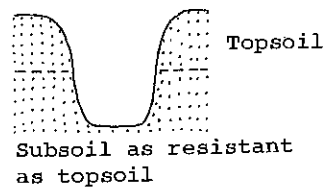

Fig. 3: Waterfall erosion at a gully head

Gullies can have different shapes. U-shaped gullies are formed, where the subsoil erodes as easily as the topsoil. These gullies develop almost vertical walls (Fig 4a). V-shaped gullies are formed in soils with a more resistant subsoil.

This is the most common form of gully in the Philippines and elsewhere (Fig. 4b). A combination of both can be observed in soils with a very resistant layer below the surface. In that case, the gully has a rather trapezoidal shape, because the water erodes more along the banks (Fig. 4c).

(a) U-shaped gully



(b) V-shaped gully

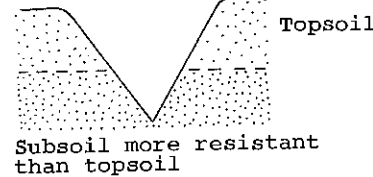

(c) Trapezoidal gully

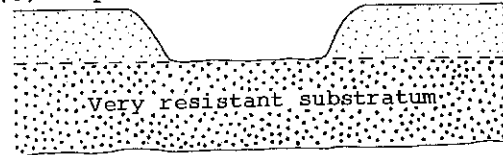
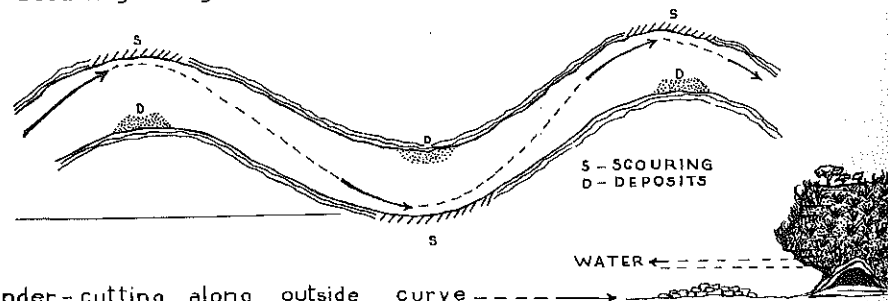

Fig. 4: Shapes of gullies

A classification of gullies according to their size is given by BENNET (1955):

- rills : less than 1 foot deep,
- small gullies : less than 3 feet deep,
- medium gullies : 3 to 15 feet deep,
- large gullies : 15 to 30 feet deep,
- ravines : more than 30 feet deep.

e) River bank erosion: River banks are eroded by flowing water scouring along the banks. The extent of erosion on a river



Under-cutting along outside curve

Fig. 5: Scouring and deposition along a meandering stream

bank depends on the velocity and the direction of the flow. Generally we can observe erosion on the outside of a bend and deposit of materials on the inside bends (Fig. 5).

The material transported by flowing water is called sediment. It can be carried in three ways, as:

- Suspension: Sediment that remains suspended in water without contact with the stream bed is called suspension. It is carried far, because just a slight turbulence will keep it suspended.
- Saltation: When soil particles and small stones bouncing along the stream bed and touch the ground in short intervals, we speak of saltation.
- Bed load: Sediment that moves in almost constant contact with the stream bed is called bed load. The material is of larger size and cannot be lifted by the current. It is just rolled or pushed along the stream bed.

When and wherever the velocity and the carrying capacity of the stream flow decreases, the sediments will fall out. At first the bed load is deposited, then the materials carried by saltation, and finally the suspended particles. On cut river banks, zones of finer and coarser materials can therefore often be distinguished, which sometimes correspond to the annual fluctuations of the river due to wet and dry seasons.

f) Bank erosion in stagnant waters: can be observed along banks or shores of lakes or canals and along the sea. Serious bank erosion is caused by rolling waves undercutting the banks. The damage is increased during strong winds and typhoons. Along narrow water ways strong waves can also be generated by motor vessels.

FACTORS AFFECTING EROSION

Without the interference of man and his livestock there would be hardly any noticeable erosion, except geological erosion, which is a natural process. A dense vegetative cover protects the soil surface from the impact of the rain drops and keeps it in place. However, accelerated erosion will occur as soon as the protecting vegetation is destroyed. The progress of erosion depends mainly on the following factors: rainfall, topography, soil properties and vegetative cover.

2.1 Rainfall characteristics

- a) Total annual rainfall: Because of the direct relationship between the annual rainfall and the amount of run-off, the height of the annual rainfall may give some indication about erosion problems. But the total annual rainfall does not permit any conclusions about the length of the wet and dry season, though their duration is most important for plant growth.
- b) Monthly distribution of rainfall has a bearing on erosion in two ways: it affects the development of the vegetation, and gives some indications about the rainfall intensity. To illustrate this let us consider two extremes:
  - Place A: rainfall more or less evenly distributed, no month receives less than 150 millimeters (Eastern Mindanao).
  - Place B: rainfall is concentrated on five months, which may receive as much as 1000 millimeters monthly mainly brought by typhoons (Baguio).

While in place A the uniform distribution of rainfall permits a luxuriant vegetation throughout the year, which protects the soil from erosion, the ground vegetation in place B dries up due to the prolonged dry season, and may be subject to fire in many places. Here, the rains will hit a poorly protected surface at the beginning of the wet season. And, because of the seasonal rainfall the vegetation is not as highly developed as in a humid climate. It is therefore easy to understand, that in a pronounced seasonal climate with concentrated high rainfall, erosion problems are more severe than under constantly humid conditions.

- c) Rainfall intensity is one of the important factors that directly affect erosion. It is expressed in millimeters or inches per hour. Rain causes little erosion as long as the rainfall intensity does not exceed the infiltration capacity of the soil. But there will be increased run-off and increased erosion, if more rain falls than can immediately infiltrate into the soil. Rains of high intensity also damage the structure of the surface soil by releasing silt and clay particles that clog the pores. The hammerlike action of the raindrops breaks down the crumb structure with its intricate pore system, and so reduces the infiltration capacity.

Fortunately, storms of high intensity usually last only for short periods and generally cover relatively small areas. But if they last long and cover large areas, the erosion damage may be considerable and devastating floods may occur like the flood in North and Central Luzon in 1972. In most parts of the Philippines rainfall of high intensity has to be expected during the typhoon season between July and October.

2.2 Topographic characteristics of the watershed

The watershed or catchment is the total area that drains into a certain water way. Since it is the catchment or part of it that receives the rainfall, the damage caused by erosion will depend on the size and configuration of the watershed area. The characteristics of the catchment must, therefore, be studied in detail before any large-scale erosion control or watershed protection work is commenced.



- a) Size of the catchment: The larger the catchment the higher is the run-off. In the field and on a map it is usually not difficult to define the boundaries of a watershed by studying the topography or contour lines of the area.

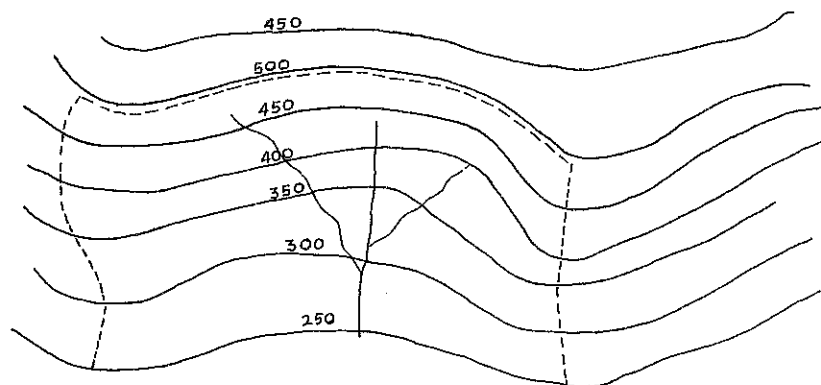

Fig. 6: Delineation of a catchment according to contour lines

- b) Length of the slope: On long slopes there is usually an accumulation of water towards the base. Conducting this water safely downhill over long distances is one of the main problems. Rarely are there stable natural waterways well distributed over the slope to collect the run-off. If there are any, they must be strictly protected and not be made part of a kaingin. For that reason Philippine Forest Law protects the vegetation 50 meters above the highest water level on both sides of natural water courses that are more than 5 m wide. For the safe conduct of the run-off waterways in farmland have been successfully lined with grass. It retards the flow and protects the bottom and the banks from scouring.
- c) Gradient of the slope: The steeper the slope the higher are the velocity and the erosive power of the run-off. As the surface flow concentrates into streams and channels, it develops turbulences, which in turn considerably increase the carrying and scouring capacity of the current.

Under normal conditions the approximate transporting capacity would be as follows:

|          |                                  |
|----------|----------------------------------|
| 0.3 km/h | fine clay                        |
| 0.5 km/h | fine sand                        |
| 0.7 km/h | coarse sand                      |
| 1.0 km/h | fine gravel                      |
| 2.0 km/h | pebbles up to about 2.5 cm       |
| 3.0 km/h | smaller stones up to about 5 cm. |

Flow loaded with sediments that are carried by saltation or as bed load, has a strong abrasive action like sandpaper.

### 2.3 Physical soil properties

- a) Soil texture refers to the proportion of fine and coarse particles in the soil. The following texture classes or soil classes are generally recognized: Sand, loamy sand, sandy loam, loam, silt loam, clay loam, clay. They can be easily determined by field characteristics. For details consult Part 2, Chapter 2 of this book.

From clay to sand we can observe an increase in infiltration capacity, but a decrease in resistance against erosion. Loam, which is listed in the center of the following scale has a favorable combination of both.

| Soil class | Infiltration capacity<br>inches / hour |
|------------|----------------------------------------|
| Loamy sand | 1 - 2                                  |
| Loam       | 0.5 - 1                                |
| Silt loam  | 0.3 - 0.6                              |
| Clay loam  | 0.1 - 0.2                              |

Table 1: Infiltration capacity of different soil classes (KOHNKE and BERTRAND, 1959)

Other important aspects, which influence the growth of vegetation are the water holding capacity of the texture classes and the actual availability of water to plants. The total quantity of water a soil can absorb is called "field capacity", which differs considerably according to soil type (see below).

Out of this a certain portion of water will not be available to the plants, because their roots cannot overcome the high osmotic, capillary and adhesive forces, by which the moisture is held in the soil. This lower limit of the soil water content for plant life is the "wilting point", which differs with the soil classes. Only the difference between the field capacity and the water content at the wilting point constitutes the amount of available water.

| <u>Soil class</u> | <u>Field capacity</u> | <u>Wilting point</u> | <u>Available water</u> |
|-------------------|-----------------------|----------------------|------------------------|
| Fine sand         | 1.5 inches/foot       | 0.5 inches/foot      | 1.0 inch/foot          |
| Loam              | 3.2                   | 1.2                  | 2.0                    |
| Clay              | 3.9                   | 2.5                  | 1.4                    |

Table 2: Field capacity, wilting point and available water for the main soil classes

Of the three main soil classes, it is in loam where the availability of water is highest. Especially in critical rainfall areas, loam and closely related texture classes therefore offer the most favorable conditions for the development of vegetation.

On the other hand, soils with a high field capacity like clay soils become very heavy when their saturation point is reached and so may become liable to landslides or soil creep. The danger is aggravated where the soil has been dumped, which results in pores with an increased volume.

b) Soil structure refers to the arrangement of individual soil colloids into aggregates of certain shape and size. The following terms are commonly used to describe the various structure types:

- plate-like: The natural cracking is markedly horizontal; common in clay soils, which are rich in kaolinite,
- prismatic: The cracking is pronounced in vertical direction. This structure develops in the B-horizon of heavy clay soils, especially in a dry climate,
- blocky: Horizontal and vertical cracking are equally well developed. The shape of units is irregular, which results

in structural aggregates with sharp edges and smooth faces. The sizes of the units range from 1 to 50 mm. This is the most common structure type found in Philippine soils,

- granular or crumb structure: The particles are more rounded with a size of 1 to 10 mm. Of all structure types, the granular structure can harbor the largest volume of air and water. The permeability of soils with such a structure is very high. They are therefore less liable to erosion as long as the rainfall is not excessive. The crumb structure is most pronounced in A-horizons with a high humus content,
- amorphic: Without visible structure; in pure clay soils.

## 2.4 Chemical soil properties

Apart from their influence on plant growth, chemical soil properties have a direct bearing on the stability of the soil structure and the resistance the soil offers against erosive forces.

For example, the content of organic matter influences the formation of stable humus aggregates visible as crumb structure with a favorable infiltration capacity. Iron oxides are at least partly responsible for the favorable physical properties of lateritic soils, in which they are dominant, by binding soil colloids into stable aggregates with a large pore volume.

While calcium and magnesium ions also have a favorable influence on the soil structure, a concentration of sodium ions may cause the breakdown of any soil aggregates because of the high dispersing power of this element. Soils, with a high sodium content may be highly plastic and are very unstable when in contact with water. These soils pose great difficulties for stabilization, particularly when dumped.

## 2.5 The influence of the vegetative cover

A dense vegetative cover provides the best protection against erosion. The denser and more complex it is, the more complete the protection.

- A vegetative cover particularly a canopy of trees and shrubs, not only prevents the raindrops from striking the ground directly, but is also able to break their kinetic energy.
- Vegetation is constantly adding organic matter to the soil and increases its water absorbing capacity by improving the soil structure.
- Decaying roots of trees and shrubs leave numerous galleries in the soil, which increase infiltration.
- Roots bind the soil and prevent it from being washed away.

The effectiveness of the vegetation, however, varies according to its density and composition. Whether a grass cover or a forest is more effective to prevent erosion, depends largely on the conditions of the land and the way both types of land-use are managed (see table 3).

| Sandy clay loam, Southern Piedmont |       |              | Fine sandy loam, Northeast Texas |        |              |
|------------------------------------|-------|--------------|----------------------------------|--------|--------------|
| Land-use                           | Slope | Tons/Ha/Year | Land-use                         | Slope  | Tons/Ha/Year |
| Virgin forest                      | 10 %  | 0.005        | Forest                           | 12.5 % | 0.124        |
| Grass                              | 10 %  | 0.76         | Grass                            | 16.5 % | 0.012        |
| Agricultural rotation              | 10 %  | 37.26        | Agricultural rotation            | 8.75 % | 42.5         |
| Cotton                             | 10    | 77.11        | Cotton                           | 8.75 % | 57.38        |
| Bare ground                        | 10 %  | 163.41       | Cotton on subsoil                |        | 162.0        |

Table 3: Annual soil losses by erosion under different soil covers for two localities in the U.S. (After BENNET, 1955)

As shown in table 3 the annual soil loss under a forest is in both cases below 0.2 tons per hectare, under grass below 1 ton per hectare. Soils under agricultural crops in contrast are much more liable to erosion, which can amount to 77 tons in a cotton field, or even to 162 tons where cotton is planted on subsoil.

Good and well managed pasture land not subjected to annual fires is much less liable to erosion than a poor and open pine forest. On the other side, an intact virgin forest with several strata of vegetation usually has a much higher protection value than even the best grassland.

Pure pine forests do not appear to offer the best possible protection from erosion for various reasons. Pine stands generally have a light canopy, intercept little rainfall, and their litter does not improve the soil. Furthermore, their ground vegetation consists mainly of grasses, which are susceptible to fire. Pine forests can only form an effective ground cover when they have an understorey of broad-leaved species.

### Chapter 3:

#### HUMAN INTERFERENCE AS THE MAIN CAUSE OF EROSION

##### 3.1 Logging and fuelwood cutting

Excessive logging and fuelwood cutting has to be made responsible for the forest destruction over large areas in the Philippines.

Logging for mining timber has been blamed for the denudation of wide areas in the Binga-Ambuklao Watershed. The situation is aggravated by improper logging practices, which destroy the ground vegetation by skidding.

In the dry Ilocos region, the high demand for fuelwood for curing tobacco accelerated forest destruction with the consequence that mountains and hills became susceptible to erosion, and land and water resources deteriorated.

### 3.2 Kaingin making

In the Philippines, according to FAO estimates (Technical Report on Shifting Cultivation), about 80,000 hectares are destroyed annually by kaingin. The kainginero usually enters the forest areas after they have been opened up by the logger.

Kaingin is especially harmful in densely populated areas, where the farmers can only allow a very short resting period between successive fellings. After each cycle the secondary vegetation becomes more degraded and offers less protection against erosion. Finally only grasses will grow. In that stage the kainginero cannot make a living from the land any more, so that it may be utilized as a meager pasture subject to annual fires.

If the pressure on the land is very high, even the steepest slopes of 100% or more would be cultivated. Where the fields are large and the crops cultivated not very protective, heavy erosion will be unavoidable. Also the strips adjacent to rivers are not spared, because they offer the most fertile land.

### 3.3 Forest fires and grassland burning

Forest fires are a problem in seasonal climates and are especially destructive in forests with a ground cover of dry grasses. After most of the ground vegetation and smaller trees have become the victim of grass fires, erosion damages are greatly increased.

Vast areas are deliberately burnt over by cattle ranchers every year at the peak of the dry season, when all grasses are dried up and are most inflammable. The objective is to get rid of the old cogon (*Imperata cylindrica*), which is not palatable to the cattle, and to induce fresh growth suitable for forage. Thus, at the beginning of the raining season the rains will hit a poorly protected surface.

However, annual fires favor *Imperata* more than any other grass species, all the better fodder grasses will eventually disappear. Since in every grass fire vast amounts of nitrogen are lost, the site degrades constantly. The A-horizon, usually already quite thin, is reduced even more and may completely disappear, which increases the danger of erosion.

### 3.4 Improper range management

Three basic mistakes in range management can be commonly observed: premature grazing, overgrazing, and continuous grazing.

- a) Premature grazing: Very often the cattle is allowed to graze when grasses and palatable herbs are just sprouting. If the young shoots are grazed off right after their formation, they cannot contribute anything for the build-up of the plant. For the formation of the first shoots the plants depend largely on their root reserves. Only after having grown for some time the plant is in a position to contribute carbohydrates for its own increase. If the grazing is not restricted during the first weeks of the rainy season, the root system of the fodder grasses will become weaker and weaker and may eventually die.
- b) Overgrazing: In overgrazed pastures the vegetative cover will soon be destroyed. Furthermore, browsing paths occur, on which the soil will be compacted by the trampling of livestock. These paths are typical for overgrazed pastures and often become the beginning of rill and gully erosion, or even of landslides on steep slopes.
- c) Continuous grazing affects the pasture in several ways. When the animals graze the pasture more than once a month, the removal of the new leaves tends to weaken the root stock of the plant, so that there may not be sufficient roots to hold the soil particles together against the erosive power of the runoff. As the grasses are not allowed to mature and to seed, they gradually disappear leaving behind but a few unpalatable species.

### 3.5 Road cuts

In steep slopes road cuts are very often the beginning of erosion. High cuts above and dumps of the excavated material below the road are very vulnerable. The danger is often increased by improper drainage.

### 3.6 Improper disposal of mining waste

is quite a problem in Northern Luzon. These dumps with their steep slopes are liable to heavy erosion during the rainy season, and large quantities of sterile material are washed into the rivers rendering the water unsuitable for any use.

### 3.7 Improper drainage

A large number of erosion cases like gully formation and landslides can be traced back to improper drainage and careless discharge of accumulated rainwater from roads or buildings with a large roof surface. With the high rainfall intensities the disposal of the run-off is one of the important aspects to be taken care of in planning any construction. Since most construction work is carried out during the dry season, provisions for the safe drainage of large quantities of run-off are often forgotten.

## Chapter 4:

### THE EFFECTS OF EROSION

#### 4.1 Deterioration of farm land

When the fertile top soil containing the badly needed humus is washed away from the fields, the less fertile subsoil is exposed, which generally does not respond well to fertilizer and gives only meager harvests.

With the top soil, also large quantities of plant nutrients are lost. If an attempt would be made to replace these losses with commercial fertilizer, the costs would probably run into millions of pesos every year.

After the land has been cut up by gullies, mechanized cultivation becomes very difficult. At this stage the farmer may decide eventually to abandon the land.

Not only the scouring of top soil threatens the fields, but they may also be buried under debris and sediments coming from denuded hills. Under geological erosion, soil is gradually washed down to form fertile alluvial deposits. But when this erosion turns into accelerated erosion, together with the top soil large quantities of gravel, sand and boulders and infertile subsoil are carried along. Deposits of this kind on agricultural fields may render them unsuitable for cultivation, and also destroy irrigation facilities.

#### 4.2 Increase of floods

Whenever rain falls on a forested watershed, part of the rain is intercepted by the various strata of the vegetation before it reaches the ground. The raindrops trickle down through the leaves of the top and middle storey, through the ground flora and along the stems of trees and shrubs. On reaching the ground they are absorbed by the layer of decomposed and semi-decomposed litter, which acts like a sponge and is capable of taking up large quantities of water. In the absence of vegetation, however the raindrops strike the soil with full force. There will be nothing to hold back excessive run-off, which will accumulate

in the rivers and cause floods.

#### 4.3 Reduced water supplies

Under forest conditions we have an optimum of water infiltration into the soil. The water is stored and will be gradually released throughout the year. This regulating effect is very important in regions with pronounced wet and dry seasons. Under the ideal conditions of a forest watershed springs will yield water throughout the dry season. Rivers originating from eroded watersheds, in contrast, often dry up during this time, while during the rainy season they may just yield a muddy run-off.

We have to admit that a forest cover also consumes large quantities of water by transpiration and evaporation. For that reason the total run-off from a watershed without vegetation may be even higher than from a forest. The main advantage of the vegetation, however, is the regulating and purifying effect on the run-off.

#### 4.4 Silting-up of reservoirs, canals and rivers

Another serious effect of erosion is the sedimentation of water reservoirs. By sedimentation with silt and debris the storage capacity of the dams is greatly reduced. Soon the point may be reached where they do not serve their purpose any longer, and the enormous expenses for their construction and for the installation of the power plants do not give the expected returns. Excessive silting has reduced the expected lifespan of the Ambuklao dam, for example, from 62 years to 32 years.

The gradual silting-up of any reservoir is a natural phenomenon due to unavoidable geological erosion, but the rate is very slow and is estimated at only a few meters in a hundred years.

Sedimentation can also become a problem in irrigation canals by reducing their diameter or clogging the water courses. Due to sedimentation navigable streams and harbors start shoaling and can only be made navigable again by expensive dredging operations.

#### 4.5 Destruction of buildings, roads and other communication lines

Landslides and other forms of erosion are a very serious problem

in mountain areas. After a heavy rainfall often whole sections of a road rush down or are buried by soil masses. The same may happen to railways, telephone and power lines.

Villages and buildings situated on vulnerable spots are sometimes damaged by landslides, mud flow and avalanches of rubbles and boulders, very often causing casualties among the inhabitants. The high pressure on residential land forces more and more people to build their houses on steep slopes or other unsuitable land, where they are generally considered as squatters. With the high population growth, the pressure on residential land is likely to increase in future.

### Chapter 5:

#### PREVENTIVE MEASURE AGAINST EROSION

Indirect measures of erosion control are preventive by nature. In general it is much cheaper to prevent than to repair the damages of erosion. Prevention of damages is therefore the most important phase in erosion control.

### 5.1 Educational campaigns

As many people do not know the dangers of erosion, an educational campaign is the first step of erosion control. In such a campaign, age-old customs may have to be changed. There should be seminars for teachers in rural schools, who will impart their knowledge later to the children. Press, radio and television also play an important role in such a campaign. The Forestry Extension Department of the University of the Philippines is very active in this field and can give the necessary guidance and assistance.

### 5.2 Fire prevention and control

This is the most important preventive measure against erosion. Especially during the dry season a strict fire control must be organized and maintained. Regions with well pronounced wet and dry seasons are more endangered regarding fire and erosion than those with higher precipitations well distributed throughout the year. For more details see Part 2 of this book.

### 5.3 Fencing

If grazing and browsing are responsible for destroying the ground vegetation in an area of limited extent, suitable enclosures to avoid intrusion of livestock can be a good solution. The enclosure should not be too large in order to have a better control and not to inconvenience the local people, so as not to lose their cooperation.

### 5.4 Proper land use

Proper land use based on the capability of the land is very important in preventing erosion. In the Philippines land use in this connection is mainly regulated by the provisions of the Land Classification Law, which sets a maximum gradient for its main forms:

- For agricultural purposes only land with a gradient below 18 % can be released as alienable and disposable under certain conditions from the public domain.

- All land of the public domain 18% in slope and over is declared as permanent forest or forest reserve regardless of the condition of the vegetative cover.
- On suitable land up to a maximum gradient of 50% pasture leases or permits can be granted.
- Land with a gradient of over 50% can only be utilized for forestry.

It would be very important in this respect to decide also on a maximum gradient for commercial forests, above which the utilization of timber would have to be restricted. In extreme cases forests should have exclusively protective functions.

### 5.5 Proper range management

The term "range" is generally applied to a natural, non-irrigated grassland, which provides fodder for livestock or wild animals. The grassland can be a fire climax, naturally, or as the result of human activities. The term "forest range" refers to more or less open forest land used for grazing. Erosion can be minimized there by proper range management practices listed as follows:

- a) Prescribed burning: According to recommendations of the P.C.W.I.D. (PRESIDENTIAL COMMITTEE ON WOOD INDUSTRIES DEVELOPMENT), burning, if practiced at all, should be carried out under a permit system, that would require fire-free intervals of at least three years and a provision which prohibits the burning of more than 25% of the range unit in a single year.

If exercised at all, burning should be limited to the beginning of the dry season, when the fire would not be so very intensive. Until the beginning of the rainy season the ground would then have regained a cover of grasses protecting the surface.

- b) Pasture rotation: The pasture has to be subdivided into management units, which are successively grazed under a rest-rotation system. By this system overgrazing can easily be avoided.

- c) Pasture improvement: Up to now the Pasture Land Act prohibits the cultivation of the pasture permit area, and has prevented many good ranchers to introduce valuable fodder plants that require cultivation. A change of these regulations has been recommended by the P.C.W.I.D. Though pasture land can have a gradient of up to 50%, species requiring intensive cultivation can only be grown on suitable, less steep sites adopting careful soil conservation practices.

The following grass and legume species can be recommended for upgrading of pasture land provided that the principles of soil conservation are also taken into account:

- Grasses: Rhodes Grass (*Chloris gayana*),  
Dallis Grass (*Paspalum dilatatum*),  
Kikuyu Grass (*Pennisetum clandestinum*);
- Legumes: Hyacinth bean (*Dolichos lablab*),  
Kudzu (*Pueraria phaseoloides*),  
Centrosema (*Centrosema pubescens*),  
Perennial lespedeza (*Lepedeza cuneata*),  
Crotonia spp.,  
Ipil-ipil (*Leucaena leucocephala*).

#### 5.6 Restrictions on kaingin making

Since the kaingin system is the means of livelihood for about 120,000 families in the Philippines and a change is not likely to occur soon, we have to find means to prevent the damages caused to soil and water resources. The following possibilities exist:

- Resettlement of tribal minority groups and squatters in critical erosion areas to other areas classified as alienable and disposable (difficult for traditional tribal communities).
- Creation of employment opportunities to divert the people from kaingin making (e.g. reforestation).
- Continuing census of all occupants of the public forest and their approximate location to check new immigration into the area. All kaingineros entering the area after the census can be evicted according to R.A. 3701 (P.C.W.I.D., 1972).

- The kainginero is required to obtain a kaingin permit from the nearest representative of the BFD, who could impose restrictions depending on the case.
- No kaingin permit is to be issued for very steep slopes. The permit should contain an allowable maximum gradient, beyond which kaingin making shall be prohibited.
- No kaingin permit is to be issued for land adjacent to water courses. For water courses of 5 meters and over in width a strip of 50 meters of natural vegetation has to be left untouched on both sides.
- Kaingineros in forest reserves or permanent forest areas are required to adopt the taungya system (for details consult Part 2, Chapter 15 of this book).
- Strips of natural vegetation should be maintained between kaingins.
- The development of a permanent agriculture by terracing sloping land, by irrigation and by fertilizer and manure application has to be promoted wherever possible by the government agencies concerned.

#### 5.7 Restrictions on logging in critical areas

As mentioned in paragraph 5.4, no logging or any cutting of wood should be permitted above a certain gradient. Forests in those areas should be given only protective functions, because once destroyed they often cannot be replaced. The maximum allowable gradient for commercial forest depends on the erodibility of the soil, the vegetative cover and the climate. Extreme care is indicated in utilizing forests above settlements. The importance of forest protection along water courses has already been stressed.

In critical areas clear cutting must be generally avoided. Where the soil is less liable to erosion the area of the individual clear cut should be limited at least. From the view of soil conservation, careful selective logging is preferable to any clear cutting.

Careful logging practices must be enforced to protect the remaining vegetative cover. Skidding of logs is to be avoided,



while cableways should be kept narrow and logging debris must be prevented from clogging drainage canals.

### 5.8 Proper road construction and maintenance

Excessive erosion often starts along roads. The following points should be considered to prevent damage:

- Extensive earth movements in unstable or steep slopes must be avoided. The gradient of cuts and dumps should not exceed the natural angle of repose, which depends on the type of material:

|            |   |         |    |         |
|------------|---|---------|----|---------|
| fine sand  | - | 1 : 2   | to | 1 : 1.7 |
| loamy sand | - | 1 : 1.7 | to | 1 : 1.4 |
| loam, clay | - | 1 : 1.5 | to | 1 : 1   |

For dumps a lesser gradient is permitted than for cuts.

- On cut and fill slopes one has to establish an effective vegetative cover immediately after road construction (for details consult Chapter 9).
- Faulty drainage is often the cause of gully erosion washing away sections of the road. Particularly in slopes, a proper drainage is indispensable. To divert the water from its surface, the road has to have a camber or gradient against the hill side, where it is collected in ditches<sup>and</sup> conducted safely through culverts into stable waterways. The outlets of culverts must be made safe against erosion. Unstable gullies below culverts must be stabilized.
- Proper road maintenance, too, contributes to erosion prevention. It is essential, that the road surface is kept graded and sloped against the hillside to get the rain-water quickly off the road. Clogged ditches and culverts must be constantly cleared and kept open. Immediately after every typhoon there should be an inspection to repair the damages in their initial stages.

## Chapter 6:

### ELEMENTS OF ENGINEERING STRUCTURES

#### 6.1 Masonry

Masonry in a broad sense is employed for retaining walls and for the construction of weirs and checkdams. One can use natural stones, bricks or hollow blocks. Since the latter two are quite expensive, natural stones are most commonly used for masonry work in erosion control. The selected stones should be firm, not withered (so-called "dead rocks") compact, and without cracks. Stones originating from igneous rocks are generally more durable than those from sedimentary formations.

Masonry can consist of "dry" stone walls also called "riprapping" or stone walls built with mortar. Mortar is prepared by usually mixing clean, river sand (without loam and organic material) with cement at a ratio ranging from 1:3 to 1:5 depending on the purpose. Under natural conditions mortar hardens in a few hours, but it will obtain its full compressive strength only after approximately 3 to 4 weeks.

#### 6.2 Concrete

Concrete is used for the construction of retaining walls, weirs and for bank stabilization. For more stability concrete is often reinforced with steel bars. Gravel used in concrete should not contain stones of more than 7 cm diameter. The following tables give the proportions of the mixture and the quantity of cement required for concrete of different mixing ratios.

| Kind of concrete                             | Water content<br>(percent) | Cement            | Sand | Gravel |
|----------------------------------------------|----------------------------|-------------------|------|--------|
|                                              |                            | (ratio by weight) |      |        |
| Compressed concrete<br>for retaining walls   | 4-7                        | 1                 | : 2  | : 3    |
| Compressed concrete<br>for wing walls, weirs | 4-7                        | 1                 | : 2  | : 2    |

Table 4: Proportion of cement, sand and gravel in concrete mixtures.

| Ratio | kg Cement / cu. m concrete |
|-------|----------------------------|
| 1:1   | 900                        |
| 1:2   | 630                        |
| 1:3   | 460                        |
| 1:4   | 350                        |
| 1:5   | 300                        |
| 1:6   | 250                        |
| 1:7   | 225                        |
| 1:8   | 200                        |
| 1:9   | 175                        |
| 1:10  | 150                        |
| 1:12  | 125                        |

Table 5: Quantity of cement required for concrete of different mixing ratios.

Concrete reinforced with iron requires more water. Compressed concrete is processed by compacting layers of 15 to 20 cm, particularly the corners and edges of the concrete mass with a stamper. Special cements (so-called hydraulic cements) are employed for construction works in water. Ordinary concrete structures should not get in contact with water until completely hardened.

The disadvantage of masonry and concrete structures in anti-erosion works is that they are very inflexible. Once damaged, they are not easy to repair.

### 6.3 Gabions

is the term for large rectangular wire crates that are filled with stones and employed in erosion control techniques which have been developed in Italy. They have some significant advantages over solid structures:

- flexible : Gabiones bend without breaking, and in contrast to concrete or masonry with mortar do not crack. This can be an important aspect with regard to unevenly sinking foundations and the pressure in slopes.

- permeable : Gabion structures are permeable and do not need an extra drainage system.
- economical : Usually they are cheaper to construct than other solid engineering structures. They may become expensive only where stones are not available in sufficient quantity.

Gabions can be used in flowing water and for land reclamation along shores, for retaining walls, gully stabilization, etc.. They mainly serve as hydraulic structures.

- a) Construction: Since ready-made imported gabions are very expensive and hardly available, wire crates have to be constructed from locally available mesh wire. The wire should be heavily galvanized to insure a long life span. For stabilization and reclamation work in coastal waters plastic-coated wire is used for better protection against corrosion. The diameter of the wire should not be less than 2.5 mm; recommended are 2.8 or 3.0 mm. Gabions can be divided by so-called diaphragms to increase their stability and to prevent the internal movement of the stone fill.

For a gabion of 2 x 1 x 1 meter the following material is required:

- 1 piece of mesh wire 4 x 2 m = 8 sq. m,
- 2 pieces of mesh wire 1 x 1 m = 2 sq. m,
- 12 m iron rod 0.5-0.7 cm diameter,
- approximately 10 m wire for sewing.

At first the 4 m piece of mesh wire is spread on the ground. Then, the two smaller pieces are connected with the main body one meter from either end as shown in fig. 8. To strengthen the gabione an iron rod is fixed around the edges of the main mesh wire body and tied together where its two ends meet. To steady the gabion during filling it would be also possible to use thin bamboo or wooden poles as a substitute, should funds be lacking to buy the iron rod. These poles should not be too thick, so as not to leave large hollows in the gabion after they have decayed.

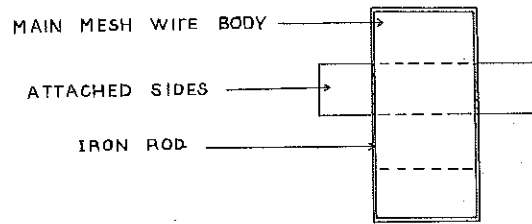

Fig. 7: Construction of a gabion

Gabions can also be manufactured from ordinary wire. The procedure requires some skill and experience and is described in detail by GUPTA and DALAL (1967).

b) Assembling of gabions: For better handling gabions are usually delivered flat-folded. On a level spot near the construction site they are opened, their sides folded up and the edges sewn together firmly with wire, which must be looped twice through every mesh opening along the edges. It should be as strong as the mesh wire of the gabion.

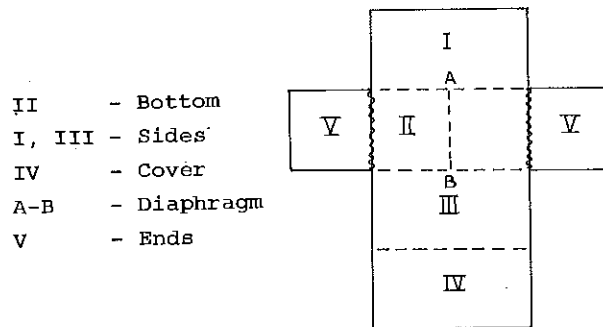

Fig. 8: Gabion opened

c) Filling: It must be observed that the gabion does not lose its shape. Therefore double strands of wire are stretched across the box and single wires tied diagonally at the edges. For better support these wires should be looped around at least two meshes (Fig. 9). Without the cross-ties the gabion tends to adopt the shape of a sausage.

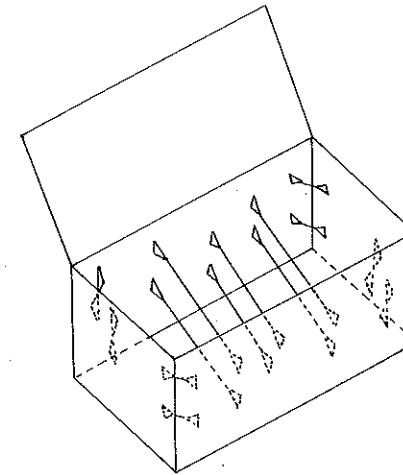
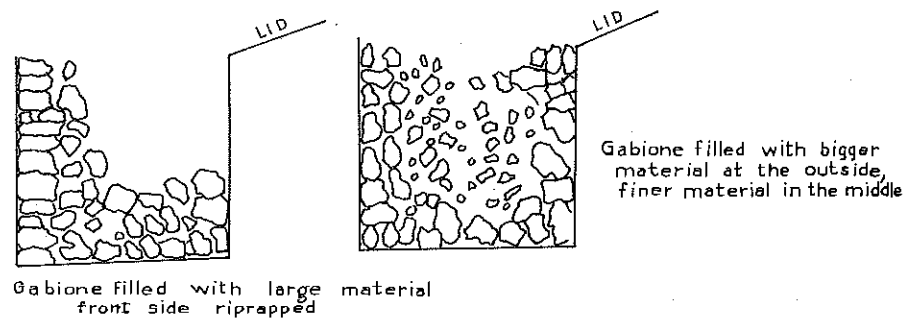

Fig. 9: Stabilization of a gabion by cross ties

The stones for the filling should be larger than the size of the meshes. The front of the gabion requires more riprapping, whereas for the back or inner side a rough filling may be sufficient. If there are not enough stones, the center can also be filled up with gravel (fig. 10).



Gabione filled with large material front side riprapped

Fig. 10: Filling of a gabion

After filling, the cover of the gabion is bent down, pulled tied with the help of a crowbar and sewn along the front edge and the sides. Most structures (retaining walls, check-dams, etc.) require several gabions, which are connected likewise by strong galvanized wire.

7.1 Plants for soil stabilization

Since<sup>a</sup> dense vegetation cover is the best protection against erosion, effective control techniques include to a large extent the use of living plants. Apart from being very effective vegetative measures of erosion control are very economical and are well within the scope of forestry work.

A single isolated plant can hardly prevent erosion, only the complete vegetation gives the desired protection. Whenever a vegetative cover is to be reestablished, the plants or cuttings must be set dense enough, or be able to close up quickly to form soon a protective blanket, which should consist of a mixture of trees, shrubs and some grasses.

In general, practically all plants are useful for a protective cover. However, plants to be used for erosion control should meet one or more of the following requirements:

- Ability to grow on degraded and eroded sites;
- Rapid development of the roots and the parts above-ground in order to provide the required protection very soon;
- Deep and widespread root system for good anchorage in the subsoil. But also a dense shallow root system can nevertheless have a favorable "matting effect";
- Dense and wide-spreading crowns to form soon a close canopy;
- Ease of establishment, preferably by cuttings, stumps or bare root seedlings. For live structures only species can be employed that sprout easily from cuttings;
- High production of litter to improve the site. Some species, especially legumes, are in a position to add considerable quantities of nitrogen to the soil through symbiosis with nitrogen-fixing bacteria;

- Ability to withstand the physical stress of falling stones and soil avalanches;
- Ability to survive when temporarily submerged. This is an important requirement for species to be used in stream bank stabilization. In addition, such species must be flexible without breaking in a strong current.

Suitable plants should be selected among the local species growing most vigorously in the area by considering the above-mentioned quality specifications. It is quite possible to use even species, which have never been cultivated before, but offer desirable characteristics.

In temperate zones willows (Salix spp.) are the standard species used in erosion control. This genus is represented in the tropics for example by Salix tetrasperma in Southern Asia and Salix humboldtiana in South America. Both species have not yet been tested in the Philippines.

Some promising species growing in the Philippines are listed below. Many of them have been tested already successfully in slope and bank stabilization.

a) Trees:

- Japanese alder (Alnus maritima): Very suitable fast growing species for medium and high elevations with strong root system and dense crown, root nodules with nitrogen-fixing bacteria; capable of improving degraded soils; unsuitable for dry sites.
- Ipil-ipil (Leucaena leucocephala): Can be propagated by cuttings; nitrogen-fixing bacteria; suitable for lowland sites, where it replaces Alnus maritima in mixture with other species.
- Madre de Cacao (Gliricidia sepium): Propagation by cuttings; nitrogen-fixing bacteria; grows on dry sites; together with ipil-ipil a very useful species for anti-erosion work in low elevations.
- Tibig (Ficus nota): A useful tree for gully and bank stabilization; deep and widespread root system; in the beginning slow growing; only for moist sites.
- Paper mulberry (Broussonetia papyrifera): For higher elevations; propagation by cuttings.
- Benguet pine (Pinus insularis): Has quite a deep root system, but does not form a dense canopy; in mixture with other species suitable for higher elevations.

- Kamachile (*Pithecolobium dulce*): Very dense and deep reaching root system; modest soil requirements; excellent for gully and bank stabilization in lower altitudes.

#### b) Shrubs:

- Guava (*Psidium guava*): Very modest soil requirements, able to grow on practically all sites; very dense and widespread root system.
- Lantana camara: Quite adaptable even to poor sites, deep root system, propagation by cuttings.
- Nauclea spp.: A shrub growing on the driest sites, even in clefts of rocks on southern slopes; seed ripens in March/April; frequent in the Binga/Ambuklao area.
- Trompet Tree (*Datura alba*): More of a shrub than a tree; fast growing, poisonous; propagation by cuttings; for medium and high elevations only.
- Mexican Sunflower (*Helianthus tuberosus*): Forms shrubs with lignified stems; sprouts easily and grows rapidly; the most useful brush species for biological engineering in the medium and higher elevations.
- Dumanay (*Homonoia riparia*): A medium-sized shrub found in the beds of creeks and streams or along their banks; useful for river bank stabilization, survives flooding; slow growth; propagation by cuttings.
- Maguey (*Agave cantala*): Very draught resistant, provides cover for degraded soils; propagation by suckers or the viviparous embryos of the inflorescence (bulbils).

#### c) Vines:

- Kudzu (*Pueraria thunbergiana*, syn. *P. hirsuta*): For erosion control this species is considered the best of all the kudzus; propagation mainly by cuttings, because seed production is generally low; perennial.
- Pueraria phaseoloides (syn. *P. javanica*): is more used as a fodder plant and for lower elevations; perennial.
- Centrosema (*C. pubescens*): A fast growing vine; shade resistant, perennial and quite tolerant of dry sites.
- Perennial lespedeza (*Lespedeza cuneata*): An excellent cover plant, even on badly eroded sites; draught resistant.
- Lipai (*Mucuna nigricans*): A perennial vine thriving well on dry sites; seed can be collected in February/March; the leaves are very itchy.

#### d) Bamboos:

- Kawayan (*Bambusa spinosa*): spiny bamboo, up to 25 m high.
- Kawayan - kiling (*Bambusa vulgaris*): smaller than kawayan.
- Boho (*Schizostachyum lumampao*): up to 10 m high, very common.

#### e) Grasses:

- Weeping Love Grass (*Eragrostis curvula*): This species has been introduced from Southern Africa to other tropical countries with a well pronounced wet and dry season; it is widely used for erosion control in Japan and Taiwan, particularly for hydro-seeding; an advantage is that this grass does not dry up completely during the dry season.
- Bermuda Grass (*Cynodon dactylon*): Equally suitable for dry and moist sites; stolon-forming, excellent soil cover particularly for banks and waterways; propagation usually by planting stolons or by sodding.
- Kikuyu Grass (*Pennisetum clandestinum*): As a native of the highlands of East Africa this stolon-forming grass can only thrive under somewhat moist conditions; the species has a dense root system and be propagated by planting stolons or small sods; widely used for erosion control in Taiwan.

There are other species of trees, shrubs, vines and grasses that can be selected from the local flora. Especially the pioneer vegetation during the first stages of the succession on abandoned kaingins, fresh landslides etc. may contain a number of suitable plants for erosion control with a wide ecological amplitude.

#### 7.2 Preparation of cuttings

Cuttings of different sizes are indispensable in biological engineering. They can be of different length and can be planted vertically or in a more slanting position. Experiments have shown, that a strong cutting planted in an almost horizontal position (Fig. 11) gives the best result.

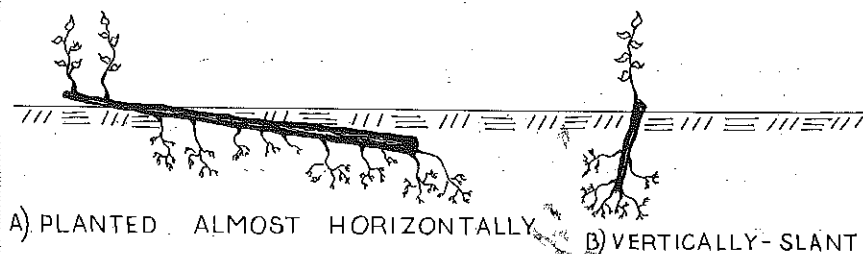

Fig. 11: The development of cuttings

The cuttings must be planted deep enough in the soil. At least three quarters of the length should be covered by soil, on drier sites better four fifth. If too much of the cutting is exposed, it is liable to dry out. Cuttings must be absolutely fresh when planted. Therefore the following rules should be strictly observed:

- Cut the brush wood just before it is used.
- Remove all leaves and unlignified shoots after cutting. For sunflower remove only 15-25 cm of the soft tip.
- Transport the material uncut to the construction site. Protect it with leaves against drying up.
- When possible store the material in water or at least under shade. Cover it with leaves and sprinkle it with water from time to time.
- Prepare the cuttings just before planting.
- Use healthy material only.

Biological engineering requires large quantities of brush wood. Where there are supply difficulties, it is recommended to establish a special nursery with multiplication beds to meet the demand. The output of brushwood can be increased by fertilizer application and irrigation, if required.

### 7.3 Grass sods

Grass sods are not often used in erosion control. They are obtained from sites with a dense grass cover. Grass sods are usually 4 to 7 cm thick and cut in squares of approximately 30 by 30 cm or larger. Sometimes they are prepared in strips with a width of 25 to 30 cm. For better handling and to avoid drying up the strips are rolled. It must be avoided that the sods dry up during transport and storage.

### 7.4 Bitumen emulsion

For stabilization of fresh road cuts bitumen is used as a 25% emulsion, which means that the commercial 50% emulsion has to be mixed with water at a ratio of 1:1. Bitumen

emulsion, which is a by-product of crude oil processing, is also called "cold asphalt". Its ingredients are bitumen, water and an emulsifier. Coal tar cannot be used in soil stabilization because of its toxicity to plants.

### 7.5 Anchoring pegs

Wood used in biological engineering should have the necessary durability to withstand decay long enough until the vegetation is well established. This is of particular importance on moist sites, in gullies and along river banks, where the wood may be subjected to frequent wetting and drying. The use of wood preservatives is generally out of question.

Pegs used in live structures should have a diameter of not less than 6 cm. They must be driven in deep enough and should still respond under the last stroke. This means that the peg moves deeper at least 1 to 2 cm under the last stroke without vibration or springing back. If the peg hits a stone or other obstacle, it will not get the necessary mooring. In that case another spot nearby has to be tried. Pegs can be driven in either vertical or perpendicular to the slope. The first is easier, the second provides a better anchorage.

Pegs can also be made from sprouting material, so that they will take roots. In that case the top, which generally is damaged by hammering, has to be sawn off.

Hooked pegs for "nailing" are made of forked branches. As their polarity will be changed, sprouting cannot be expected.

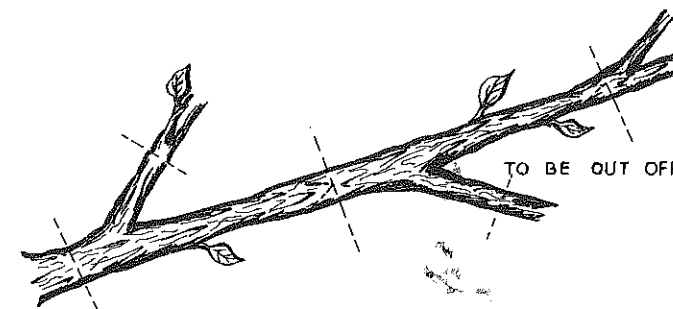

Fig. 12: Preparation of "hooked" pegs

Pegs are driven into the ground preferably with a mallet or wooden hammer (weight about 3 kg) instead of a sledge hammer, because the impact of steel on wood may destroy the tops of the pegs.

## Chapter 8:

### PREPARATION OF SLOPE STABILIZATION SITES AND LAYOUT OF DRAINAGE

Before starting the actual soil stabilization work by either live or combined structures, some preparations are indispensable. These preparations may be more time consuming and expensive than the stabilization work itself.

#### 8.1 Preparations

All loose big stones and boulders must be removed from the slope surface. If they roll down later, they cause damage in the already established structures. All suitable stones are collected for riprapping the most vulnerable spots. Then, all grates and ridges are smoothed or levelled and rills and gullies filled up with soil, if necessary supported by riprapping. Large gullies have to be stabilized and may then become part of the drainage system.

Very important is a proper transition in the upper part of the slope. Most landslides tend to form a steep or almost vertical wall in the upper portion. If the soil is not carved off for a smooth transition, more soil will constantly break away in this area. Trees standing very close the edge and particularly those, whose roots are already partly exposed must be cut.

PORTION TO BE CARVED OFF

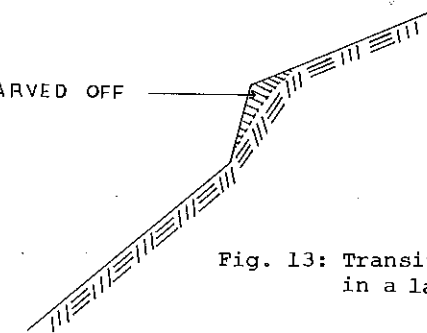

Fig. 13: Transition profile in a landslide

#### 8.2 Drainage

- a) Diversion canals: Their purpose is to prevent surface run-off from entering the area to be stabilized and to divert it into stable waterways without creating new gullies. However, they are only required, where one has to cope with high quantities of run-off.

If there are no stable natural waterways, one has to dig a trench and stabilize it with tar paper, old barrels cut in halves, grass sods, riprap, fascines or the like. These canals should have a trapezoidal cross section with the sides sloping 1:1. Often, a stabilized gully is made part of the drainage system (see Chapter 11).

- b) Subsoil drainage on slopes can be achieved by culverts or closed conduits laid out in trenches 30 to 80 cm deep and 30 to 40 cm wide. They must decline towards the outlet for better flow. There are several drainage types depending on the conditions and the availability of material.

- Tile drainage or pipe closed conduit: On the bottom of the trench permeable or impermeable earthenware or concrete pipes are placed in a continuous line and covered with sand or gravel. Water enters the pipes through the joints, or in case of permeable pipes through the pores.

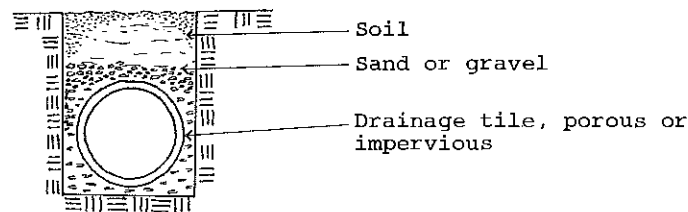

Fig. 14: Tile drainage

- Rubble drain: This is a more economical method as the trench is filled with gravel and stones, which may be available on the spot and need not to be bought. If filled up completely with gravel, these rubble drains can also intercept surface run-off.

- Stone closed conduit: To increase the run-off diameter and to cope with higher quantities of water a stone closed conduit can be constructed, which requires large flat or platy stones (see fig. 15). On steeper slopes a more riprapped filling is advisable to increase the stability. Another possibility would be the mesh wire cylinder closed conduit.

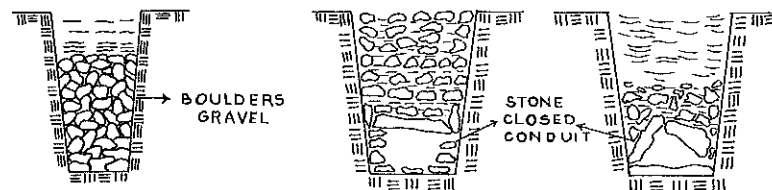

Fig. 15: Rubble drainage and stone closed conduit

- Temporary drainage: In the absence of stones or tiles also less durable materials as poles, boards and fascines can be employed in a temporary drainage. For details of construction see fig. 16.

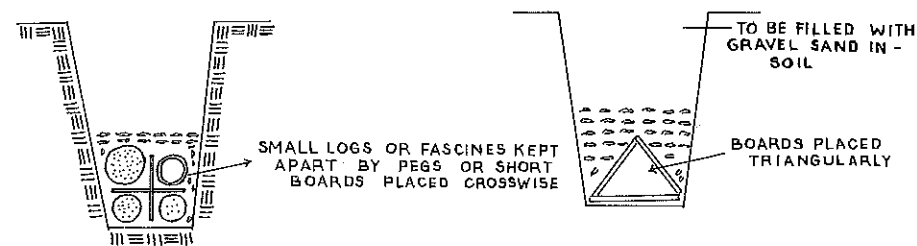

Fig. 16: Temporary drainage

Culverts are laid out with a slight gradient along the contours with an outlet into a stable waterway. More common, however, is a diagonal or vertical layout; sometimes y-shaped culverts are constructed.

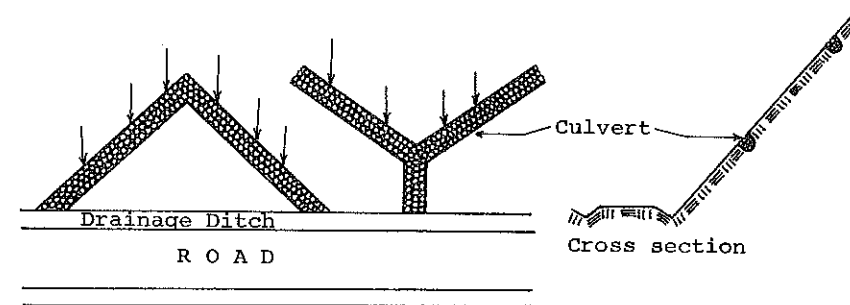

Fig. 17: Drainage layout in a road cut

c) Terracing for better drainage: For the stabilization of longer slopes, terraces 10 to 30 meters apart depending on the gradient have been found quite helpful in reducing erosion damages. They should be 1 to 2 m wide and laid out along the contour with a slight inclination towards the slope. Furthermore, the terraces must have a slight gradient towards a stabilized waterway to conduct the intercepted surface run-off safely into the general drainage system. One can use them as paths when working in the slope.



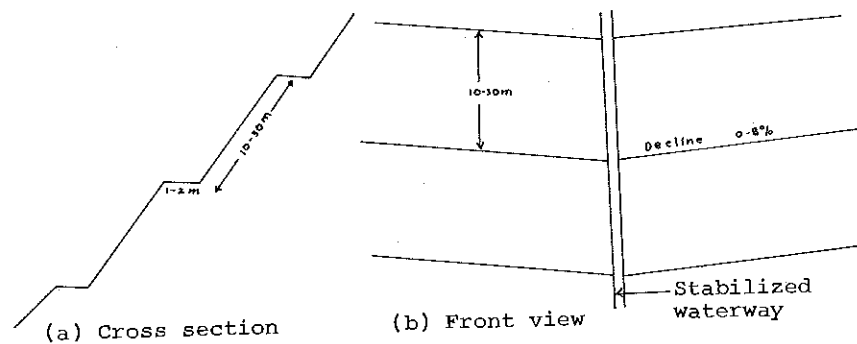

Fig. 18: Drainage on a terraced slope

When the preparatory work is finished and the question of drainage has been solved, which is of special importance in long slopes, the actual stabilization work with seedlings, cuttings or brushwood can start.

## Chapter 9:

### VEGETATIVE METHODS OF SLOPE STABILIZATION

In erosion control there is generally the choice between vegetative measures and solid structures of stone and concrete, or a combination of both. In this book emphasis is more on vegetative measures, because they are

- widely applicable and adaptable,
- economical,
- effective,
- as durable as concrete if properly done and maintained,
- easy to repair,
- in harmony with the natural environment.

It must, however, be kept in mind that purely biological measures have their limitations on very steep slopes, where only solid structures may provide the desired protection and stability.

#### 9.1 Planting and sowing

On slopes with more stable soils and a lesser gradient, an ordinary plantation may be sufficient to hold the soil in place. However, depending on the erodibility of the site, spacing must be closer than in conventional plantations. An average spacing of 0.6 to 1.0 meter would be adequate for most cases.

To avoid surface erosion around the seedling, the planting plots should have a decline against the hill. Mulching is also important.

The species selected should meet one or more of the requirements listed in Chapter 7.1. Since it may not be possible to find a species having all those desirable characteristics, one generally has to decide on a mixture of trees, shrubs and grasses whose components are complementary in one or the other respect. Planting is done in groups and clusters, intimate or single tree mixtures are to be avoided.

It may not be possible to reclaim completely degraded areas with one generation of trees alone. Often a less demanding, but site improving nurse crop is planted ahead. Afterwards more valuable, but generally also more demanding species are introduced by under- or interplanting, when the site conditions have improved. A species often used as a nurse crop is ipil-ipil (*Leucaena leucocephala*), under certain conditions also pines may be useful.

In semi-arid areas seedlings are often planted along contour trenches, which are like narrow terraces sloping slightly against the hill. Their objective is to intercept surface run-off and promote infiltration of the scarce rain water. The method, however, cannot be recommended for high rainfall areas like the Philippines.

## 9.2 Brush cover (German "Spreitlage")

This method, which in English is also known as "matting" (BENNET, 1955), has quite a number of modifications.

### a) Required materials and tools:

- Materials: Sprouting brushwood; pegs, sprouting or not, 60-80 cm long; wire, gauge 2 mm.
- Tools: Sledge hammer, or mallet, (wooden hammer)<sup>ca. 3 kg</sup>, bolos or pruners; a pair of pliers; shovels or spades.

### b) Method of construction:

At first pegs, about 60 to 80 cm long, are prepared and driven in about 20 cm deep in lines along the contour; distance within the lines about 1 meter, between the lines 1 to 2 meters, depending on the gradient of the slope and the length of the brushwood. Then the brushwood is spread with the butt end pointing downslope without leaving any uncovered spots. Afterwards, the pegs are horizontally connected by wire and further driven in, which presses the brushwood firmly to the ground. It may be necessary to cut some notches at the end of pegs to prevent the wires from slipping off.

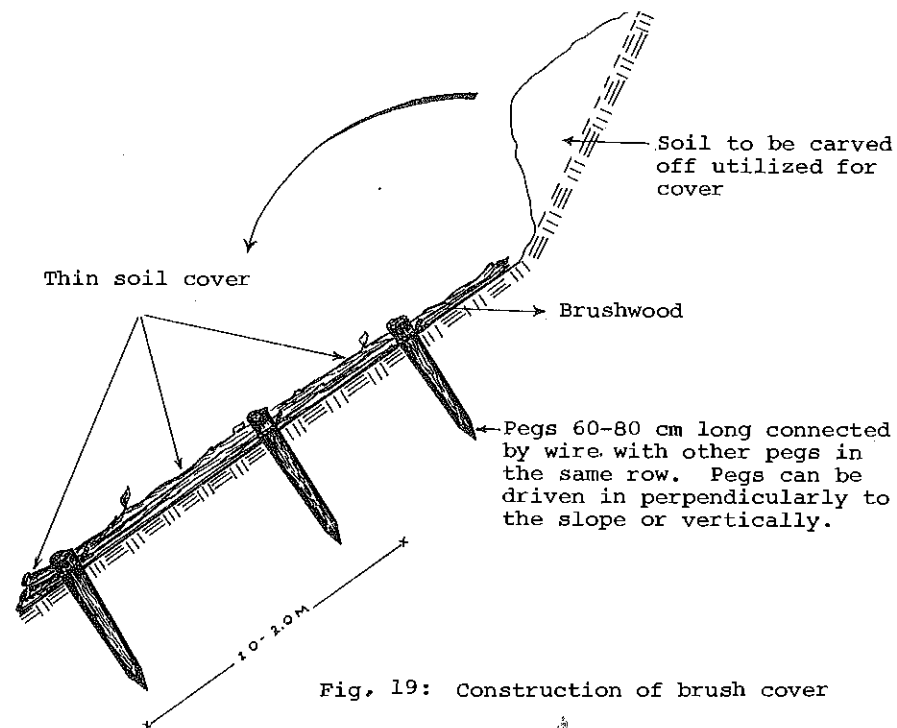

Fig. 19: Construction of brush cover

On steep slopes, it is sometimes difficult to keep the brushwood in place before installing the wires. There are two techniques to facilitate the work:

- The pegs can be connected before the brushwood is spread, so that the wire keeps the rods in place. Later the pegs are driven in deeper so as to press the brushwood firmly to the ground.

- Along the bottom of the line a fascine or a low wattling structure can be placed to prevent the brushwood from sliding downhill (Fig. 20).

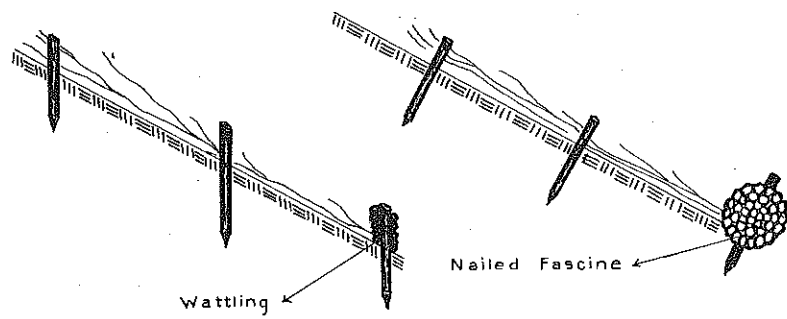

Fig. 20: Methods to hold the brushwood in place during the construction

Finally the matting is partially covered with soil, leaving about 40 to 50 percent of the brushwood exposed. The covered parts will develop roots and the exposed portions will sprout. The soil needed for the cover can be taken from the upper steep portion of the slope, where a proper transition profile has to be created anyhow. If this is not done properly, erosion will continue in that upper portion (See fig. 13).

If soil from above is not sufficient or not available, it has to be hauled from a nearby place. Without a soil cover this method would almost always result in failure.

If wire is not available for connecting the pegs, it can be substituted in the following way:

- Split bamboo. This material is quite flexible, but not as strong and durable as wire.
- The brushwood can be held in place by long poles nailed to the ground by hooked pegs.
- The brushwood can also be pressed to the ground by a wattle as illustrated in fig. 20, which in addition will hold the soil cover in place. The material for this kind of wattling need not to be sprouting as it is only partially covered and liable to dry out anyhow. The distance between

the pegs within the row and between the rows should be rather narrow to compensate for the lesser strength of this structure.

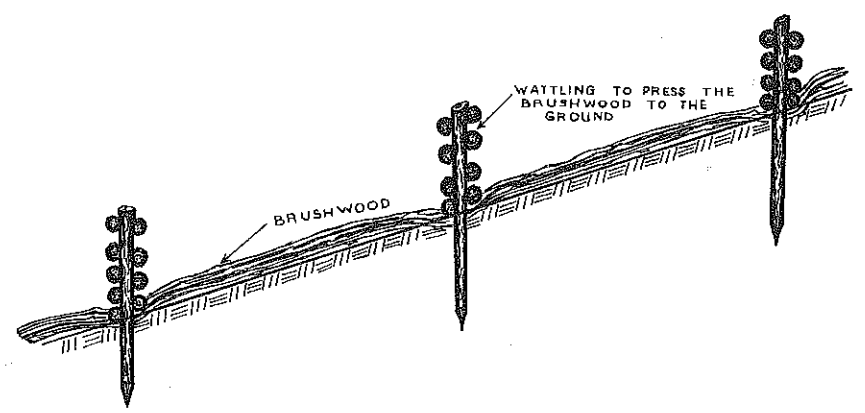

Fig. 21: Instead of using wire the brushwood is kept in place by wattling

To provide better growing conditions particularly on dry sites, the brush cover should be mulched with grass or leaves. Immediate fertilizer application after the construction is not recommended as the fertilizer may be washed out before the roots are developed.

Several modifications of the brush cover method have been worked out:

- Modification 1: To economize with brushwood, it is also possible to cover only portions of the slope in strips or bands, which should follow the contour. Between these bands, which are called "mattresses", seedlings or cuttings are planted (Fig. 22).

Their width should be between one and two meters. The distance between the mattresses depends on the steepness and the erodibility of the slope. On very erodible slopes they are constructed in shallow trenches about 15 cm deep. In this case we speak of "sunk mattresses" (Fig. 23).

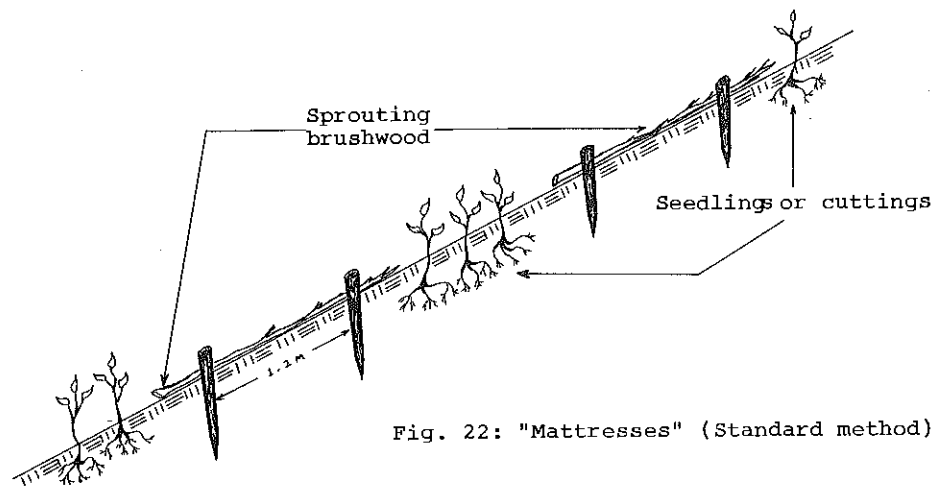

Fig. 22: "Mattresses" (Standard method)

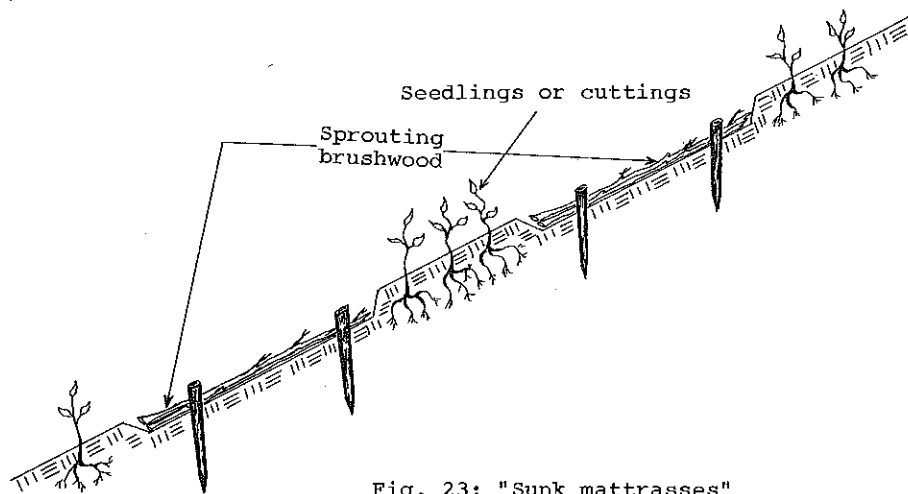

Fig. 23: "Sunk mattresses"

- Modification 2: In the absence of sprouting material, any kind of available brushwood, even dead branches can be used as a soil cover. The brushwood is tied to the slope in the same way as described above. Afterwards cuttings are planted densely through the brush cover. A soil cover is not required. This method is also called "dry brush cover", which can also be constructed in the form of a mattress.

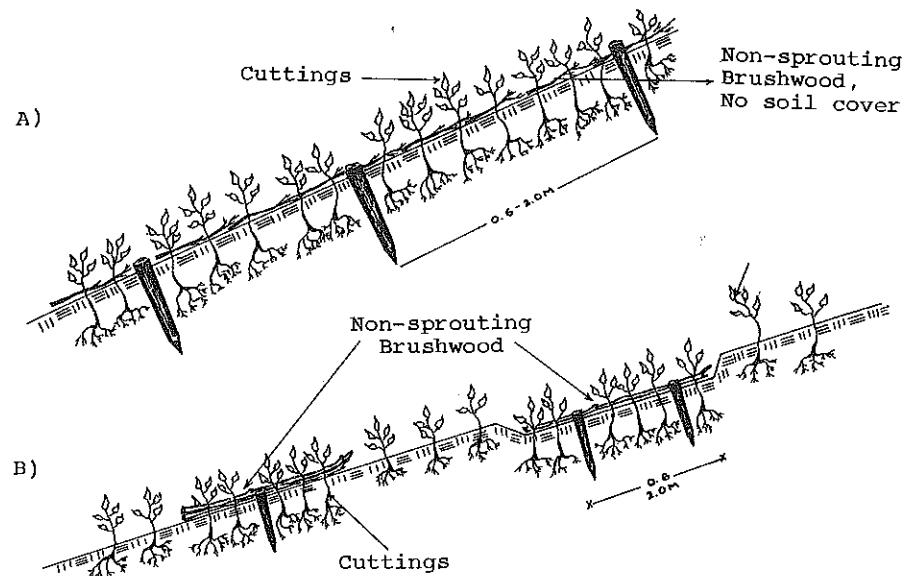

Fig. 24: (a) Ordinary dry brush cover, (b) dry brush cover as mattresses

c) Advantages and disadvantages:

- Advantages: The brush cover is probably the most stable of all live structures. Immediately after the construction it will resist almost all stresses of erosion. Therefore, it can be recommended for steep slopes, unstable soils, and for regions with a high rainfall intensity (typhoon belt). Due to the cover of soil and mulching material it does not dry out easily.
- Disadvantages: A disadvantage of this method is the high quantity of brushwood and labor required. To economize, the mattress modification may be given preference.

9.3 Bench brush layers (French: Cordon, German: Buschlage)

This method is very old and common in Central Europe. It was originally developed in France, but later improved in Austria and Germany.

a) Required tools and materials:

- Materials: Sprouting brushwood in pieces of at least 0.8 meters length; for modifications tall seedlings; fertilizer, if available.
- Tools: Hoes, spades or shovels, bolos or pruners.

b) Method of construction:

In contrast to the brush cover method and other slope stabilization methods, the work for the bench brush layers begins at the base of the slope and proceeds uphill. At the base of the slope, the first bench is dug with a depth of 50 - 120 cm with an inward inclination of about  $25^{\circ}$ . The brushwood is spread on the benches with the butt ends pointing inwards. For better anchorage the branches should be placed crosswise. Branchy and forked brushwood serves the purpose better than straight rods. The excavated soil from the next upper bench is used to cover the brushwood. This is the reason why the work has to start at the base of the slope. After refilling, the soil is carefully tamped. Fertilizer is applied by broadcasting before refilling the benches.

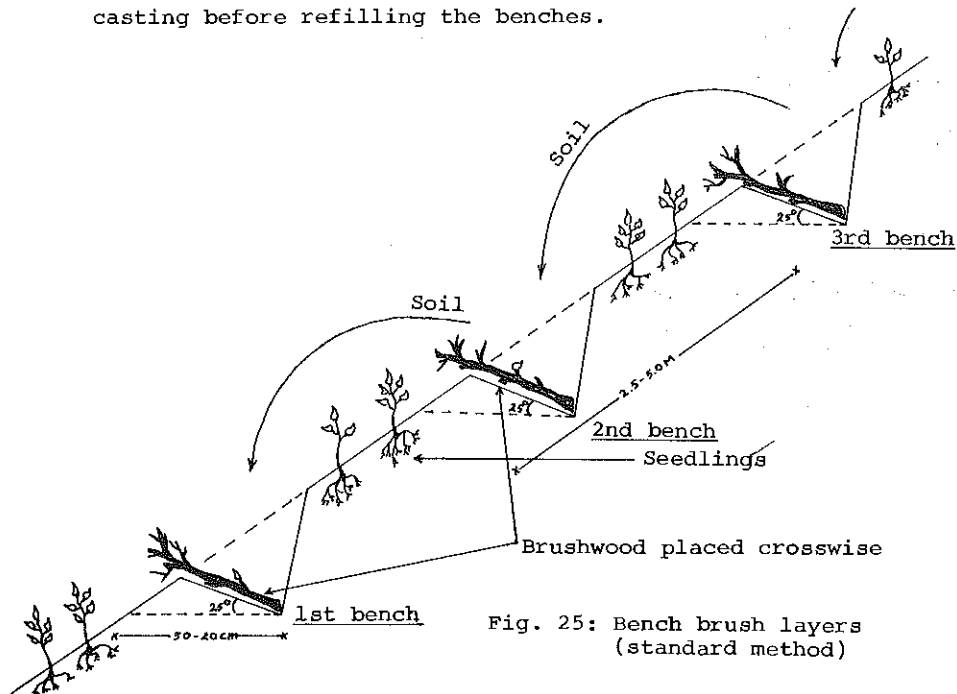

Fig. 25: Bench brush layers (standard method)

The distance between the benches depends on the gradient of the slope and the stability of the soil, and may vary between 2.5 and 5.0 meters. The average distance may be around 3 meters. If the benches are constructed too close to each other, there is the danger that the soil will give way before the whole system is well established.

Cordons can be constructed in long continuous benches along the contour or, in more unstable soils, intermittently.

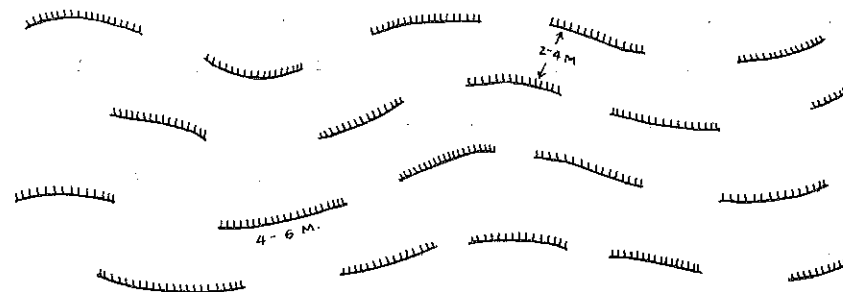

Fig. 26: Bench brush layers or cordons established intermittently along the contour

Between the benches, cuttings or seedlings are planted at a close spacing (0.6 to 1.0 m). To obtain different rooting horizons, it is recommended to use a mixture of different species. Even shorter brushwood, can be utilized if mixed with longer branches, as long as about 10 to 20 cm of the tips are not covered with soil.

To avoid drying out particularly on southern slopes, the whole area and the top ends of the brushwood should be covered with a mulch of grass or leaves.

Also this method has a number of modifications:

- Modification 1: The brushwood is mixed with tall seedlings or even saplings of species which normally would not sprout as cuttings. Many species have the ability to develop a secondary root system above the original root collar, which may help to keep the soil in place. Although planted almost horizontally, the seedlings will adopt a vertical position later. This modification is called "mixed brush layers"

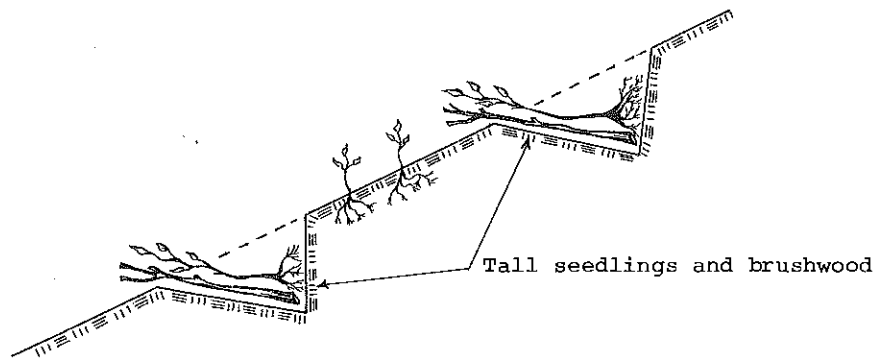

Fig. 27: Brushwood mixed with tall seedlings or saplings

- Modification 2 adopts elements of the brush cover method by using pegs and wire to fasten the brushwood to the benches, which are also covered by soil afterwards. Through the pegs and wire the structure gains additional strength, which may be necessary for more unstable soils (Fig. 28). Rarely used.

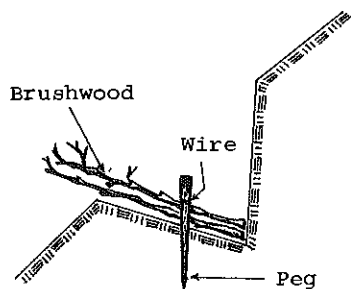

Fig. 28: Cordon with pegs and wire

- Modification 3 is designed for the stabilization of dumps and larger road fills. The stabilization work is carried out simultaneously with the dumping of soil. After dumping the first layer of soil, brushwood of 2-4 meter is laid out crosswise. Then the next layer of soil is dumped leaving about one fourth of the brushwood exposed. The dumped soil must be well compacted with a stamper or, if available, with a vibration compacter. The vertical distance

between the brushwood should be approximately 2 meters, narrower in sandy soils, wider in loamy soils. The brushwood can also be mixed with tall seedlings.

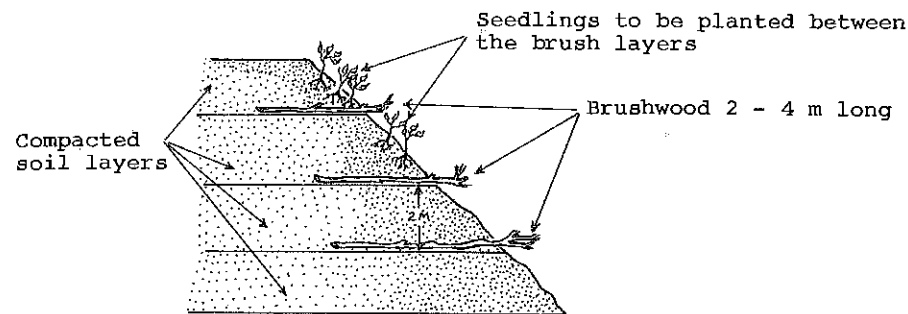

Fig. 29: Stabilization of dumps

Where rocks prevail, it is advisable to cover the brushwood first with a thin layer of topsoil for a good start. On very erodible soils, the uncovered portion between the brush layers can be protected by a brush cover or by applying the bitumen emulsion method. In any case, the slope has to be further stabilized by planting seedlings or cuttings. With this modification, large road fills along superhighways in the Austrian Alps have been stabilized in a very effective and economical way. This method may also be suitable to stabilize dumps of mining waste.

- Modification 4: As this modification uses dry or non-sprouting brushwood, it can be called "dry brush layer". It has been developed for the refill of irregular cavities. The brushwood is used as a reinforcement for the refill consisting of soil and stones, and is placed in a way that the branchy tip points inwards and the butt ends are exposed. For further reinforcement, long pegs are driven in and connected by wire. Cuttings of sprouting species are planted to take over after the brushwood has decayed (Fig. 30).

This modification is quite useful for repairing smaller erosion damages on slopes and in gullies. If the construction is carried out during the dry season, cuttings can be brought in later during the planting season. Nevertheless, the protective effect is obtained right after the construction.

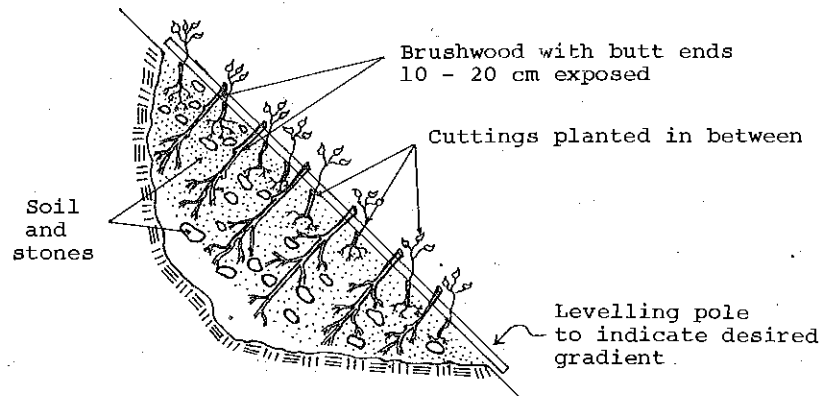

Fig. 30: The use of non-sprouting brushwood as described under modification 4

c) Advantages and disadvantages

- Advantages: The brushwood is well protected against drying out. Only a small quantity of brushwood, which can be of irregular form, is required. Besides brushwood and fertilizer, no other material is needed. The progress of the work is quite fast. Failures are relatively rare. This method is considered by European erosion control experts as one of the best and most economical.
- Disadvantages: Since the soil surface between the benches is not well protected as compared to the brush cover method, sheet and rill erosion can occur in the beginning. This could be reduced by covering the intervals between the benches with mulch after the seedlings have been planted. In loose and dumped soils which are not yet compact enough, digging the benches may cause small landslides. On those sites, brush covers should be given preference.

9.4 Wattling

a) Required tools and materials

- Materials: Pegs (70 to 90 cm long, diameter approximately 4-6 cm); rods, long, straight and flexible of a sprouting species; cuttings, 40 to 60 cm long.
- Tools: Bolos or strong pruning shears; big hammer or mallet (wooden hammer); planting hoes, shovels and a crowbar.

b) Method of construction: Wattling consists of interwoven fences of brushwood in shallow trenches. In a shallow trench approximately 25 cm deep, pegs are driven in 50 to 70 cm apart, between which straight rods of sprouting species like sunflower, ipil-ipil, kakawati are woven. The rods must be interwoven in a way that the butt ends are bent down into the soil (or will be covered by soil) and their upper portions exposed (Fig. 31 c). It is also possible to insert cuttings in the wattling structure (Fig. 31 b).

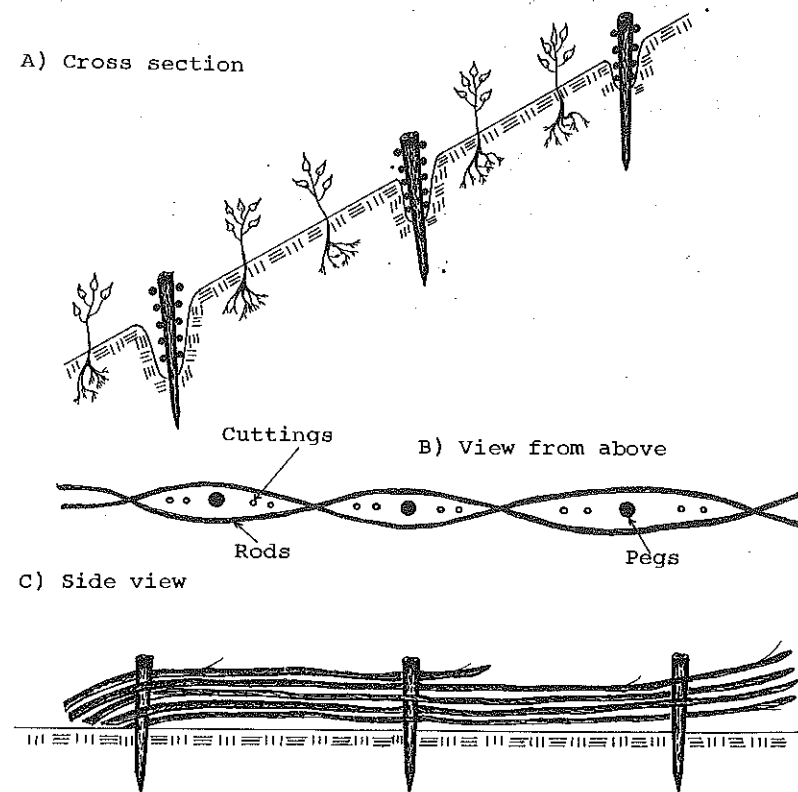

Fig. 31: Construction of sunk wattling

Finally, the trenches are refilled with the excavated soil, leaving the upper part of the wattling structure exposed. Before refilling the trenches, one can apply fertilizer. On sites with a southern exposure, a mulch cover will help to keep the moisture and favor sprouting.

Wattlings can be constructed in continuous lines or intermittently along the contour. Another technique is the so-called diagonal wattling with lines crossing the slope in a rhomboid pattern. This method is quite common for the stabilization of road cuts in Germany.

The distance between wattlings depends on the stability of the soil, but should not be less than 2 meters. The intervals can be planted with seedlings or cuttings of suitable species.

- Modification: Instead of using living branches, one can also use any kind of non-sprouting material. This modification is called "dry wattling". In this case, there is no need to observe the polarity of the rods or to have the butt ends covered with soil. The trenches can be much shallower.

A dry wattling does not depend for its construction on the rainy season. It can be constructed any time, but has to be planted with seedlings and cuttings during the planting season.

c) Advantages and disadvantages:

- Advantages: Due to the retaining ability of the wattlings, the soil is kept well in place. Protection is obtained usually right after the establishment. When constructed diagonally, wattlings are very stable and large erosion can hardly occur.
- Disadvantages: Only long straight and flexible rods can be used. If the structures are not buried deep enough, they may be washed out and damaged by surface runoff. The construction of wattlings in trenches is quite difficult. Since too much of the brushwood is generally exposed, sprouting may not be satisfactory.

9.5 Slope stabilization with fascines

The use of fascines for slope stabilization is not very common nowadays. Their main use lies more in river bank stabilization.

a) Required tools and materials:

- Materials: Brushwood of sprouting species, wire, hooked pegs.
- Tools: Hoes, shovels, hammer or mallet, bolos or pruners, axe, pair of pliers, and a bow saw.

- b) Bundling of fascines: Fascines are bundles of long and dense brushwood of varying length. For slope stabilization, the length of the fascines should not exceed 3 meters, otherwise they would become too heavy to handle as the weight of a fascine with a length of 1 meter and a diameter of 25 centimeter is 13 to 14 kilograms.

The bundles should form a straight cylinder. Top and butt ends must be arranged in a way to get a cylindrical shape, the polarity does not matter.

There are two methods of bundling:

- Guide frame: A guide frame is prepared by two parallel rows of pegs 35 cm apart. Pieces of wire 1 meter long are placed across on the ground before the brushwood is piled up. After filling, the brushwood is bundled. Finally, both ends of the fascine are trimmed (Fig. 32).

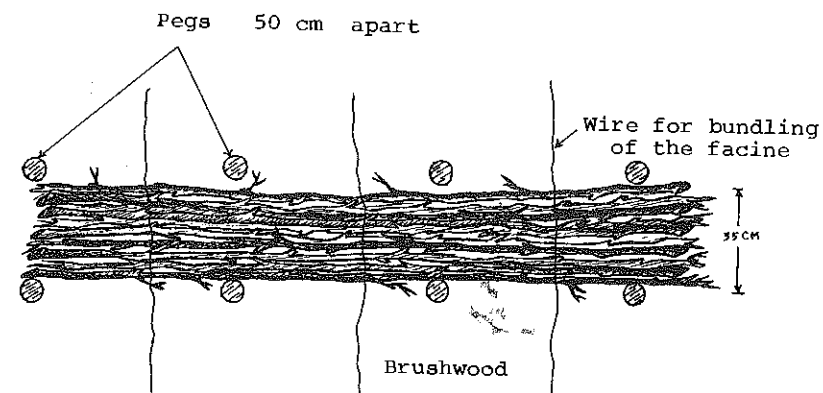

Fig. 32: Construction of a fascine



- Bundling press: For the manufacture of large numbers of fascines, the use of a "fagot binder's press" or "fagot bundling press" is recommended. The device looks similar to a saw buck and consists of poles driven crosswise in the ground as illustrated in fig. 33 and tied together by wire.

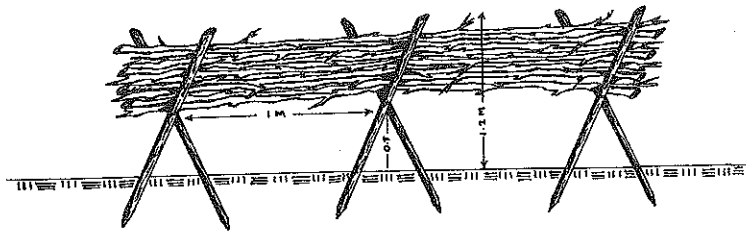

Fig. 33: Fagot bundling press

For bundling, the brushwood is compressed with a simple device called binding chain as illustrated in Fig. 34. The binding chain is placed below the bundle and both handles are first pressed upwards and then downwards. This work is done by two men, while a third person takes care of the wiring as the brushwood is compressed. Finally, both ends of the fascine are properly trimmed.

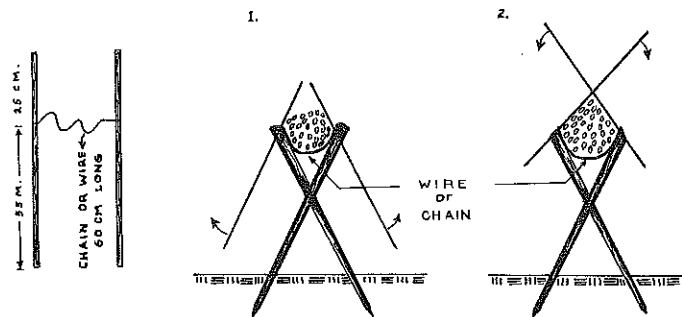

Fig. 34: Pressing of fascines with a binding chain

c) Method of construction: After the usual preparation, trenches with a depth of about  $\frac{1}{2}$  the diameter of the fascine are dug to prevent underscoring by surface run-off and drying out of the brushwood. The fascines are placed in the trench and "nailed" or anchored firmly in the ground with hooked pegs. The fascines can also be anchored by pegs driven in along both sides. The opposite pegs are connected by wire.

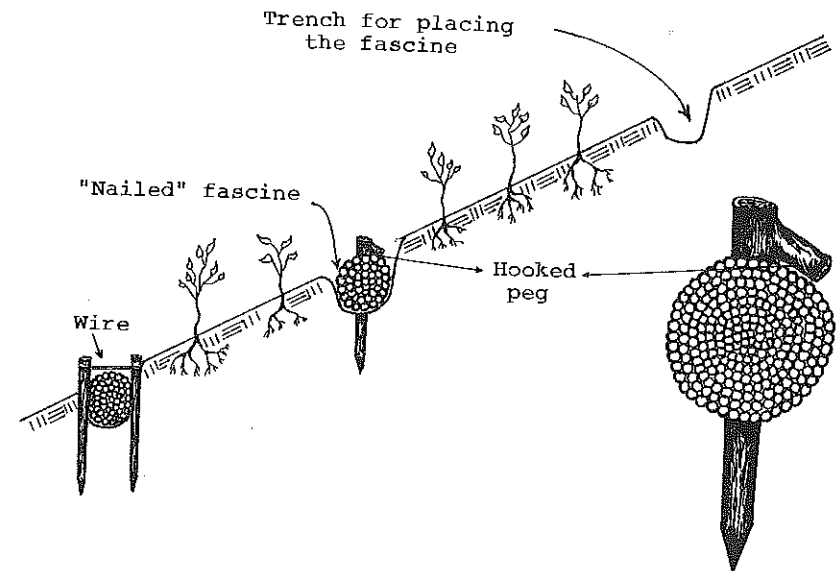

Fig. 35: Slope stabilization by fascines

After the fascines have been laid out and nailed, the trenches are filled with soil, and the fascines buried to about one half or two thirds of their diameter. Fertilizer application and a mulch cover would improve the growing conditions.

Fascines can be built in a continuous line or intermittently as described above. Also a diagonal layout is possible. The intervals between the rows depend mainly on the gradient. BERRY (1956) suggests the following intervals:

| Slope    | Interval between fascines<br>(surface distance)   | No. of fascines per 100 sq.m<br>(1.5 m long, 30 cm diam.) |
|----------|---------------------------------------------------|-----------------------------------------------------------|
| 0-10°    | Open brushwood supported by cuttings, no fascines |                                                           |
| 11-20°   | 3.00 m                                            | 20                                                        |
| 21-30°   | 1.50 m                                            | 36                                                        |
| 31-40°   | 1.20 m                                            | 47                                                        |
| 41-50°   | 1.00 m                                            | 51                                                        |
| over 50° | retaining walls                                   |                                                           |

Table 6: Intervals between fascines on slopes of different gradient (According to BERRY, 1956)

- Modification: If not enough sprouting brushwood is available, the fascines can be made of non-sprouting material. The brushwood should not have diameters over 5 centimeters. The method of construction is the same as described for the standard method. Protection is first achieved by the fascines. Later, when the fascines have decayed, the seedlings and cuttings planted in the intervals will take over.

#### c) Advantages and disadvantages

- Advantages of fascines: Very easy to establish, fast progress of work, relatively low cost. A mechanical protection is already obtained right after the establishment.
- Disadvantages: Fascines require large quantities of brushwood. They are liable to dry out, only a small portion of the brushwood will sprout, therefore "dry" fascines are to be preferred. But they are quite low and, therefore, hardly able to intercept much rolling material.

#### 9.6 Sodding

may sometimes be considered for the stabilization of small slopes particularly in residential areas. The difficulty in using this old and efficient method usually is the supply of a sufficient quantity of good quality sods.

Before placing the sods, the slope has to be well smoothed. The work starts at the base of the slope. It is essential that

the sods have a good contact with the soil. This is achieved by clapping the sods with a sod flap or a handy piece of wood. At last, a thin cover of good topsoil (and some fertilizer) is applied, and the sodding is watered thoroughly.

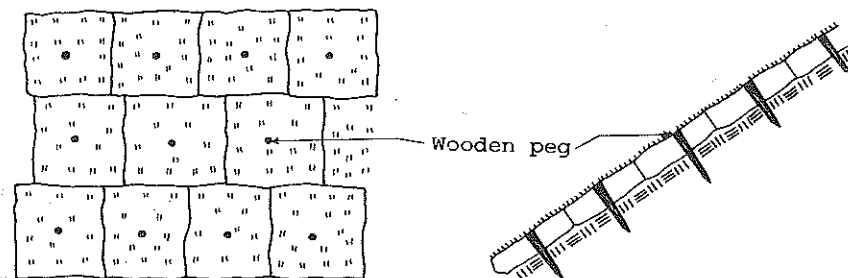

Fig. 36: "Nailing" of sods on a steep slope

On steep slopes and along river banks, the sods are kept in place by short wooden pegs 20-30 cm long, 2-3 cm thick. In river bank stabilization, the sods are sometimes covered by mesh wire. After completion, the sodding should not be stepped on for 3 to 4 weeks.

In very steep slopes with a gradient of over 45°, the sods are put in layers, either perpendicular to the slope or horizontally. Because of the high consumption of sods this modification is employed only in special cases, particularly for inlets or outlets of culverts.

The advantage of sodding is that the protection is obtained right after the establishment. It is, however, often difficult to obtain sods in sufficient quantity. The main application of this method is for landscaping, gardening purposes, and stream bank stabilization.

#### 9.7 Mulching and bitumen emulsion

In the original method developed in U.S.A. a mixture of bitumen, water, seed, fertilizer, chopped grass or straw and good topsoil were applied to the slope simultaneously in one operation with a powerful seeding gun mounted on a truck while a mixing device prevents sedimentation during spraying.

The bitumen acts as a kind of glue binding mulch, seeds, fertilizer and soil particles together. Evaporation from the soil surface is reduced, and an excellent micro-climate favors the germination of the seed. If the work has been successful, the vegetation soon forms a close blanket taking over the protection when the straw mulch starts to decompose. The method was modified in Europe, so that simple backsprayers could be used.

After the usual preparation like levelling and removal of loose stones, the slope is covered with grass or straw in full length or chopped in pieces of about 5 cm. The grass cover is thoroughly wetted by soaking before it is spread, or by sprinkling afterwards. On the grass mulch, a seed mixture is broadcast together with complete fertilizer. The quantity of seed required per square meter is 40 to 50 grams consisting of a suitable mixture of trees, shrubs, herbs and grasses. The same quantity of fertilizer is added.

Then the bitumen emulsion is applied with an ordinary sprayer, the same type as used for spraying insecticides. The quantity of bitumen emulsion (50 %) needed per square meter is about 0.25 liters mixed with the same quantity of water, so that finally a 25 % mixture is applied. Mixing the emulsion is done just before spraying to avoid coagulation and clogging of the sprayer nozzle. The commercial bitumen emulsion must be always stored in airtight containers to avoid hardening. Bitumen emulsion mixed with water must be used within one or two hours and cannot be stored longer.

During the work, the areas to be stabilized should not be stepped on. Therefore ladders must be used from which a strip 1.5 m wide can be covered; then they are moved to another strip. The work must be conducted during good weather, because it takes three to four hours for the emulsion to harden completely and to provide a stable coating. Rainfall after this time would not affect the work anymore.

#### 9.8 Slope stabilization by hydro-seeding

In another modification of the original mulching method, instead of bitumen emulsion a polymere dispersion, e.g. CURASOL is used. Sometimes small quantities of natrium alganate like AGRICOL are added (1-2 grams per square meter). The mixture consisting of seed, fertilizer, binder chemical, and sometimes mulching material is directly applied to the slope in one process with a special "hydro-seeder". In contrast to the original method this mixture does not contain soil. With extension hoses also spots in some distance from the road can be reached.

After spraying the water will evaporate or seep into the soil. The finely distributed particles will harden under mutual contact and bind the soil in a porous three-dimensional net-like pattern. The stability is determined by the quantity of material used. The depth of the soil which is stabilized depends mainly on the quantity of water added and how the diluted components of the mixture were absorbed by the soil.

This method has been successfully used in Japan for spraying inaccessible places from helicopters.

SOLID RETAINING WALLS AND COMBINED METHODS OF SLOPE STABILIZATION

Vegetative methods of slope stabilization have their limitations on slopes over  $50^\circ$ . If the slope is steeper, it requires solid retaining walls. But because of their high costs in material and labor, they should be limited to places where their construction is justified by their function.

For increased stability against pressure from the slope, the front must be slightly inclined, while the back is vertical. For different types of retaining walls the following inclination is recommended:

|                |   |                 |
|----------------|---|-----------------|
| dry stone wall | - | 1:1/3 to 1:1/4  |
| masonry        | - | 1:1/4 to 1:1/5  |
| concrete       | - | 1:1/5 to 1:1/20 |

The thickness of the wall on top depends on the material and the height of the wall. The following suggestions apply to retaining walls 1 meter high:

|                |   |             |
|----------------|---|-------------|
| dry stone wall | - | 0.50 meters |
| masonry        | - | 0.40 meters |
| concrete       | - | 0.30 meters |

Higher walls require greater thickness. The foundation must be deep enough to avoid sinking. As a rule of thumb, foundations of dry stone walls should have a width of about two thirds of the height. Since revetments are not so much exposed to the pressure of the slope and serve more to prevent a further weathering of rocks and of stable soils on steep slopes, they need not to have the same thickness as the retaining walls.

10.1 Riprap or dry stone walls

are a very common and traditional technique to stabilize terraces and steep slopes which are not too high. Sometimes riprap serves more as a revetment than as a retaining wall. A special drainage is not required, since riprap walls are self-draining.

In the construction, the joints are broken like in ordinary masonry. The largest stones are reserved for the foundation and the lower portions of the wall. It is important that after each layer of stones soil is filled behind and firmly compacted, otherwise the wall would collapse in the first heavy rainfall.

10.2 Retaining walls of concrete or masonry

are seldom used in forestry fieldwork. Their main function is to protect buildings or other valuable installations. Very important is a drainage within and behind the wall. This is generally achieved by piling stones and gravel behind the wall to absorb the pressure of the slope and collect the drainage water. To conduct the accumulated water through the wall, some drain pipes or holes ("weep holes") are built in.

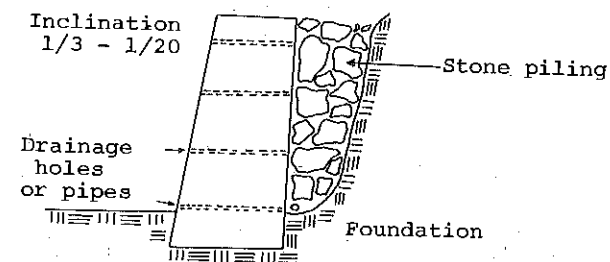

Fig. 37: Solid retaining wall with drainage holes and stone piling

### 10.3 Gabions for slope stabilization

are becoming more and more popular in Europe. For this purpose, the gabion elements can be combined in many different ways. It is possible to stabilize the base of a slope with only one row of gabions, or to arrange them in terrace formation as shown in fig. 38 b. Especially the first type of structure should always have a slight inclination towards the slope. In structures with a height of two or more elements, the gabion units must be solidly connected by wire.

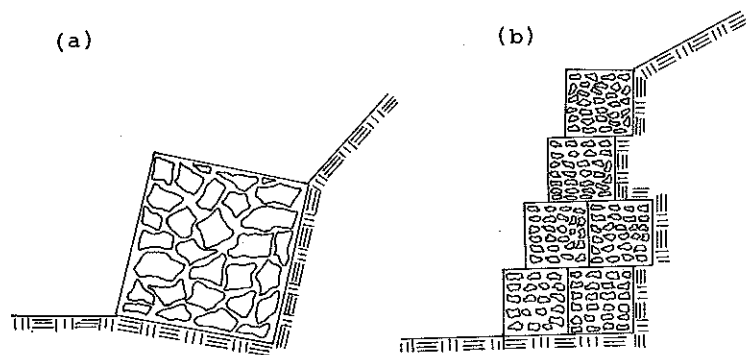

Fig. 38: a) Gabion with an inclination towards the slope;  
b) Gabions in terrace formation.

In the following, methods of slope stabilization are described that are a combination of plants, mainly cuttings, and a more or less durable structure. Very often the latter serves only to protect and keep the soil in place, until the vegetation is fully established. Sometimes the vegetation only reinforces or strengthens the solid structure.

### 10.4 Riprap interplanted with cuttings

Riprap retaining walls and revetments can be reinforced by interplanting them in the joints with cuttings of suitable species. The length of the cuttings depends on the thickness of the riprap. Planting must be deep enough to avoid drying up. Only 2-3 cm of the cuttings should be exposed outside the wall. Sometimes grasses are planted in the joints, especially in the stabilization of river banks.

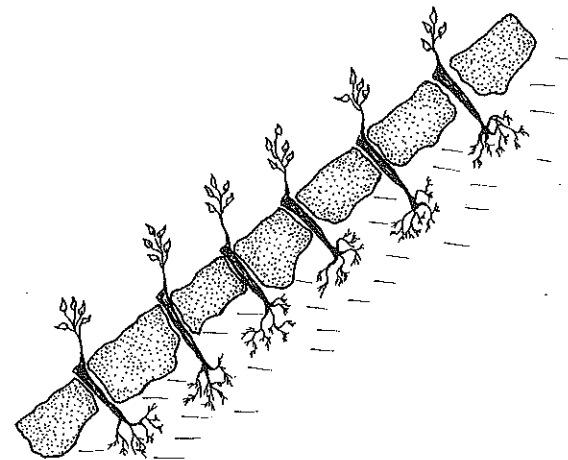

Fig. 39: Riprap interplanted with cuttings

### 10.5 Pole structure (German: Krainerwand)

Though expensive because of the high consumption of poles, this method may be of some value where stones are not available and an urgent stabilization is required.

For the construction one needs poles of sufficient length with a diameter of 10 to 15 cm. The first pole is placed lengthwise along the base. Then strong posts with a diameter not less than 12 cm are laid out perpendicular to the base pole 1 to 2 meters apart. In the intervals cuttings or seedlings are planted in a slanting position. The next pole is laid again lengthwise 10 to 15 cm inward on top of the perpendicular poles. The same procedure is repeated until the desired height is obtained. For better anchorage the

poles can be notched at the joints. If the construction takes place during the dry season, planting of cuttings can follow during the next rainy season.

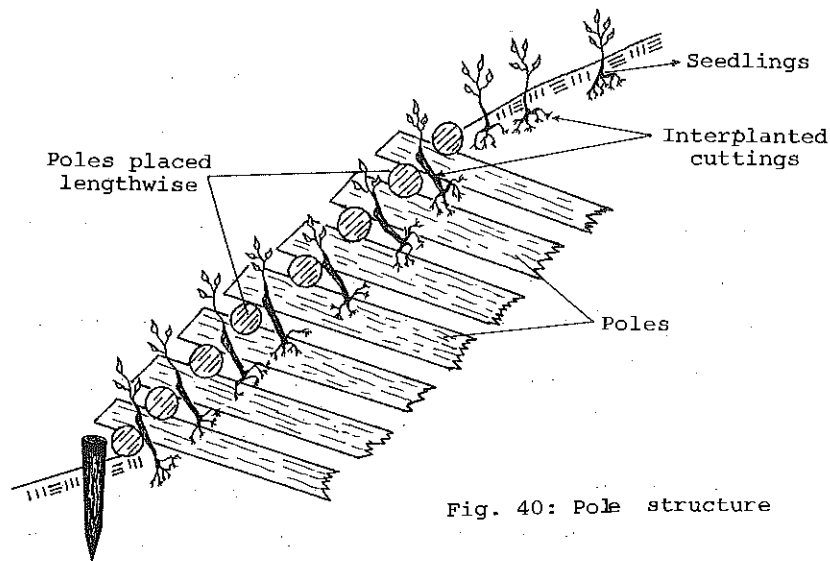

Fig. 40: Pole structure

#### 10.6 Slope stabilization with worn-out tires

For environmental considerations the disposal of worn-out tires is often a problem. Using old tires for slope stabilization may be a good way of disposal, achieving some benefit at the same time without impairing the environment and violating aesthetic values too much. The parts of the tires exposed can be camouflaged by vegetation.

Worn-out tires can be used effectively for retaining walls as shown in fig. 41.

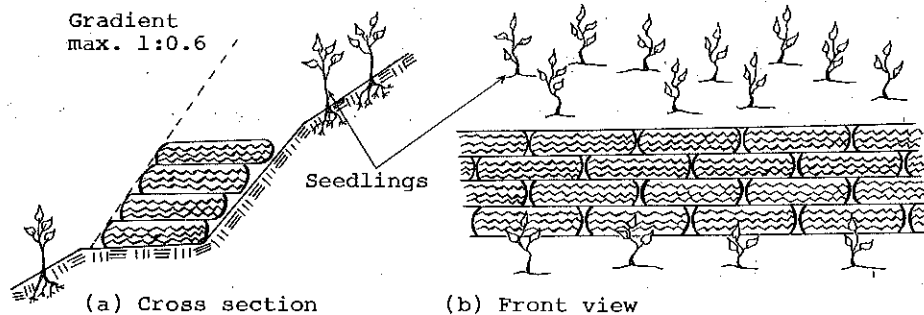

Fig. 41 Retaining wall made of worn-out tires

Lower structures can be made of 2-4 overlapping rows of tires placed in a trench with a depth of half the tire diameter (Fig. 42). Afterwards the trench is refilled with soil and carefully compacted.

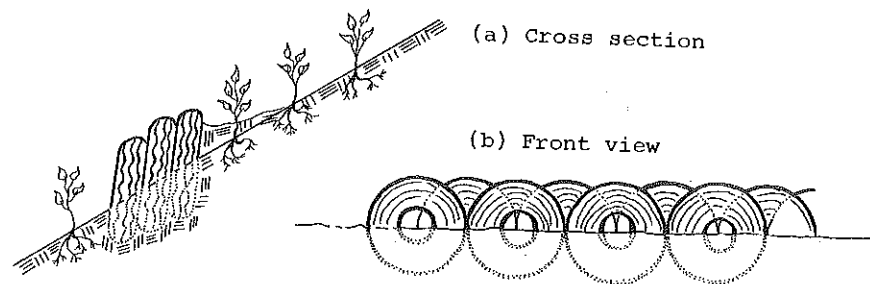

Fig. 42: Low tire structure

Another possibility is to cover the slope with tires parallel to the surface (fig. 43). Seedlings or cuttings are planted inside the tires. A line of tires at the base is built in vertically to prevent the tires from sliding downhill. For additional strength the tires can be connected by wire or fastened by pegs.

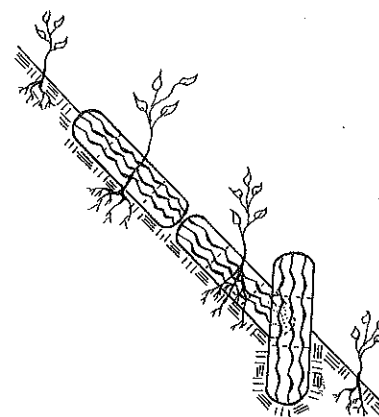

Fig. 43: Tire cover on a slope interplanted with seedlings

GULLY STABILIZATION

Gullies usually originate from concentrations of flowing water on the soil surface. They can start from livestock trails in overgrazed pastures, faulty drainage from roads, neglected rills and furrows in farm lands, logging trails, log landings, clogged drainage canals, etc.

Gully formation is hastened by heavy rainfall, when large quantities of run-off attain a high velocity and increased erosive power. The different shapes of gullies have been discussed in Chapter 1.

In gully erosion control the following phases can be distinguished:

- Improvement of the catchment area of the gully to reduce and regulate the quantity of run-off;
- Stabilization of the gully head to prevent the gully from "eating backward";
- Safe conduct of water through the gully, if it is part of the natural drainage system;
- Reclamation of the gully area, where it is not part of the natural drainage system.

11.1 Improvement of the catchment area

If the cause of gully formation is a denuded watershed with its accelerated run-off, re-establishment of the vegetative cover would be the appropriate measure to take. The area must be planted with shrubs and trees to improve the soil condition, increase infiltration and reduce surface run-off.

In serious cases, the absorbing capacity of the catchment can be increased by "contour bunding" Contour bunding is the construction of low earth dams along the contour, behind which the water can gradually infiltrate into the soil. It is designed more for pastures and agricultural land, but may also be useful for other purposes.

11.2 Stabilization of the gully head

If the gully does not belong to the natural drainage system and stabilization is attempted by planting only, the run-off entering the gully head has to be intercepted by a diversion canal. This canal is dug above the gully head at a distance of once or twice the depth of the gully. It should have a trapezoidal cross-section and must be designed wide enough to conduct maximum rainfall. Precautions must be taken that not a new gully develops from the diversion canal, which should be checked after every typhoon.

Where the gullies are part of the natural drainage system, sometimes only temporary diversion canals are dug. In this case the gully head is stabilized in a way that the gully cannot enlarge by waterfall erosion (see fig. 3) anymore when water enters.

To stop the gully from eating back, the gradient of the gully head is first reduced to about  $45^{\circ}$ . The surface of the gully head is then stabilized by any of the following methods:

- A brush cover well anchored to the ground is the most recommendable vegetative method (see Chapter 9.2).
- Sodding may be possible in grassland, where sods are available. The sods must be "nailed" to the surface.
- Riprap interplanted with cuttings is also a very recommendable method to stabilize a gully head. The lay-out of the riprap should be concave to concentrate the water in the middle. An apron at the bottom is essential to prevent scouring (see fig. 44).



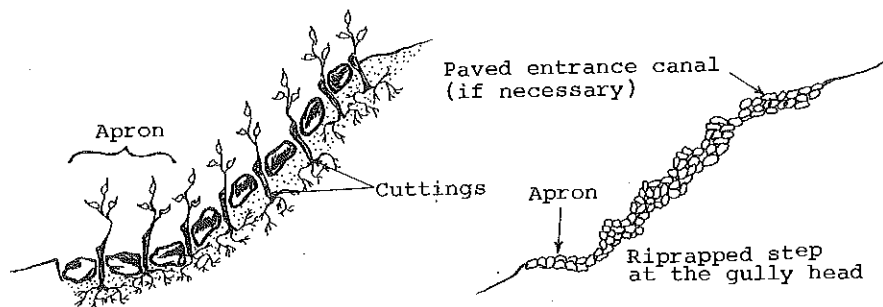

Fig. 44: Stabilization of a gully head by riprap

- Pole structure: In the absence of stones also a pole structure can be employed for the gully head. It should be laid out in V-shape to concentrate the water in the center. An apron must be constructed below and a canal above at the intake (fig. 45).

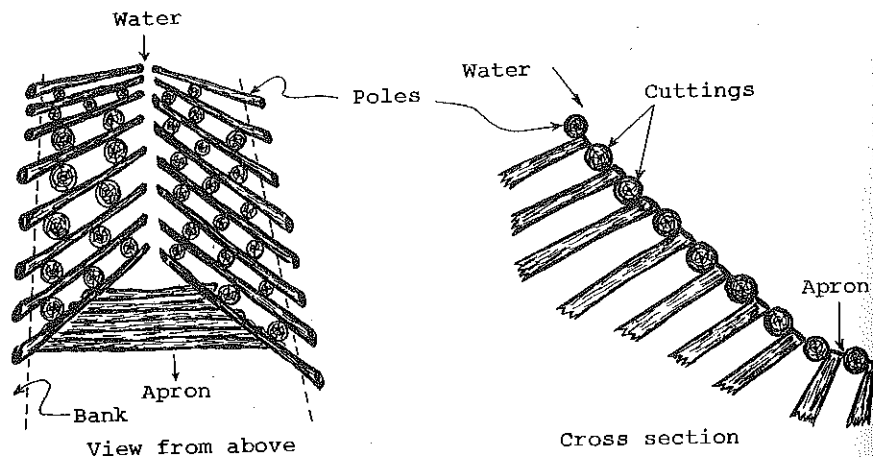

Fig. 45 Gully head stabilization by a pole structure

- Solid structures for gully head stabilization can be made of riprap, gabions, masonry or concrete. The construction can be in the form of an arch as shown in fig. 46. If it is necessary to concentrate the run-off above the gully head, there should be wing walls of earth or riprap. The flow is conducted through a water-spill or notch and falls down to the bottom of the gully bed, which is protected by an apron.

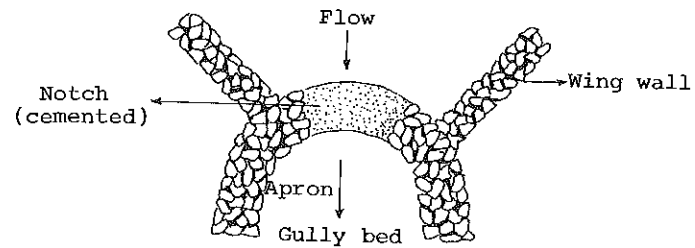

Fig. 46: Gully head stabilization by a solid structure with wing walls (view from above).

### 11.3 Stabilization of gullies belonging to the natural drainage system

After improvement of the catchment and stabilization of the gully head, the gully bed has to be treated to prevent further deepening and widening. This is achieved mainly by various types of checkdams and so-called "ground ties".

The purpose of a checkdam is to reduce the gradient and break the velocity of the flow. Through checkdams the water is conducted safely from a higher to a lower point without causing erosion at the gully bed. The waterpools behind the dams promote the percolation of water into the soil. Checkdams still serve their purpose even when they are completely silted up by reducing the gradient inside the gully.

For gullies which are part of the natural drainage system, only checkdams with a long life-span are suitable. They should be constructed in places where the bed is narrow and the banks are firm. Curves or sites within or just below gully junctions must be avoided.

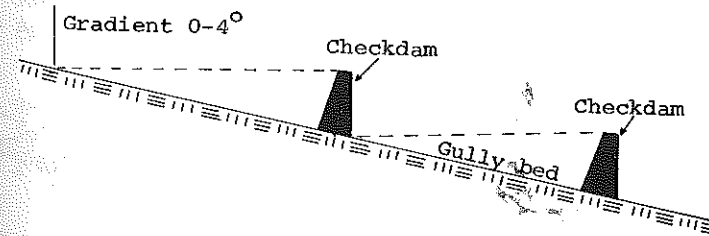

Fig. 47: Spacing of checkdams



In an ideal case, checkdams should be spaced in such a way that the bottom of the upper checkdam is level with the top of the next lower one. In a steep gully this is difficult to achieve because too many checkdams would be required. If the section between two successive checkdams cannot be made level, the gradient should at least not exceed 5 percent.

The height of the dams influences their spacing. There is the alternative of constructing a few high or many low dams on a certain gradient. High checkdams have to resist a greater pressure than low ones and, therefore, are more liable to damages. While concrete or masonry dams can be built at any height, dry stone or brushwood dams should be low. Under normal conditions, the height of a checkdam should not exceed 1 meter.

Checkdams must be well anchored in the ground and particularly in the banks to prevent underscoring and scouring between the dam and the banks. The flow is directed through a water-spill or notch in the center of the dam. Below the dam, where the water hits the gully bed, a protective apron must be constructed. For additional strength the checkdam is filled up to the notch with soil on the up-stream side.

According to the material used the following types of checkdams can be distinguished:

- a) Stone checkdams are most commonly used in gully control and are generally constructed as a dry stone wall. At first the gradient of the gully banks is reduced to about  $45^\circ$  or 1:1. Then a foundation 30 to 50 cm deep extending well into the banks is dug. The soil is piled up-stream to be used later for the re-fill. The largest stones are placed in the bottom layers. The joints in successive layers are broken according to the usual rules of riprap.

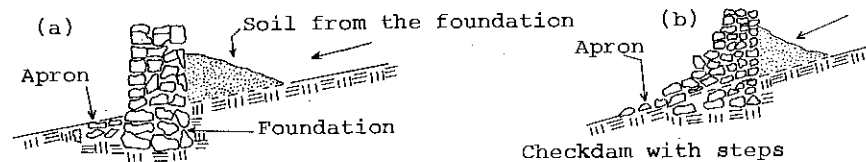

Fig. 48: Dry stone checkdams

Larger checkdams can be constructed with steps in front (fig. 48 b). In every layer of stones a step of 15 to 20 cm is left on the down-stream side, so that the width is reduced from base to top. The advantage is saving of stones and that the flow is gradually conducted down to the apron.

For large dams two wing walls with appropriate foundations are often constructed at the upper side to force the flow into the water-spill or notch and prevent it from damaging the banks. The wing walls should form an angle of about  $30^\circ$  with the banks. For small checkdams wing walls are not required.

In the center of the "crown" a notch of concave shape is to be spared, which must be wide enough to cope with peak run-off. Generally a length of half the span of the dam and a depth of 20 to 30 cm are considered appropriate. For the notch, large flat stones are reserved that cannot be washed away.

When large quantities of run-off are expected, it is advisable to use some concrete for the notch and the crown of the dam, or to cover everything with a wire netting. Below the dam an apron has to be constructed with stones. On the up-stream side the dam has to get an earth fill for greater strength. Finally, the structure is supplemented by planting seedlings and cuttings of suitable species with a dense and wide spread root system like banaba or tibig, or creepers like kudzu or Centrosema along the banks.

- b) Brushwood checkdams are only temporary and are constructed in areas where stones are not available.

At first, a foundation extending well into the banks is dug. The brushwood, sprouting or non-sprouting, is placed between two rows of pegs driven-in 40 cm apart across the gully bed. The distance between the rows should be 0.80 to 1.0 meter for gullies up to 5 meters in width. The brushwood is packed firmly and the two rows of pegs are tied together by wire. On top a notch of about half the span of the dam is spared.

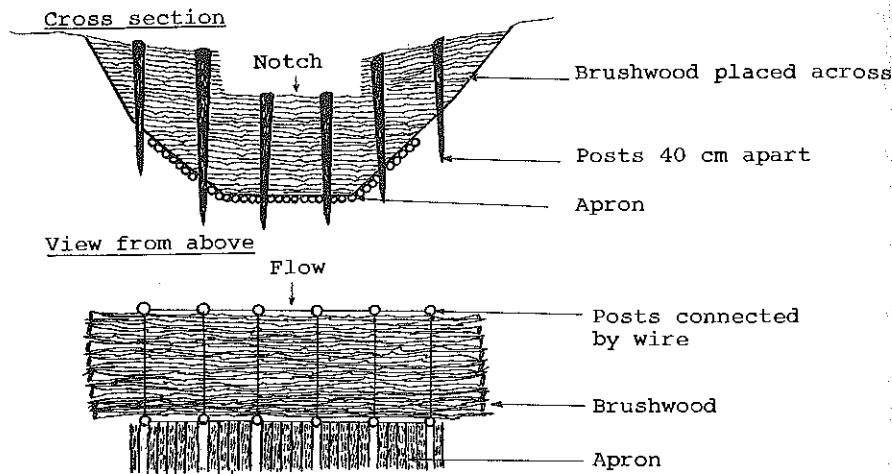

Fig. 49: Brushwood checkdam

On the lower side of the dam, branchwood is placed lengthwise to provide an apron preventing scouring by overflow. It is very important that these temporary structures are supplemented by cuttings and seedlings, which can take over when the brushwood has decayed.

c) Pole checkdams: Where other materials are scarce, checkdams may be constructed of poles or strong branches. Some of the

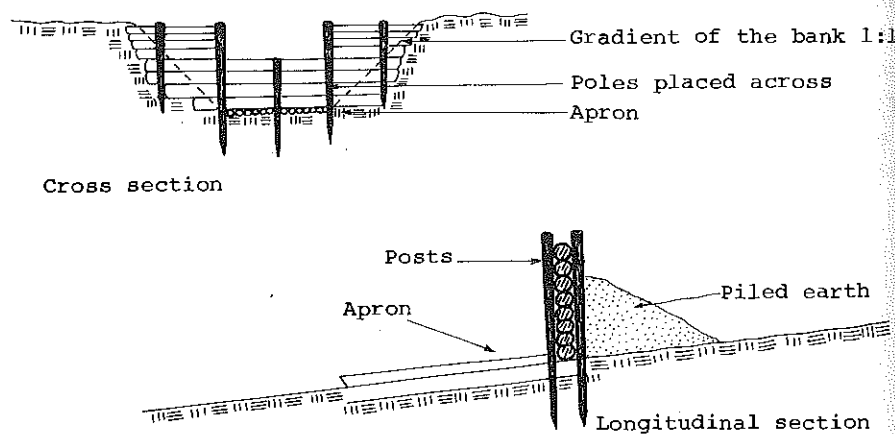

Fig. 50: Pole or log checkdam

poles have to be erected as uprights at intervals of about 60 centimeters to keep the horizontal poles in place. The central posts are taken down to notch level, while the others reach the height of the checkdam. Below the checkdam some poles are placed lengthwise to form the apron.

The horizontal logs are nailed or tied to the uprights by galvanized wire. A structure of this type may last for a few years. It is hoped, that after its decay the vegetation will finally control the expansion of the gully.

- d) Solid checkdams: Where it is justified checkdams can also be constructed of concrete, masonry or gabions. These materials allow much higher structures than the ones described above.
- e) Grating dams: They vaguely resemble pole checkdams, but they have a different function. The objective of grating dams is not to reduce the gradient inside the gully, but only to hold back coarse debris. They are constructed of poles which are nailed horizontally to strong vertical posts. Between the horizontal poles intervals of about 10 cm are left to allow water and finer sediments to pass.
- f) Ground ties: The sections between the checkdams can be stabilized by "ground ties", which consist of cuttings planted between two logs placed across the gully bed. The sprouts will effectively reduce the velocity of the flow.

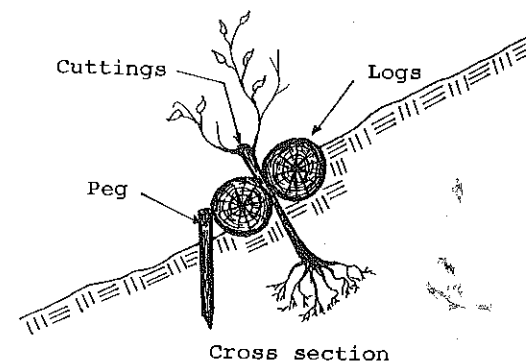

Fig. 51: Ground tie with sprouting brushwood

The logs serve as miniature checkdams, reducing the gradient of the gully bed (Fig. 51). They must be well anchored in the banks. For the cuttings, a bushy species like dumanay should be chosen.

Wherever possible, the gradient of the gully banks must be reduced to about 1:1 and planted with suitable species. If the gully banks are left with a steep gradient, they cannot be colonized naturally by invading vegetation. As the moisture conditions along and inside the gullies are quite favorable, these may be good sites for planting fruit trees and other valuable species.

#### 11.4 Reclamation of gullies not belonging to the natural drainage system

In totally degraded land, gullies can make up for a large part of the area without actually being needed in the natural drainage system. The objective of reclaiming these gullies is to utilize their area again.

If the gullies are not deep, they may be gradually filled up by sediments. Larger gullies have to be stabilized, so that their size will not increase. The general procedure can be described as follows:

- Digging of a diversion canal, if the conditions permit;
- Stabilization of the gully head as described in Chapter 11.1;
- Reducing the gradient of the banks to  $45^\circ$ , so that they can be planted or colonized by a pioneer vegetation. It is also possible to stabilize the banks by cordons and brush covers interplanted with cuttings and seedlings;
- Where necessary, construction of checkdams, which can generally be more of the temporary type;
- Protection of the gully bed and measures to increase siltation.

The methods used here are slightly different from the measures taken for gullies of the natural drainage system, because generally less water can be expected in these non-draining gullies. While the measures described in Chapter 11.3 aim more towards

the reduction of flow velocity by checkdams, here the main purpose is to increase sedimentation to fill up the gully gradually. Checkdams, even permanent ones, may also be constructed where flow is still expected.

Typical measures for the reclamation of non-draining gullies include brush combs and plugging of gullies.

- a) Brush combs: Their function is to reduce the velocity of the flow and "comb out" the sediments, so that the gully is gradually silting up.

In contrast to bench layers the brushwood is placed more vertical. At first trenches, which should follow the contour, are dug 40 to 60 cm deep across the gully bed and the banks. Seen from above the layout will be more or less u-shaped (fig. 52). The brushwood, which must be of a sprouting species, is placed upright and tightly together on the down-stream side of the trench. For greater stability some thin poles are placed horizontally along the butt ends of the brushwood. Afterwards the trench is refilled and tamped.

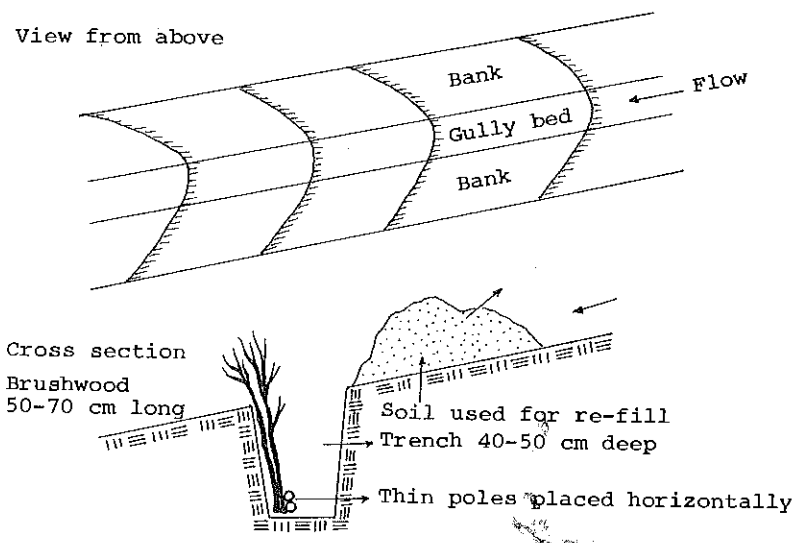

Fig. 52: Construction of "brush combs"

b) Plugging of gullies: Smaller gullies of less than one meter in depth can often be stabilized by plugging them with brushwood. It is laid out lengthwise in the gully, and an anchorage is generally not required, except in steep gullies. The brushwood must be bushy and need not be of a sprouting species. The velocity of the flow will be reduced and the gully gets filled up with sediments.

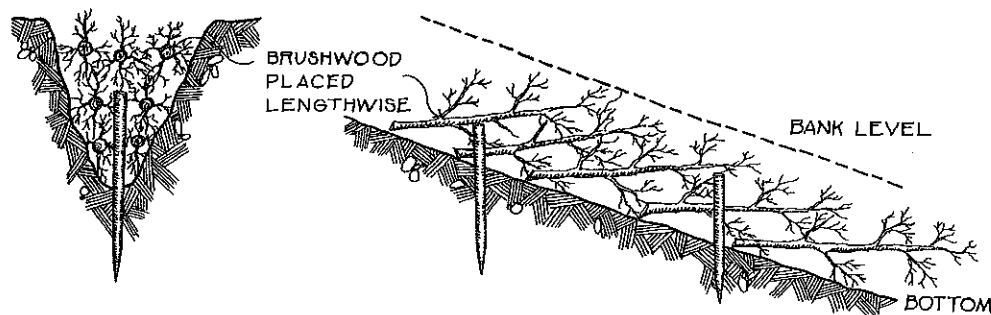

Fig. 53: Plugging of smaller gullies

Riverbanks have special erosion problems as the water level often changes and causes greater parts of the banks to be exposed, which generally are bare of vegetation. The most severe kind of erosion is caused in streams carrying bed-load. Most vulnerable are the outside curves, where the flow is scouring and undercutting the banks. At the inside curves we usually can observe a deposition of sediments.

The methods developed to repair and prevent erosion damages along riverbanks can be divided into four main groups:

- Temporary and emergency measures,
- Methods depending mainly on sprouting brushwood,
- River bank stabilization by planting,
- Solid structures.

Human interference destroying the vegetation along the banks must be stopped. According to the Philippine Forest Law, a strip 50 meters wide has to be preserved on both sides of water courses more than 5 meters wide.

To reduce extreme fluctuation of the water level and heavy sedimentation, it is essential that the catchment area is properly managed. Therefore all kinds of river bank stabilization have to begin with the improvement of the catchment area.

12.1 Temporary and emergency measures

The methods described in this chapter have to be considered only as first aid to stop erosion along riverbanks during floods until more durable and effective measures can be taken.

a) "Rauhbaum" method: Dense and well branched trees or tree tops are placed along the bank with the butt ends pointing upstream and anchored by strong pegs and wire or ropes. The posts to which the trees are tied must be anchored firmly in the riverbed, if necessary with a brace (fig. 55). To protect longer banks several rows of bushy trees have to be placed in a shingle-like formation.

The function of the trees is to reduce the velocity of the flow along the banks. During floods the "Rauhbaum" method may be the only possible measure that can be adopted.

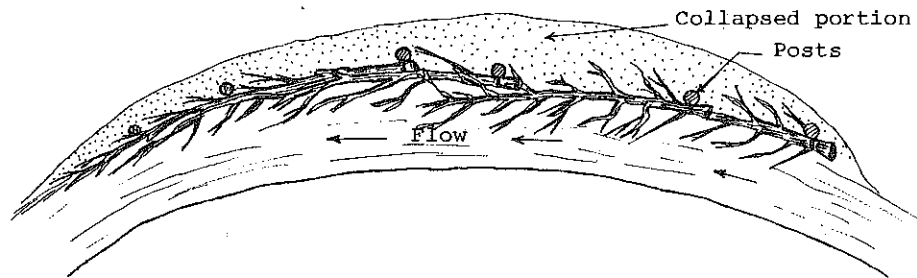

Fig. 54: Temporary protection of a collapsed riverbank by the Rauhbaum method.



Fig. 55: Anchoring of tree in the Rauhbaum method

b) Temporary groynes (German: Rauhbaumbuhnen): This method is used in wide and shallow riverbeds or brooks. With the help of groynes the direction and velocity of the current, and partly the deposition of sediments can be influenced.

Groynes pointing upstream increase sedimentation, those pointing downstream direct the flow to the other bank, those perpendicular to the current serve more for bank protection. As a general rule the distance between groynes should be one to two times their effective length.

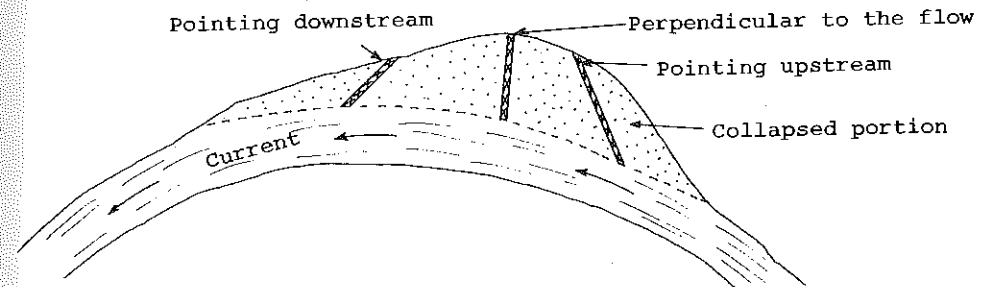

Fig. 56: Layout of groynes

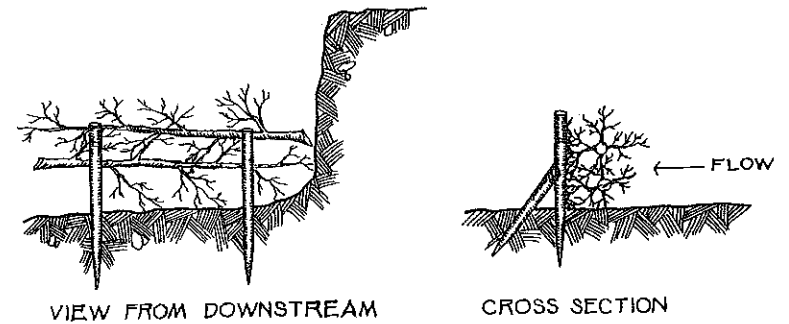

Fig. 57: Construction of temporary groynes

Temporary groynes are installed by driving posts of a diameter not less than 15 cm into the riverbed. Trees or crowns of trees are placed horizontally on the upstream side of the posts and anchored firmly. To resist floods, the posts must be reinforced by supports or braces (fig. 57).

c) Plugging of riverbanks: This technique is recommended for undercut banks. Dense crowns or brushwood is piled up along the eroded portions and held in place by a row of pegs. To avoid that the brushwood is lifted and carried away during floods, the pegs are driven-in in a slanting position (fig.58a). The necessary protection can also be provided by a mesh wire fence, behind which the brushwood is piled up (fig: 58b).

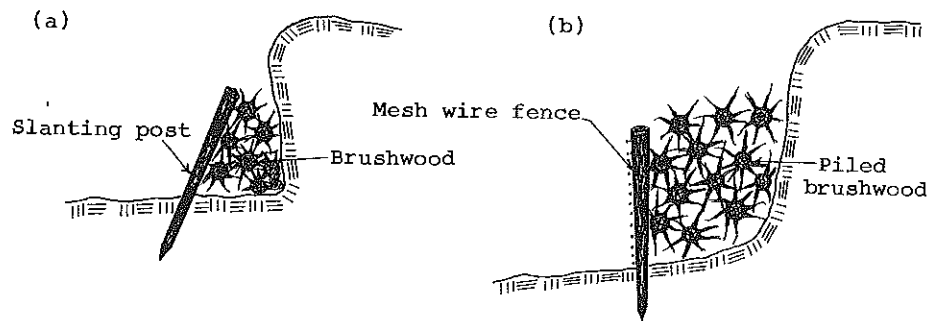

Fig. 58: Plugging of eroded banks

12.2 Methods depending mainly on sprouting brushwood

While in the temporary measure described above any type of brushwood can be used, the following more permanent structures depend mainly on sprouting brushwood, sometimes in combination with other materials.

a) Brushwood groynes (German: Buschbautraversen) made of sprouting brushwood can only be constructed during low water, when the riverbed adjacent to the area to be protected is above the water line and permits soil working. The method is widely employed in Europe and is considered economical and effective.

The effect of a series of groynes is the sedimentation of successively smaller material behind the groynes in the direction of the streamflow due to the reduction of velocity. By a correct placement of the groynes it is also possible to change the direction of the current (see also Chapter 12.1 b).

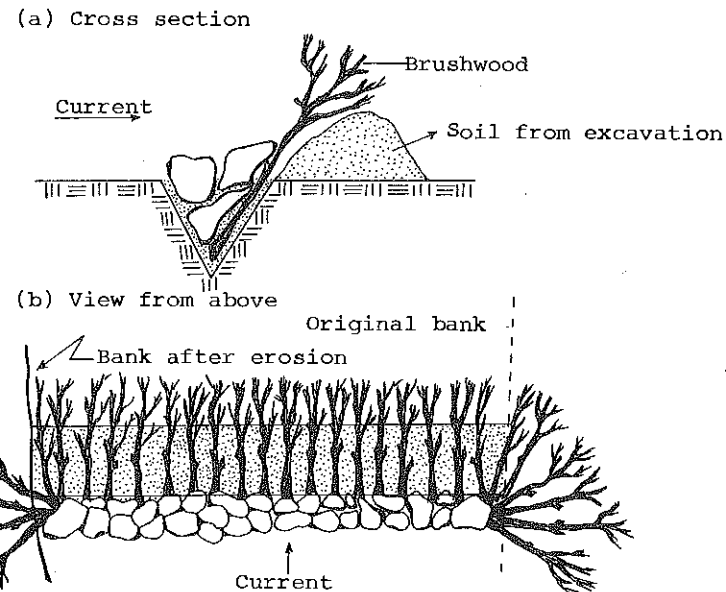

Fig. 59: Construction of groyne with sprouting brushwood

From the damaged bank to the original or desired bank line a trench is dug 30 to 40 cm deep and wide with a triangular cross section. The excavated material is piled downstream beside the trench to give a wider bearing surface to the brushwood. Then brushwood of 1 to 1.5 m length is tightly packed without leaving any holes or weak points. Afterwards the brushes are covered at the butt ends with a thin layer of topsoil, on top of which stones are placed in a riprap pattern, so that the soil is not washed away at high water level. Special protection is needed for the head of the groyne, which is exposed to the current. Brushwood has to be carefully arranged around it and protected by large stones (Fig. 59 b) (according to PRÜCKNER, 1965, modified).

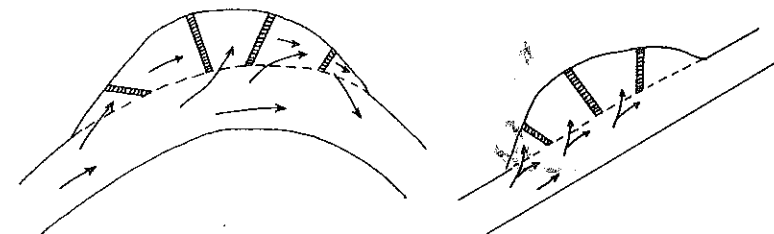

Fig. 60: Arrangement of groynes in a straight river section and in a curve.

A modification uses a mesh wire cylinder of 30 to 40 cm diameter filled with stones or gravel to hold the brushwood in place until it is firmly rooted. Sturdy pegs will prevent that the cylinder is rolled away by strong current. In rivers and streams with a strong current and a heavy bedload longer groyne must be protected by a wooden fence in front of the heads (see fig. 61).

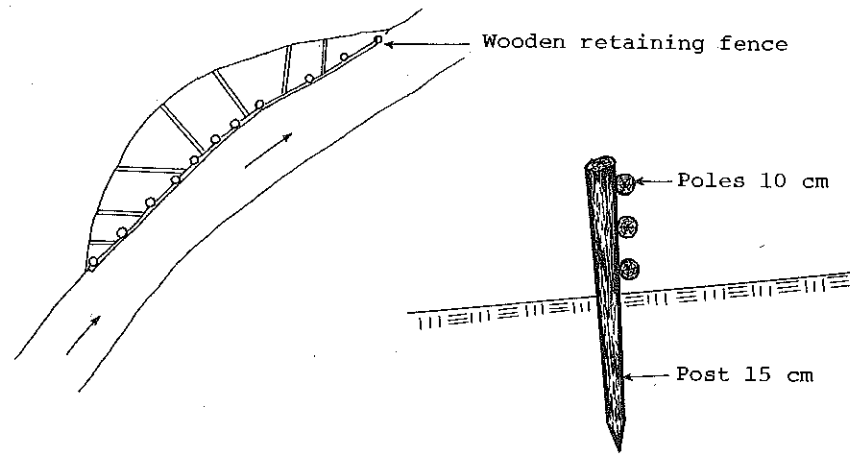

Fig. 61: Protection of groyne by a wooden fence

For groyne all kinds of easily sprouting shrub species can be used, but they must be able to survive prolonged inundation during high water. Riverine species growing naturally within the stream bed or along the banks are most suited. If none are available, also ipil-ipil or madre de cacao may be tried. *Salix tetrasperma*, native from India to Malaysia in medium altitudes, may be worthwhile trying in the Philippines.

If there is only little sedimentation, additional groyne have to be constructed between the old ones. After the spaces between the groyne have been silted up, the area is planted with suitable tree and shrub species.

Brushwood groyne are effective and cheap, since only local material used, but are applicable only in wider streams and rivers.

b) Riprap with cuttings: After the bank has been smoothed and the gradient reduced to  $45^\circ$ , a shallow trench for the foundation is dug at the base of the bank. Riprap is carried out in the usual way, but above the low water line cuttings are planted in the joints. For better growing conditions the joints are filled with topsoil. The height of the pavement should reach at least medium water level, in very vulnerable banks up to high water level. Above the riprap a well anchored brush cover is established.

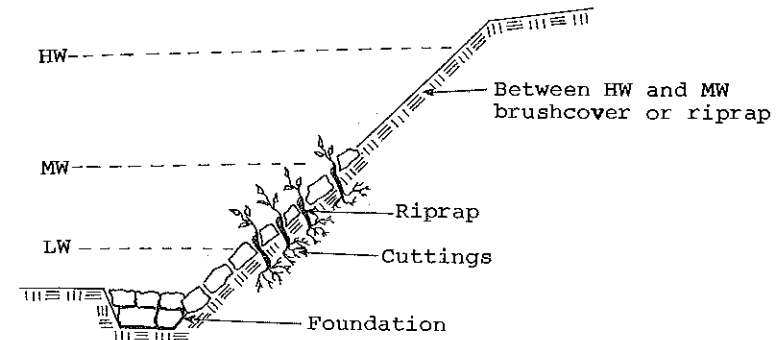

Fig. 62: Streambank stabilization with riprap interplanted with cuttings.

It is also possible to use a mesh wire cylinder filled with stones or gravel as a foundation. The cylinder, which should have a diameter of 30 to 40 centimeters, is placed in a shallow trench at the base of the bank.

In contrast to groyne this method is also applicable in narrow streams and creeks with steep banks. It can resist a high stream velocity dragging along a heavy bed load.

A disadvantage is the high demand for sharp edged stones for the pavement and the higher cost of labor involved.

c) Combined stone and brushwood piling (German: Rauhpäckung): This method is recommended for protecting and repairing the collapsed sections of the outside curves of streams with a high velocity and a high sediment carrying capacity.



Between the damaged bank and the original or desired bank line, stones and strong branches of sprouting species are piled, whereby the brushwood is placed in a more horizontal position. For better strength and anchorage strong posts are driven in first. In the inner part of the pile some topsoil is added to provide better growing condition for the brushwood. The gradient of the piling should not be steeper than  $45^\circ$  and its height reach at least medium water level, where the bank is very vulnerable, high water level.

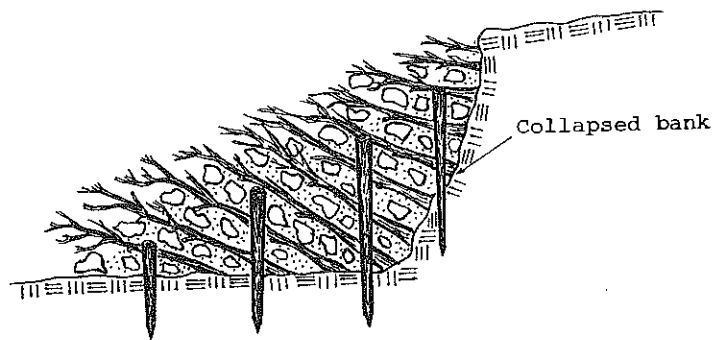

Fig. 63: Combined stone and brushwood piling

In a modification of the above method, which is called "Steinwurf" in German, the brushwood is planted in a more vertical position. The butt ends may be either below the water line or covered with soil. Stones are piled up in between, until only about 50 cm of the brushwood remain exposed. The gradient of the piling must be less than in the original method. The brushwood reduces the stream velocity, so that the spaces between the stones will soon be silted up with sediments.

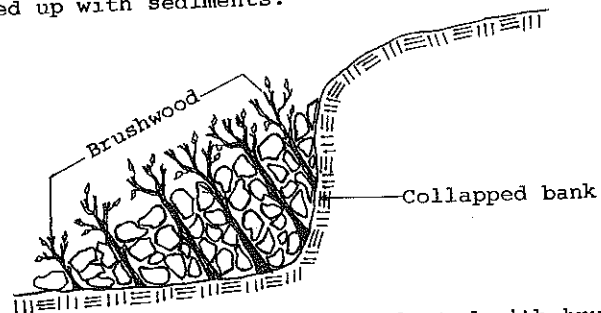

Fig. 64: Stone piling interplanted with brushwood

d) Brush covers (German: Spreitlagen): The basic technique has been described in Chapter 9.2. For river bank stabilization this method can only be applied above the low water line (LW). The lower part of the bank from the river bottom to the low water level needs special protection to prevent undercutting especially along outside curves.

At first the gradient of the slope is reduced to  $45^\circ$ . At the base of the bank a shallow trench 15 cm deep and 25 cm wide is dug (Fig. 65 A), along which dense brushwood is laid out perpendicular to the current with the butt ends pointing towards the slope (B). Then, the brush cover is arranged on the bank with a slight slant downstream in such a way that the butt ends also rest in the trench (C).

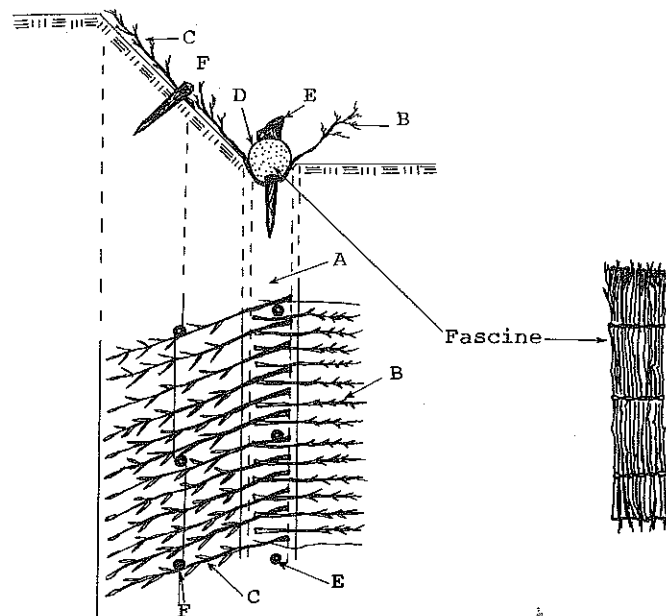

Fig. 65: River bank stabilization with brushcover and fascines (according to PRÜCKNER, 1965)



On top of the butt ends of both layers of brushwood a fascine (D) with a diameter of 20 to 30 cm and a length of at least 3 m is firmly nailed with hooked or straight pegs, which are driven 80 cm deep into the river bed at intervals of 1 meter (E). The stability of the structure depends largely on these pegs. Finally the brushwood on the bank is fastened by wire and pegs (F) and covered partly with soil.

In a similar method several fascines are piled at the base of the bank and no brushwood is used in front.

The base can also be protected by a stone piling (fig. 66), a mesh wire cylinder filled with stones (fig. 67) or a log structure (fig. 68).

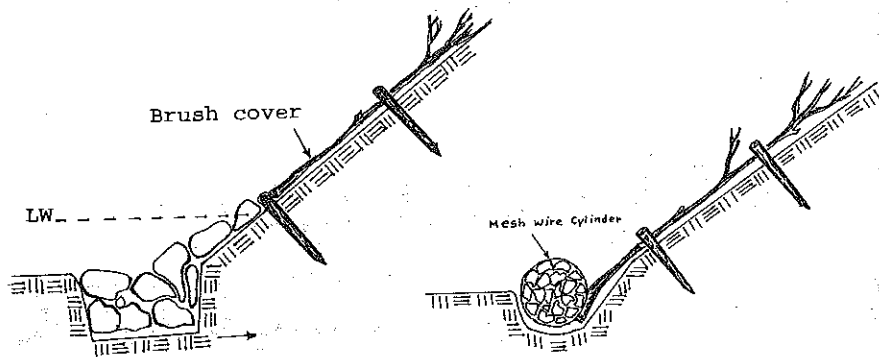

Fig. 66

Fig. 67

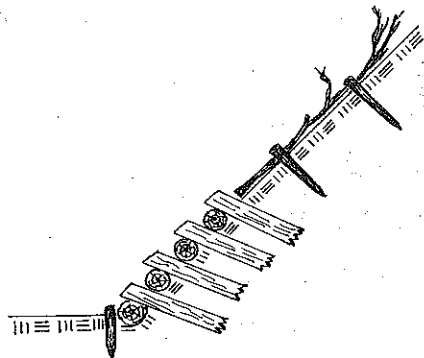
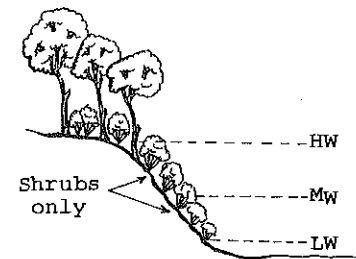

Fig. 68

### 12.3 River bank stabilization by planting

In most cases planting alone is sufficient to stabilize banks of water courses with a more or less permanent water level, slow flowing lowland rivers, irrigation canals, and lakes.

#### (a) Narrow river bed



#### (b) wide river bed

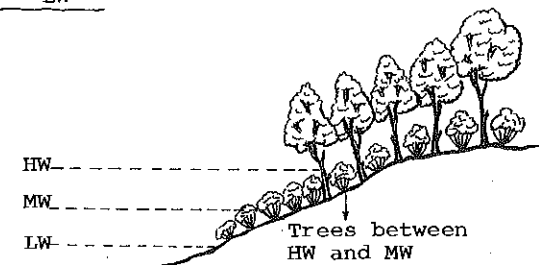

Fig. 69: Planting of trees and shrubs along a river bank

Certain rules have to be followed when river banks are to be stabilized by planting:

- In the zone from low to medium water level usually only shrubs are allowed. The selected species must be able to survive prolonged inundation and must be flexible enough not to break in the current.
- In the adjoining zone from medium to high water level also mainly shrubs are planted, which occasionally are mixed with trees. In narrow stream or river beds, trees, below the high water level would reduce the run-off diameter and so may increase the stream velocity and cause erosion.

- Trees preferably mixed with shrubs are planted above the highest water level.
- The shores of lakes and very slow flowing rivers can also be protected by reeds, and below the water level by aquatic plants, sometimes established within a stone piling.
- Sodding is a good way to stabilize banks where sods are easily available. But usually the supply is a problem and much labor is involved.

#### 12.4 Solid structures

Solid or permanent structures for river bank protection include weirs, permanent groynes, spurs and retaining walls. The design of these structures sometimes requires considerable engineering skills and often the services of a professional engineer. However, their construction may occasionally become the work of foresters, who have specialized in watershed management.

- a) **Weirs:** Their main purpose is to break the stream velocity and to conduct the water safely from a higher to a lower level. By weirs the current can be forced into the desired course because the water has the tendency to pass the weir in perpendicular direction (fig. 70). In the ideal case the weirs should be spaced in a way that the water level of the lower weir is level with the bottom of the upper one.

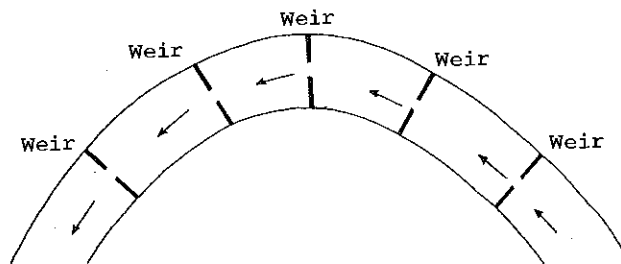

Fig. 70: Breaking the direction of the flow by weirs

Weirs can be constructed with concrete, masonry or gabions. The foundation in the river bed and the embankment must be deep enough to prevent underwashing and scouring. The dimensions depend on the run-off quantity, its fluctuations and the shape of the river bed. The waterspill can be rectangular or concave.

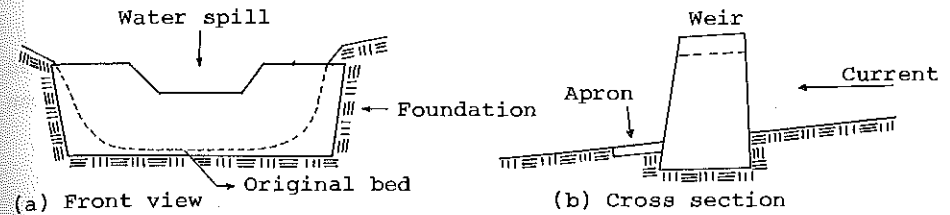
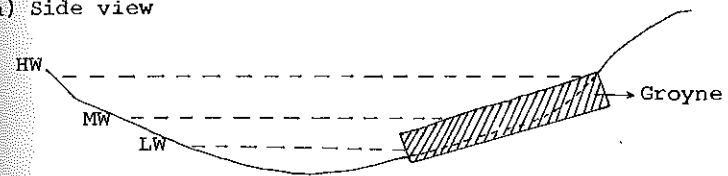

Fig. 71: Construction of weirs

- b) **Solid groynes** can be constructed with concrete, masonry, gabions or in riprap. Sometimes also so-called "rock sausages" are used, which are galvanized mesh wire cylinders filled with stones and anchored firmly in the ground by strong posts.

Groynes are placed on the slope of the bank. Their upper end should be higher than the medium water level. At low water level only the head of the groyne will be under water (fig.72). For the arrangement of groynes see fig. 56, 60 and 61.

- (a) Side view



- (b) Cross section

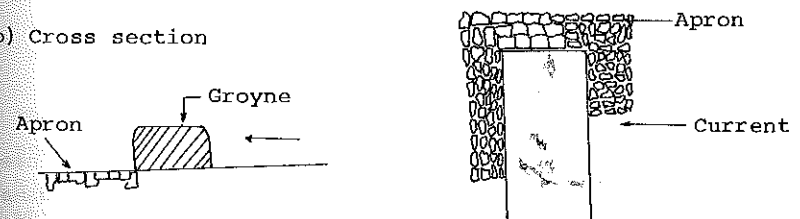

- (c) Head of groyne (from above)

Fig. 72: Construction of a solid groyne

Downstream below the groynes an apron must be placed to avoid underwashing. The head of the groyne needs special protection and has to be surrounded by an apron.

- c) Spurs are very similar to groynes. However, they are shorter and generally point downstream or perpendicular to the current. Like groynes they can be constructed with concrete, masonry, or riprap reinforced by a wooden frame.
- d) Retaining walls: Their construction has already been described in Chapter 10. For river bed stabilization retaining walls can be made of gabions, mesh wire cylinders filled with stones, concrete or masonry. A dry stone wall (riprap) can only be considered as a revetment. Retaining walls must reach the high water level.
- e) Ground ties can serve as miniature weirs to prevent erosion in smaller stream beds.

Poles or logs of durable species are placed across the river bed after it has been levelled. Both ends must penetrate into the banks at both sides. The log is held in place by a row of pegs, which also should prevent underwashing. Instead of a pole or log, also a "rock sausage" can be taken.

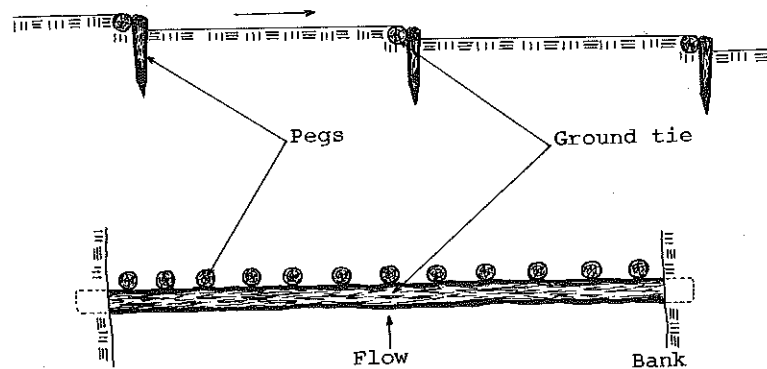

Fig. 73: Construction of a ground tie

Like a plantation all kinds of river bank stabilizations need some maintenance after their establishment. All smaller damages must be repaired immediately before getting worse. Obstacles in a narrow bed must be removed before they will cause damage.

Shelterbelts are strips of vegetation consisting of a mixture of trees, shrubs and vines with the aim to protect valuable cropland from destructive winds. Besides this, they have other benefits, which compensate for the loss in productive area:

- Shelterbelts reduce the wind velocity on both sides. The effect can be felt 15 times the height of the belt in the lee and about 5 times the height of the belt on the windward side. A reduction of wind velocity would minimize wind erosion on light soils.
- On hills shelterbelts with their dense vegetation act as buffer strips intercepting surface run-off and reducing water erosion.
- Shelterbelts laid out or preserved along creeks or streams can also serve as a bank protection.
- Shelterbelts may improve the micro-climate by reducing evaporation and provide good growing conditions to crops which require a calm atmosphere.
- For shelterbelts one can use trees and shrubs yielding minor forest products or even fruit trees.
- Shelterbelts improve the appearance of a landscape, especially if a few bright flowering ornamentals are added to the mixture.

Shelterbelts must be dense in their lower part, whereas the middle and upper parts should be more open. A completely impermeable wind barrier is aerodynamically unsound, because it would cause whirlwinds in the lee and eliminate the protective effects. The upper part should allow the wind to pass, reducing its velocity by only "combing the wind".

(a) Dense shelterbelts

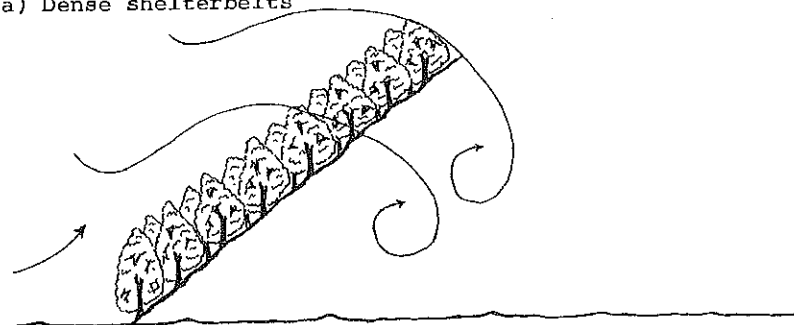

(b) Shelterbelt, irregular and open in upper part

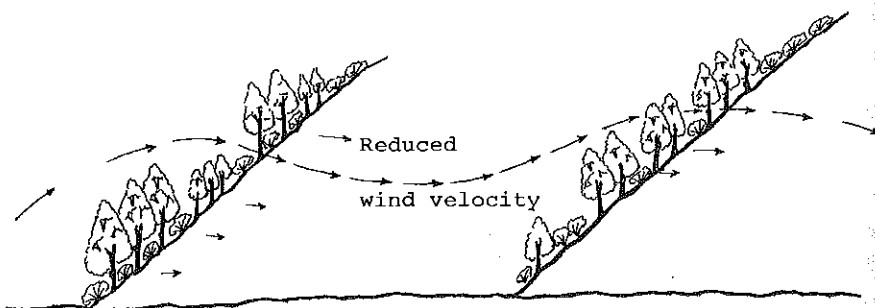

Fig. 74: Wind behavior in dense (a) and open (b) shelterbelts.

A shelterbelt should consist of approximately 65% shrubs and 35% trees, which are further subdivided into about 15% tall and 20% medium sized trees. The seedlings are planted in groups of 2-7 plants of the same species. Large trees are planted in small clusters, small trees and shrubs in larger groups. The following species are suggested for shelterbelts:

- Tall trees: agoho, narra, teak, Gmelina arborea, molave, antipolo, kaimito, santol, sampaloc.
- Medium trees: kamachile, casoi, mabolo, banaba, ipil-ipil, madre de cacao, Cassia spp., akleng-parang.
- Shrubs, and bamboos: lantana, sunflower, aroma, boho, kawayan, kawayan-kiling.

There are many other suitable species. They must be wind resistant and should not have very heavy crowns.

Shelterbelts consist of 1 to 5 rows. Broader belts are preferred for the main skeleton system across the main wind direction at a distance of 300-400 meters. Smaller belts, consisting 1-3 rows, can be planted in between, either parallel or perpendicular to the main belts.

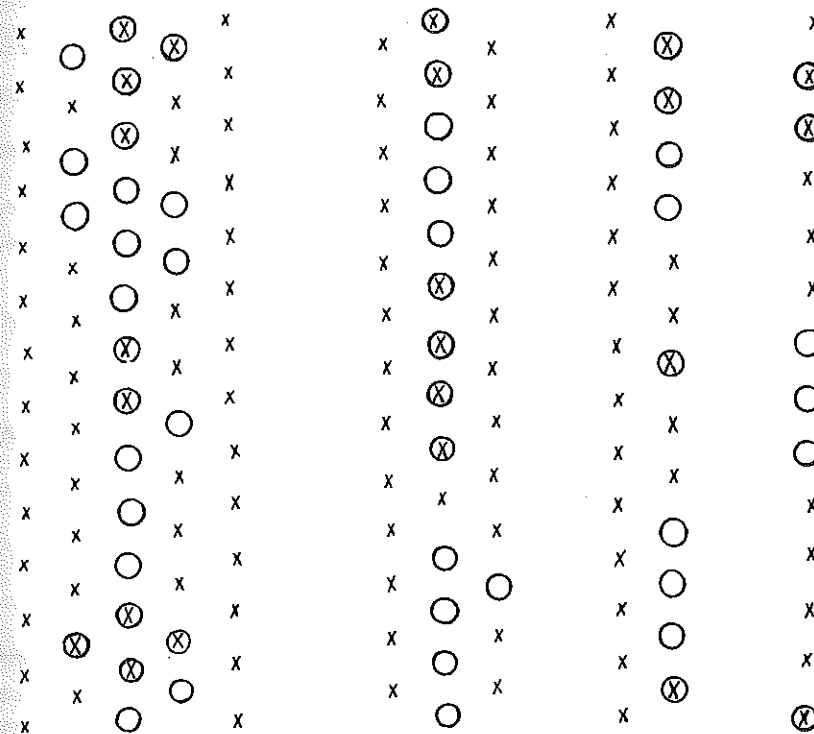
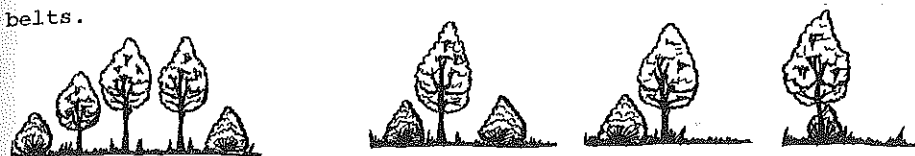

⊗ Tall tree      ○ Medium sized tree      X Shrub, vine

Fig. 75: Planting schemes for shelterbelts with 5, 3, 2 and 1 row (from left to right)

On sloping land, where shelterbelts also act as buffer strips to reduce erosion, the main belts should follow more or less the contour lines. The distance between the belts should be less than on flat land. Secondary belts should preferably be established on non-agricultural land along water ways or traffic lines to minimize the loss of productive area.

EXPRESSION OF GRADIENT

Appendix I

| Percent | Degrees | Degrees | Percent |
|---------|---------|---------|---------|
| 1       | 0°34'   | 1       | 1.8     |
| 2       | 1°9'    | 2       | 3.5     |
| 3       | 1°43'   | 3       | 5.2     |
| 4       | 2°18'   | 4       | 7.0     |
| 5       | 2°52'   | 5       | 8.8     |
| 6       | 3°26'   | 6       | 10.5    |
| 7       | 4°0'    | 7       | 12.3    |
| 8       | 4°34'   | 8       | 14.1    |
| 9       | 5°9'    | 9       | 15.8    |
| 10      | 5°43'   | 10      | 17.6    |
| 11      | 6°17'   | 11      | 19.4    |
| 12      | 6°51'   | 12      | 21.3    |
| 13      | 7°24'   | 13      | 23.1    |
| 14      | 7°58'   | 14      | 24.9    |
| 15      | 8°32'   | 15      | 26.8    |
| 16      | 9°5'    | 16      | 28.7    |
| 17      | 9°39'   | 17      | 30.6    |
| 18      | 10°12'  | 18      | 32.5    |
| 19      | 10°45'  | 19      | 34.4    |
| 20      | 11°19'  | 20      | 36.4    |
| 25      | 14°2'   | 21      | 38.4    |
| 30      | 16°42'  | 22      | 40.4    |
| 35      | 19°45'  | 23      | 42.5    |
| 40      | 21°48'  | 24      | 44.5    |
| 45      | 24°14'  | 25      | 46.6    |
| 50      | 26°34'  | 26      | 48.8    |
| 55      | 28°49'  | 27      | 51.0    |
| 60      | 30°38'  | 28      | 53.2    |
| 65      | 33°1'   | 29      | 55.4    |
| 70      | 35°0'   | 30      | 57.7    |
| 75      | 36°52'  | 31      | 60.1    |
| 80      | 38°40'  | 32      | 62.5    |
| 85      | 40°22'  | 33      | 64.9    |
| 90      | 42°0'   | 34      | 67.5    |
| 95      | 43°32'  | 35      | 70.0    |
| 100     | 45°0'   | 36      | 72.7    |
|         |         | 37      | 75.4    |
|         |         | 38      | 78.1    |
|         |         | 39      | 81.0    |
|         |         | 40      | 83.9    |
|         |         | 41      | 86.9    |
|         |         | 42      | 90.0    |
|         |         | 43      | 93.3    |
|         |         | 44      | 96.6    |
|         |         | 45      | 100.0   |

Ratio (tan) Degrees (rounded)

|        |    |
|--------|----|
| 1:0.25 | 76 |
| 1:0.5  | 63 |
| 1:1    | 45 |
| 1:1.5  | 34 |
| 1:2    | 27 |
| 1:2.5  | 22 |
| 1:3    | 18 |
| 1:3.5  | 16 |
| 1:4    | 14 |

Note: The first figure refers to the height, the second to the horizontal distance:

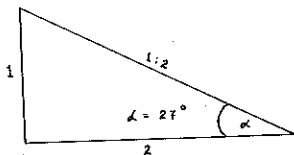

REFERENCES

- BEGEMANN, W., 1971 Umweltschutz durch Gewässerpflege. DRW-Verlagsgesellschaft, Stuttgart
- BENNET, H.H., 1955, Elements of soil conservation. 2nd. Ed. McGraw-Hill Book Co., New York
- BERRY, M.J., 1956, Erosion control in Bukit Bakar Kelantan. Malay Forester 19(1)
- BRADY-BIRKS, S.G., Good soil. The English University Press, London
- CREMER, H.D. and VON BLANKENBURG, P., 1971, Handbuch der Landwirtschaft und Ernährung in den Entwicklungsländern. Vol. 2, Verlag Eugen Ulmer, Stuttgart
- DIMPFLMEIER, R. and SCHWEIGER, H., 1970, Böschungsbegrünung mit Gras- und Gehölzsamen. Allgemeine Forstzeitschrift (25)25
- F.A.O., 1959, Tree planting practices in temperate Asia. F.A.O. Forestry Development Paper No. 14, Rome
- F.A.O., 1962, Forest influences. F.A.O. Forestry and Forest Products Studies No. 15, Rome
- F.A.O., 1963, Tree planting practices for arid zones. F.A.O. Forestry Development Paper No. 16, Rome
- F.A.O./U.N.D.P., 1971, The Philippines. Technical Reports No. 6, 7 & 9, Rome
- FRIEMER, W., Grün ist Trumpf, Handbuch für die Erhaltung einer gesunden Landschaft. Eigenverlag
- HENTZE, J. and TIMM, J., Wasserbau. - B.G. Teubner, Stuttgart
- HUBER, R., 1967, Das Wasser. Verlag Hallwag, Bern
- JAPANESE FORESTRY AGENCY, Soil conservation in Japan. Tokyo
- KIRWALD, E., 1958, Heilung von Bodenwunden. Eugen Ulmer, Stuttgart
- KIRWALD, E., 1964, Gewässerpflege, München
- KLAUSING, O., 1972, Vegetationsbau an Gewässern. Hessische Landesanstalt für Umwelt, Wiesbaden

- KOHNKE, H., 1966, Soil science simplified.  
Balt Publishers, Lafayette, Indiana
- KOHNKE, H. and BERTRAND, A.R., 1959, Soil conservation.  
McGraw-Hill Book Co., New York
- KRONFELLNER-KRAUS, G., 1970, Über offene Wildbachsperrren.  
Mitt. d. Forstl. Bundes-Versuchsanstalt, Wien
- PRESIDENTIAL COMMITTEE ON WOOD INDUSTRIES DEVELOPMENT (PCWID), 1971,  
Philippine forestry and wood industries development. Manila
- PRÜCKNER, R., 1965, Die Technik des Lebendverbaus.  
Osterreichischer Agrarverlag, Wien
- REICHSLEITUNG DES ARBEITSDIENSTES, 1934, Handbuch der Arbeitstech-  
nik. Reichskuratorium für Wirtschaftlichkeit, Leipzig
- SAMAKA SERVICE, 1962, The Samaka guide to home site farming.  
Samaka Service Center, Manila
- SCHIECHTL, H.M., 1958, Grundlagen der Grünverbauung.
- SCHMALZ, 1969, Die Bedeutung des Waldes für den Wasserkreislauf.  
Forstarchiv (40) 7/8, Hannover
- STALLINGS, H.H., 1957, Soil conservation. Prentice-Hall, Inc.,  
Englewood Cliffs, N.J.
- STRELE, G., 1950, Grundriss der Wildbach- und Lawinenverbauung.  
Springer Verlag, Wien
- TSE-CHEN SHENG and HAN KANG, Windbreaks in Taiwan.  
Chinese-American Joint Commission on Rural Reconstruction,  
Taipch
- WEBER, 1971, Der Forstbetriebsdienst. BLV, München
- WEIDELT, H.-J., 1971, Methods of slope stabilization by vegetation.  
Reforestation Monthly 10(17/18), Manila

PART VI

F O R E S T T R E E S E E D S

G. SEEBER and A. AGPAOA

Chapter 1:

SOURCES OF FOREST TREE SEED.

1.1 Introduction

Tree seed may be obtained from private seed collectors, from the Central Seed Store, from neighboring reforestation projects, or from own collection within the project area.

The collector is paid for the quantity of seed he has gathered according to the price per unit that was agreed upon. Before the collection starts, the Forester-in-Charge and the collector sign a contract regarding the price per unit, the quality of the collected seed, the stands and mother trees where the seed is to be gathered, and other specific conditions set by the Forester-in-Charge.

To find a just unit price the forester must know the quantity of seed a man is able to collect per day. This may vary with the intensity of seed production, distances between mother trees, topography, etc.. Generally it is cheaper to buy seed from a private contractor than to collect it with project personnel.

Private collectors must be supervised that they collect the seed from the indicated stands and superior mother trees only, and observe all the other conditions of the contract. There is a tendency, that the seed will be collected from stunted trees with low spreading branches, because they are easier to climb. But stunted, branchy trees usually have undesirable genetical qualities, so that no seeds should be obtained from them.

In most cases, however, the forester has to look for a suitable seed source within his reforestation project or the



vicinity. This would have the following advantages (8):

- Seed collection can be properly supervised;
- If the seed is collected from a superior stand, one can also expect a similar performance on a nearby planting site;
- Only mature seeds are collected;
- Proper treatment of seeds after collection can be assured;
- The storage of seed can be better controlled.

If the quantity bought from private collectors and gathered by own project personnel is not sufficient, a request for additional seeds must be made to the Central Seed Store well in time.

### 1.2 Seed Certification

The objective of seed certification is to make forest tree seed of good quality (pure, viable, genetically superior), true to variety, and with records of origin available to forestry.

The International Seed Testing Association and the International Crop Improvement Association have recommended minimum standards for certified seed, not only for forest tree seed, but also for many agricultural crops (12,19,20). In some countries, as in Germany and Great Britain, these standards are fixed by law and controlled by government agencies. According to these standards forest tree seed can be graded into the following classes (20):

| Grade          | Specifications                                                                                                     | Preference rating |
|----------------|--------------------------------------------------------------------------------------------------------------------|-------------------|
| Certified Seed | from genetically superior trees                                                                                    | 1                 |
|                | a) proven by progeny tests in zones where trees will be planted;                                                   |                   |
|                | b) proven by progeny tests outside planting zone, but in a locality with similar climatic and geographic features; | 2                 |

- classes of tree seed - continued -

| Grade                       | Specifications                                                                                                                                  | Preference rating |
|-----------------------------|-------------------------------------------------------------------------------------------------------------------------------------------------|-------------------|
| Selected Tree Seed          | Not progeny tested, but seed was collected from rigidly selected trees or stands from localities with similar climatic and geographic features; | 3                 |
| Source-identified Seed      | Not progeny tested, but from natural stands and successful plantations of known geographic origin;                                              | 4                 |
| Seed of Questionable Origin | Neither source certified nor selected.                                                                                                          | 5                 |

Up to now no classification for Philippine forest tree seed is in use and consequently no certified forest tree seed is available. Seed obtained from the Central Seed Store will be accompanied by a certificate indicating only the germination capacity and the number of seedling that can be expected to be raised from 1 liter of seed (Seed Issue Certificate) (33).

As a first step towards seed certification seed should be accompanied by the following information written inside and outside the packages or containers:

- Species: local name and scientific name;
- Date of collection;
- Place of collection: reforestation project, sitio, barrio, municipality, province;
- Altitude and climatic region;
- Mother tree or seed collection area;
- Treatments, if any: refrigerator storage, dusting with insecticides;
- Purity percent, if known;
- Germinative capacity, if known.



### 1.3 Seed Origin

#### a) Geographical variations

The importance of seed origin in collecting tree seed was recognized initially by European foresters during the 19th century. Most European countries and the USA now have enacted laws regulating the distribution of forest tree seed. It is specified by law, that the origin of seeds must be shown on all seed lots marketed.

Seed origin is important, because differences often exist between individuals of a species growing in separate areas of the natural habitat. In any one environment the individuals of a species are subject to natural selection, that eliminates unfit plants and results in the preservation of those adapted to that particular environment. Therefore, members of a particular species growing in one locality may differ markedly in some of their hereditary characteristics from members of the same species growing elsewhere (12). There can be geographical variations regarding the rate of growth, form of the trunk, branching habit, resistance to cold, drought, insect attack and fungus diseases.

The selective influence of the environment applies especially to species with a wide natural habitat such as some Eucalyptus and pine species or teak.

Teak is a very typical example of a tropical tree species with a wide natural habitat resulting in many distinct geographical races or provenances (19). The different races of teak can be distinguished by botanical characteristics such as size and color of leaves, color and structure of the bark, straightness of the trunk. The teak races of Northern Thailand and Northern Burma are known for their straight boles. Teak from India is generally more branchy, although the teak from Nilambur, South India has excellent straight and round trunks. In the Philippines, teak planted in most reforestation projects is rather branchy and stunted. The introduction of new races from Thailand or South India might improve this situation.

The different provenances also vary in their ecological requirements. Teak of Northeast Thailand can grow on almost pure calcareous soil. It has a fine grained wood and is highly prized in the timber trade. Teak of Northwest Thailand (Chiangmai) tolerates compact and heavy soil. Provenances from Northern Thailand and Northern Burma have fairly high moisture requirements, while teak from India tolerates longer and more severe dry seasons.

For a successful reforestation work therefore the origin of seed has to be taken into account. Failures, as well as poor yields, may occur, if seed is used from trees growing in an environment entirely different from the reforestation area. Preference should be given to seeds from regions with climate and soil conditions similar to those of the planting site. For that reason, the so-called seed collection zones have been established in some European countries and in the USA to ensure, that only suitable seed is used.

#### b) Individual Variations - Selection of Mother Trees (20)

Besides the geographical variations, there are also individual variations between the trees growing within a particular geographical range or even within a stand. These variations are also largely of genetic nature, that means they are hereditary. The appearance of a mother tree is a good indication for the expected quality of its offspring. Chances are good, that seedlings being raised from seed of forked or crooked seed trees will also be forked or crooked, although the outer (phenotypical) appearance can be influenced by the environment. For instance, a tree of poor shape growing on a difficult site may have good genetic properties. Unless trial plantings, or better, progeny tests are conducted, we do not know exactly, what the genetic qualities of a mother tree are. However, seed from a mother tree of excellent form and growth (plus tree) will most likely yield a higher percentage of trees with favorable form and growth rate than seed from a tree of poor characteristics.

Visible important traits of mother trees to be selected for seed collection are stem form, branching habits, growth rate and resistance against diseases and adverse climatic conditions.

#### Stem form:

- Apical dominance is the tendency of trees to maintain a single dominant stem throughout the crown. Conifers should maintain a straight single stem for more than 80% of their total height, for broadleaved species 60% is acceptable.
- Straightness of the stem is one of the easiest characteristics to evaluate, but, nevertheless, one of the most important.
- Roundness is desirable especially for veneer logs, but also to a certain degree for sawn timber and pulpwood. Elliptical logs are likely to contain a high proportion of undesirable tension and compression wood. Fluted stems have a high percentage of waste in the saw mill. A way to determine the roundness of a stem is to measure the largest and the smallest d.b.h. with a caliper.

#### Branching:

- Diameter of branches;
- Number of branches;
- Angle between branch and stem: Branches, which form a small angle with the stem are likely to cause timber defects later. Preferred are trees with more or less horizontal branching.
- Tendency towards epicormic branching becomes more apparent in open stands.

#### Growth Rate:

- Height and diameter are the best criteria to compare growth rates. In even-aged stands it is easy to rate growth on the basis of the crown position. Dominants should rate "high", codominants "acceptable", and intermediates "low".

#### Resistance against diseases and adverse climatic conditions

can be to a certain degree hereditary. If for example all trees but one in a stand are affected by a particular disease, there is a chance, that this tree was spared because of some genetical quality, which may be also present in part of the offspring.

#### c) The genetical value of seeds from different sources

The value of any seed source is best determined by a progeny test, i.e. by judging the performance of the young plantations raised from its seed. This takes considerable time, but gives a clear indication which seed source would provide the relatively best trees (12). Natural stands generally yield pure seed of the local provenance, while in plantations there can be cross-pollination from outside sources. The quality of seed gathered from plantations, where all poorly shaped individuals have been removed in early thinning operations, is expected to be higher than if such thinnings are not carried out.

Seed gathered only from selected mother trees or plus trees may be expensive, but will result in better plantations having characteristics similar to the parent trees. Even in the offspring of plus trees, however, there can be individuals with poor genetical characteristics, because of cross-pollination with pollen coming from undesirable parent trees. If the mother trees, however, are of excellent quality, the number of poor individuals in the offspring is generally quite small.

One further measure to improve the genetical quality of forest seed and to eliminate the contamination from outside sources is the establishment of seed orchards. Mature scions of plus-trees are grafted on vigorous seedlings that will flower and bear fruit already a few years after grafting. To avoid self-pollination, which results in poor seed quality, scions of at least 12 to 15 plus-trees are selected. All trees obtained by vegetative propagation from one plus-tree have the same genetical characteristics as the mother tree

and are called "clones". In selecting a suitable area for the establishment of a seed orchard, it is important that the species to be propagated does not occur in its vicinity, to avoid contamination from the outside. The different clones are planted intimately mixed at a wide spacing. The trees are not allowed to grow tall, so that seed can be easily harvested from them.

## Chapter 2:

### SEED COLLECTION

#### 2.1 Timing of Seed Collection

Seeds or fruits should be collected, when they are mature. Immature seed has a low germination capacity and may not keep well in periods of storage. On the other side the seed or fruits must be harvested before they deteriorate.

The best time for harvest is immediately after the seed became mature, especially when it is wind disseminated or eaten by birds and rodents. The time the seeds are scattered after maturity varies with the species. The wind-disseminated pine seeds, for instance, remain in the cones quite long before they will be released.

Usually it is better to harvest, before the fruits become excessively dry. Collecting during the early morning hours with high humidity will minimize scattering of seeds. The fruits of Kaatoan bangkal (*Anthocephalus chinensis*) are eaten by ants, they should therefore be collected immediately after falling.

The first fruits falling are often wormy, abortive or otherwise inferior. It has been observed, that the first fruits of Dipterocarp species that fall upon ripening are usually defective. Collecting should therefore be delayed, until the greater portion of the fruit has fallen (8).

Species, that retain their unopened fruit on the tree for some time after maturity like Benguet pine and Mindoro pine, can be harvested at any time before the seeds are disseminated.

Uneven ripening is another problem with some species. Some seeds become completely mature and drop, while others on the same tree are only partly developed. Mindoro pine (*Pinus merkusii*) is such a case. The ripening period of Mindoro pine cones is very protracted, lasting from January to July in Zambales. At any one time during this period the current crop of cones on one tree will display all stages of ripeness. The result might be inevitably, that some green or immature cones are harvested (34).

It is important to have an idea about the approximate time the seed ripens to be able to make the necessary preparations and have the tools in order. The exact time of ripening varies a little from year to year and from locality to locality for the same species. At southern extremes of a species' range or at lower elevations ripening may be ahead compared to a more northern latitude and higher elevations. The harvesting time for seed of the different tree species varies greatly throughout the Philippines. Prof. DELIZO published an exact list containing the ripening time for about 250 Philippine tree species growing on the College of Forestry Campus in Los Baños (7). In another publication the same author recorded the seed availability of about 130 tree species throughout the country (8). According to his compilation seed of narra (*Pterocarpus indicus*) is available in the month of

|             |                   |
|-------------|-------------------|
| January     | in Nueva Ecija    |
| February    | La Union          |
| April       | Masbate           |
| May         | Ticao             |
| June        | Bulacan, Sorsogon |
| July        | Tarlac            |
| July/August | Laguna            |
| September   | Rizal, Mindoro    |

It is recommended to set up a calendar for each project indicating the month of seed maturity for all important species.

## 2.2 How to judge the maturity and quality of the fruit

To rely only on average ripening dates may not be sufficient.

We might come too late for species that hold their seed only a few days after maturity like Eucalyptus. Fruits and seeds should therefore be judged by personal inspection, when the presumptive time of seed collection approaches. The seed collector must be able to recognize when the fruit is mature.

After harvest, when the fruits are dried up for storage or shipment, it is often difficult to determine by outside appearance of the fruit, whether or not they have been collected in immature condition. Dried immature teak, narra, talisai and bitaog fruits do not differ from mature ones (8).

The quality of the fruit or seed should also be examined on the spot by cutting a few seeds with a knife to see, if they are infested by insects. This prevents the collector to take seed from a source with empty, unsound, pest-infested seed.

As the seeds mature, they lose their soft, milky condition and become firm. Cutting a pine cone will show, whether the seeds are still white and milky or already brown and firm.

Certain fruits dry up, like the pods of legumes and the capsules of eucalypts and mahogany. Fleshy fruits become soft when ripe like *Gmelina arborea*, molave, and edible fruits like mango, jackfruit, mabolo, santol.

An easily recognizable characteristic of ripeness is the change of color of the fruit, because in the ripening process the chlorophyll of the epidermis breaks down and other colors appear. The pods of the fire tree turn from green to dark brown, the fruit of *Gmelina arborea* from green to yellow, the drupe of molave from almost white to dark brown.

The cones of coniferous species, however, can already contain mature seeds, while their external appearance must not necessarily have changed. Actually they should be collected in "green" condition with their scales closed. When left on the tree until they become dry and change their color, it would be too late for collection, because the cones would have opened already to release their seeds. The maturity of closed cones suitable for collection can only be assessed by a cutting test.

### 2.3 Tools for Seed Collection

#### a) Equipment for climbing trees

- Climbing irons with spikes are useful for climbing trees without branches in the lower portion of the bole.
- Safety belts or ropes shall protect the climber from falling off the tree. A safety belt consists of a girdle, which is strapped around the waist, and a rope fastened to it. One end of the rope carries a hook, which can be hooked to a ring, after the rope has been placed around the trunk of the tree. In the tropics safety belts must be made of canvas, leather would quickly rot. They should be kept in good condition, because the life of the climber depends on them.
- Ladders are useful for collecting fruits or seeds from small trees, or help to reach the lower branches of taller trees. They can be made of light metal or wood. Preferable are models that fold or are extendible to facilitate transportation. Good and light ladders can be built by using bamboo poles for the side rails and hardwood for the rungs.

#### b) Tools for detaching fruits

- Extension pruners and similar implements: A long-handled extension pruner will enable the seed collector to reach even the furthest ends of the branches from his position in the crown, and there, detach the fruits or cut off the fruit-bearing branch without much difficulty. At times, the extension pruner enables the seed collector to reach fruits from the ground.
- "Cone pickers" are long-handled hand-shaped tools that serve well for breaking off pine cones. One of the "fingers" of the tool points towards the collector and allows him to draw near fruit-bearing branches. If this tool is not available, a useful substitute can be made from a hooked branch.
- Short-handled cutting tools such as bolos, pruning shears and pruning saws are useful to cut fruit-bearing twigs within reach.

- c) Containers: Fruits and seeds are first placed in handy small containers or receptacles, and then emptied into larger containers for shipment. Tarpaulins, plastic sheets or a canvas are sometimes spread under the seed trees to facilitate the collection of seeds or fruits from the ground. They also serve for drying the seeds before shipment.

### 2.4 Methods of Seed Collection

- a) Collecting from the ground: is only possible with large fruits that fall to the ground shortly after maturity. They should be picked up soon after falling to avoid deterioration and damage by insects and rodents. The fruits of the following species are usually gathered this way:
  - heavy, fleshy fruits: kaatoan bangkal, katmon, kamagong, santol, pangi;
  - medium-sized fruits with hard kernel: lumbang, baguiling, Gmelina, teak, talisai, kalumpit, bitaog, pili;
  - large pods: fire tree, rain tree, antsoan, sampalok, ipil, tindalo, dapdap;
  - large capsules: mahogany, kalumpang;
  - large winged fruits: narra, dipterocarps.
- b) Collecting from standing trees: Small seeds or fruits have to be collected from standing trees. These include the following:
  - small berries or drupes: malapapaya, molave;
  - minute seeds in capsules: Eucalyptus species, bottlebrush;
  - leguminous species, which open their pods on the tree: ipil-ipil, Moluccan sau, kamachile, tanglin;
  - small, winged, wind-disseminated seed: Benguet pine, Mindoro pine, Japanese alder, agcho, lanete, dita, African tulip, balsa, kalantas, banaba.

There are few people who can climb, and are willing to collect seeds from tall trees because of the risk involved. The common equipment are climbing irons. In the Philippines some

seed collectors climb barefooted or with the help of a rope, which ties both feet together and presses them against the trunk of the tree. All the tools needed are fastened to the safety belt at the back or pulled up by a string after the climber has reached the crown.

For the use of climbing irons the following instructions are given (13).

- Checking of equipment: spikes of the climbing irons, safety belt, rope;
- Decide on the climbing route when still on the ground, especially for the branchy crown region;
- Climb calmly with regular movements, make short steps;
- Hit the trunk with the spikes of the climbing iron in a slanting direction from above;
- Always use three points for a hold (2 feet and 1 hand or 1 foot and 2 hands);
- Do not press the upper part of the body and the knees against the trunk of the tree;
- In ascending the tree avoid dead branches and resin spots, break dry branches;
- When detaching fruits, have a safe stand by fastening the safety belt;
- Do not climb when it rains, when it is windy, or in darkness; also not when you are exhausted or tired,

c) Collecting from felled trees: Collecting seed from felled trees is the common practice for Benguet pine in Northern Luzon. As long as the cones are only taken from good mother trees, there are no objections against this cheap and convenient method.

### Chapter 3:

#### EXTRACTION OF SEED

The seeds of most tree species are enclosed in a fruit, from which they have to be extracted before shipment, storage or sowing. Seeds from fleshy fruits must be extracted immediately after collection.

If newly gathered fresh fruits of nearly all species are piled up or left undisturbed in sacks or cans, some heating and losses of viability will occur almost certainly. Pine cones left in a sack for more than three or four days often mould. Although moulding of the cone does not injure the seed, it makes extraction more difficult, because the scales will not open easily after drying.

Extraction of seed should be carried out at the central nursery of a reforestation project, where all the facilities for extraction, cleaning, drying and storage are concentrated, and where the work can be properly supervised. All the records concerning origin, quantity, date of collection and subsequent distribution and use of the seed are also kept here.

Regarding the extraction procedures, fruits can be divided into the following groups:

3.1 Seeds, which are sown as a fruit itself: This group includes teak, narra, dipterocarps. The coverings of teak can be removed by rubbing the seed lightly over a screen or between the hands. By winnowing, the coverings can be separated from the seed.

3.2 Fruits, which open when dry: This refers to the fruits of Eucalyptus species, Japanese alder, kalantas, mahogany,



banaba, ipil-ipil, agoho, Moluccan sau, kamachile. The fruits of these trees are spread in shallow layers on a dry surface like concrete floor, sawale mat, galvanized iron sheet, canvas or flat trays. Drying should not be forced by exposing the seed for a long time to direct sunlight, because the seeds may be damaged by overheating. Drying will be faster, if the layers are occasionally turned or stirred. Arrangements must be made to protect the seed from sudden rains. Large movable trays with a plywood bottom and legs are very suitable for drying large quantities of seed. When the weather turns unfavorable, they can be quickly moved under a shelter.

After the pods have opened, the seed will fall out. They can be easily cleaned by screening and winnowing. Pods and other fruits which do not readily release their seeds can be filled into a sack, which is then slightly beaten and tossed around. For every seed size one needs one screen with a mesh larger than the seeds to sort out the large impurities, and another one with smaller openings, which allow only the fine impurities to pass. Light matter can be removed by winnowing the seed on a tray.

3.3 Pods which do not open easily: Indehiscent hard pods, which are difficult to open, are found on the following species: Fire tree, rain tree, golden shower, antsoan, kupang. The pods of these species must be opened up with a bolo, and the seeds picked out individually. The pods of the rain tree are sweet and relished by termites. If they are piled in a dark place, after some time only the clean seeds will be left behind.

3.4 Pine cones (1,11,32): The cones of Benguet pine and Mindoro pine require more heat and a longer time to open than pods and capsules of broadleaved species. They should therefore be exposed to full direct sun in thin layers on a wire screen with a canvas below to catch the falling seeds. The drying racks are raked every day to accelerate drying and to free the seeds. The wings are removed from the seeds by rubbing them lightly over a screen or by filling them in a sack

and beating them with a soft flail until the wings are detached. Afterwards the wings are removed by winnowing.

3.5 Treatment of small fleshy fruits: Small fleshy fruits like molave are dried in a shaded place. To prevent fermentation they are spread in a thin layer and turned at least once a day. In drying the pulpy ectocarp shrivels surrounding the seeds with a protective cover. In this condition the seeds can be sown or stored.

3.6 Treatment of large fleshy fruits: This group includes the fruits of lumbang, bagilumbang, dao, pili, duhat, kamagong. The seeds are extracted right after collection to avoid fermentation and heating. Pulp and seeds can be separated by maceration. The fruits are filled into barrels or cans with water. After a day or two the pulp becomes soft. The fruits are then mashed carefully with a kind of tamper without crushing the seeds. When plenty of water is added the pulp will rise to the surface, while the seeds sink to the bottom. If only a small quantity of seed is wanted, it can be removed directly from the fruit. This applies particularly to edible fruits with large single seeds.

3.7 Extraction of kaatoan bangkal seed: Because of their minute size a special technique is required to extract the seeds from the fleshy fruit of kaatoan bangkal. The outer portion of the fruit, which contains the very fine seeds, is rubbed lightly against a  $\frac{1}{2}$  inch wire mesh. Then the pulp with the seeds is placed on a screen box with 1/16 inch mesh. While pouring water over the pulp and rubbing it carefully with the hands, the seeds together with the fine pulp will pass the screen and drop into a water-filled container below. The seeds will sink to the bottom of the container, while the fine pulp remains afloat. If the floating pulp still contains seeds, it will be returned to the screen box, and the separation procedure will be repeated. Afterwards the seeds are air-dried, impurities can be removed by winnowing (22).

STORAGE OF SEED

It would be ideal, if seeds are sown soon after their collection. This would be the way followed by nature. However, to do so is not always possible or convenient in practice. The date of sowing has to be timed, so that planting stock of proper size is available at the beginning of the planting season. Therefore it is important to know, how seeds can be stored without much loss of viability.

4.1 Longevity of seed: The rapidity by which seeds lose their viability after collection depends on the grade of maturity, on the species, and the conditions during storage. Seeds to be stored should be mature. Immature seeds deteriorate quickly during storage.

There are great differences in the longevity of seeds of the different tree species. Seeds with a hard impermeable seed coat, which protects the embryo from moisture and restricts the gaseous exchange, can be stored very long. Seeds of Indian lotus buried for 250 years in Manchurian peat bogs germinated perfectly when the impermeable seed coats were cracked (12).

Long-lived seeds do generally not germinate readily after maturity and after falling from the mother tree, but remain in the soil for some time until germination takes place. Often certain pretreatments have to be applied to overcome this dormancy (see chapter 8).

According to their longevity under normal atmospheric conditions the following three groups of species can be distinguished:

- Short-lived: Almaciga, binuang, most dipterocarps, mala-almaciga, champaca, mango;
- Seeds, which retain their viability for 3-6 months: Kaat-oan bangkal, mahogany, Gmelina arborea, Japanese alder, agoho, Mindoro pine, kalantas;
- Seeds, which retain their viability for one year or longer: Moluccan sau, narra, Benguet pine, Eucalyptus species, rain tree, Cassia, banaba, teak, ipil-ipil, akleng parang.

4.2 Atmospheric factors affecting seed storage

Seeds represent a dormant stage in the development of the plant. However, during this stage, life processes do not entirely cease. Respiration and transpiration still go on, though at a very slow pace. The more intense these life processes are, the more the viability of the seed will be lessened. Successful seed storage requires, that transpiration and respiration are reduced to the lowest possible degree. The following atmospheric factors regulate the internal life processes of the seed and must be considered in seed storage: temperature, moisture, light, and oxygen.

a) Temperature: All seed keeps better at relatively low temperatures. Low temperature reduces respiration and transpiration, and compensates to some extent the adverse effect of a higher moisture content. However, seed stored in the cold and subsequently moved to a warmer place loses rapidly its viability. Fluctuating temperatures are more unfavorable than a higher average temperature.

Dry seeds are able to survive temperatures below the freezing point, and, if the moisture content is continuously kept low, can be stored for many years in a refrigerator. Besides maintaining viability, low temperature storage automatically prevents insect damage.

b) Moisture: Moisture has a greater influence than temperature on maintaining the viability of stored seed. Seed to be



stored has to be sufficiently dry to prevent heating and moulding (12). A moisture content of about 6% is about the optimum for prolonged storage, because transpiration is then at its lowest. A slightly higher moisture content is allowable, if the temperature is close to the freezing point. There are a few species, especially fruit trees, such as jack-fruit, mabolo, chico, guava, pomelo, mango, which will lose their viability, if the moisture content becomes too low. Seed of these species must therefore be stored at temperatures near the freezing point.

The moisture content of seed varies with the relative humidity of the surrounding atmosphere. This fluctuating relative humidity can be harmful for sensitive seed in storage.

In practice, it is difficult to measure or determine the moisture content of seed without laboratory equipment. In the field, air-drying under the sun is a safe and simple way to reduce the moisture content before the seeds are sealed in a container. Pine seed can go into storage immediately after cleaning, because it has undergone thorough drying already in the process of extraction.

In sealed containers a permanently low moisture content can be maintained, if desiccating chemicals, like calcium oxide (CaO) or silica gel (silica oxide in the form of pellets, SiO<sub>2</sub>), are added to the seed lot (1). Both chemicals are available in drug-stores. They should be applied with caution, so that the moisture content will not be reduced below the critical point. In an experiment, 17 grams CaO have been found to be the correct amount for 100 grams of pine seed, which had been stored for 15 years at -4°C. Sometimes charcoal is used as a substitute.

- c) Light: According to studies in India and Indonesia some tree species like akleng parang, golden shower and ipil-ipil germinate best in full light (19). Thus, it can be assumed that light generally stimulates the life processes of seed, which should therefore be stored in the dark (26).

- d) Oxygen: The uptake of oxygen by the plants is called respiration. Respiration causes the oxydation (or burning) of reserves stored in the seed. To reduce the quantity of oxygen available for the stored seed, the containers should be filled completely and closed airtight. Experiments have shown, that the viability of para rubber seed was prolonged by storage in 45% carbon dioxide.

#### 4.3 Methods of Seed Storage

Proper storage should protect the seed from all factors that cause loss of viability during the interval between seed collection and sowing. These factors are the same that induce germination: high temperature, moisture, light, and oxygen. Besides this, the seed has to be protected from fungi and insects. Seed storage should therefore be carried out and take place

- at low temperature,
- under permanently low humidity,
- in the dark,
- in airtight containers.

- a) Storage without temperature control: Seeds with a hard seed coat can be stored in the open or in sacks without losing much viability for a number of months. This kind of storage is possible for teak, narra, Cassia species, Acacia species, lumbang, bagilumbang, fire tree, ipil-ipil, bitaog, akle, langil, supa and pili.

Fine, less resistant seed should be stored in sealed plastic bags or in airtight containers with a tightly fitting screw cap such as glass jars, bottles and cans. This kind of storage is recommended for Gmelina arborea, Japanese alder, agoho, Eucalyptus species, kalantas, Benguet pine and banaba.

For mahogany JACALNE (1955) recommends mixing the seeds with powdered charcoal and storing them in closed cans buried 40 cm under the ground in a shady place. By this method the seeds will not lose much of their viability, if they are not stored for a longer time than 4 months.

b) Storage at low temperatures: All less resistant seeds keep their viability much longer when stored at temperatures between 2 and 5°C and with a moisture content between 6 and 10% (for exceptions see chapter 4.2). Whether cold storage is economical, depends on the length of the intended storage and on the difficulty to maintain viability under normal temperatures. Generally, cold storage is recommended for storage periods over one year, except for the hard coated seeds listed under 4.3 a). The required low temperatures are produced by refrigerators or special cooling machines in seed storing chambers. The latter demand expensive equipment, but are necessary wherever much delicate seed is handled for a long-range reforestation program. Seed removed from cold storage must be sown immediately, otherwise it would deteriorate very soon. To avoid condensation of water, containers taken from cold storage must be brought to room temperature before they are opened. Cold storage is recommended for delicate seed such as Mindoro pine, kaatoan bangkal, almaciga and Chinchona. Mindoro pine can be expected to have lost all viability within 8 months when stored at room temperature. When kept at approximately 2°C, its germinative capacity will not deteriorate at all up to 14 months after collection (34). Kaatoan bangkal keeps viability in a refrigerator for 2 years (22).

## Chapter 5:

### SHIPMENT OF SEED

Loss of viability, while the seed is in transit, is mainly due to exposure to high temperatures and changes in moisture content. Very little can be done to regulate the temperature during transit. Some protection can be provided by insulating the seed lot with wood wool, paper, or similar materials. Moisture changes can be avoided by using plastic bags or sealed containers.

#### 5.1 Packing of Dry Seeds

Most seeds are shipped in dry condition. Delicate fine seed of agohe, bottlebrush, kaatoan bangkal, Alnus and Mindoro pine keeps best in transit when shipped in airtight containers or sealed in plastic bags with a small quantity of a desiccating chemical. For small long-lived seeds like Eucalyptus and Benguet pine a strong cloth bag would be sufficient. The seed containers have still to be wrapped in strong packing paper or placed into another more solid container like a cardboard box.

All long-lived hard coated seeds can be shipped in sacks. Despite their longevity such seeds should not be placed while in transit near boilers of ocean going vessels or other excessively hot places. A note written on the sack should prevent any such carelessness.

#### 5.2 Moist Seed Packing

This packing method is applied to short-lived seed like that of almaciga, para rubber and the dipterocarps (8). The seed is mixed with a moisture holding medium like moss, coconut fiber or sawdust, that has been moistened and then squeezed

dry. Pulverized charcoal has also proved to be a suitable packing medium. Almaciga packed in moist charcoal (200 grams water per 1 kg of charcoal, about 3/4 liter pulverized charcoal per 1 kg of seed) retained a viability of 50% after 4 weeks (21).

The seed together with the moist (not wet) packing medium is placed in alternate layers in a wooden box with perforated sides to allow ventilation. The interior of the box is lined out with burlap to prevent the seeds from falling through the holes (8). The seed must be sown immediately after arrival.

## Chapter 6:

### PROTECTION OF SEEDS FROM RODENTS AND INSECTS

#### 6.1 Rodents

Where damage of rodents is likely to occur, the seed must be stored in closed rooms with a wire netting over the ventilation openings. When it is stored in the open under a shelter, the storage compartments should be lined with a 1/4 inch wire netting. Seed kept in solid containers, like glass jars or cans, is well protected from rodents. Apart from preventive

measures damage by rodents can be controlled by using traps and rat poison baits.

#### 6.2 Insects

Some insects attack the seed while the fruits are still on the tree. This is very often the case with legumes. Harvesting is therefore recommended as soon as the seed becomes mature. Infested seeds can be separated by immersing the whole seed lot in water. The infested seeds will float on the surface.

Other insects, particularly weevils, attack harvested seed in storage. Even storage in closed containers does not provide complete protection, because some insects complete their full cycle inside the seed. A single living insect enclosed with the seed in the receptacle may cause a large portion or even the entire seed lot to be destroyed.

Insecticides against seed-eating insects can be applied by fumigation. Fumigation will not lessen the germinative capacity, if applied to really dry seeds. Fumigants can therefore only be applied to seeds that withstand drying. Carbon bisulphide is one of the common fumigants. Since it forms a gas heavier than air, the liquid is placed in a small dish or plate on top of the seed, from where the developing fumes will penetrate the seeds. The container must be kept tightly closed. A concentration of 1.8 grams carbon-bisulphide per 100 liters is recommended.

Methyl bromide is commonly used as a fumigant at quarantine stations. Tests have demonstrated the efficiency of methyl bromide fumigation at a rate of about 1.5 grams per 100 liters for 3 hours. No larvae survived this treatment, while untreated lots were infested by 40 %. Germination of the fumigated seed was satisfactory.

Paradichlorbenzene crystals commonly employed for the control of cloth moths are also very effective without impairing seed viability (1).

A simple and practical way to protect seed against insect attack is to spray the sacks from outside with insecticides or to "dust" the seeds in the containers with an insecticide in powder form.

## Chapter 7:

### TREATMENTS TO HASTEN GERMINATION

Seeds of the species listed below need a long time to germinate because of inherent dormancy and an almost impervious seed coat, which insulates the seed from its environment: teak, lumbang, baguilumbang, pili, talisai, bitaog, akle, langil, aroma, cutchtree, ipil, tindalo, Cassia species and supa.

With these species, it does not only take long until the first seedling appears, it will also take a long time until the last viable seed has germinated. This generally results in uneven sizes of seedlings and in an undesirably long exposure of sections of the bed surface.

Different pretreatment methods have been tried to hasten the germination of refractory tree seeds. Generally, the aim of such treatments is to overcome the inherent dormancy through the softening or breaking of the hard seed coat, so that moisture and oxygen can enter to induce germination.

#### 7.1 Cold Water Treatment

The seeds are soaked in tap-water of ordinary temperature until they have enlarged their size. This treatment is recommended after the seed has been nicked.

#### 7.2 Alternating Soaking and Drying

This method is sometimes applied to teak seed. The seed is soaked for 24 hours in running water, then spread out under the sun to dry, soaked again and so forth for about 2 weeks (19). In Thailand, after scarification (see below) or ant treatment alternate soaking and drying was applied to teak as an additional treatment, but with shorter intervals: 4 times soaking and 3 times drying, each for 30 to 45 minutes (5).

#### 7.3 Hot Water Treatment

Is applied especially to leguminous species to soften their horny seed coats. The seeds are immersed in boiling water, which has just been taken off the fire, or boiling water is poured over the seeds (26). The volume of water should be 5 to 10 times that of the seeds to keep the temperature of the water high as long as possible (34). The water with the seeds is left to cool, while the seeds are stirred repeatedly to remove the gelatinous skin (19).

#### 7.4 Chemical Treatments

Despite comparatively good results, pretreatment of seed with chemicals has not gained wide acceptance. The reasons are that the chemicals are expensive and not always available in the market, and, that the use of acids requires skill and carefulness on the part of the personnel (15).

Sulphuric acid ( $H_2SO_4$ ) has been employed to corrode thick seed coats. The length of the time the seeds have to be submerged in the acid depends on the nature of the seed coat. The progress of the acid treatment must be constantly watched. The treatment must be stopped, when the seed coat is paper-thin (8).

Ethyl-alcohol ( $C_2H_5OH$ ) and methyl-alcohol ( $CH_3OH$ ) of 90 to 100 percent have been found to stimulate germination of hard-coated seeds when soaked for 2 to 5 hours. Alcohol does not soften the testa, but penetrates the minute fissures, which water cannot enter unless alcohol precedes it (26).

#### 7.5 Scarification

This method aims to thin or abrade the horny testa to facilitate water absorption and permit gaseous exchange. Scarification can be tried by grinding the seeds individually (large seeds like lumbang) or by running them through a scarifier.

A number of scarifiers have been developed. One model consists of a vertical galvanized iron cylinder, in which a disk lined with sandpaper rotates on a steel shaft about 4 inches above the bottom also lined with sand paper. Through a feeder pipe, seed is filled into the space between the rotating disk and the bottom of the cylinder. The "mill" is motor-driven with a rotation speed of 500 to 900 rotations per minute. Scarifiers of this type are used in Thailand for the pretreatment of teak.

#### 7.6 Nicking and Similar Methods

Nicking means cutting the testa just enough to expose a small portion of the cotyledon. It is an appropriate method to treat large legume seed like ipil, tindalo, akle, supa, and other seed of similar nature. It is also the fastest method to determine the viability of these species (8).

Ipil seed is nicked at each end and a third time opposite to the point where the seed was attached to the pod (hilum). With a knife a small piece of the seed coat is chipped off without damaging the cotyledons. The nick opposite the hilum is very

important. Otherwise the cotyledons might be held together by a cap of the seed coat and the plumule would be unable to emerge. After treatment the seed is soaked in water for 24 hours, and then immediately sown.

#### 7.7 Complete Removal of the Seed Coat

Has been found to hasten the germination of bitaog seed markedly. Germination started already 22 days after sowing as compared with 57 days for untreated seeds, and lasted only 39 days as compared to 53 days without treatment (14). The germination of mango is also more uniform, when the testa is removed. The hard seed coat of tambulian has even to be cracked with a hammer (2).

#### 7.8 Burying of Seed in the Ground

Lumbang seed is dried after collection for three days under the sun. It is then placed alternately with ordinary garden soil in a container and covered with cogon. The container is put in the open and sprinkled with water every morning. After a week the shells of the seed begin to crack (8).

In India a similar technique is employed for teak. A square pit 80 cm deep and 1 m wide, which has been dug in well drained soil, is filled with water. When the water has disappeared, the sides are lined with teak leaves. The seed is soaked for 48 hours in direct sun, then placed into the pit in alternate layers with teak leaves, and finally covered with a 20 cm layer of earth. The seed, which is watered every day, is left in the pit for about 10 days before it is sown (19).

#### 7.9 "White Ant Treatment" of Teak Seed

According to BRYNDUM (1966), teak seed was spread on the ground in a 5 cm thick layer immediately after collection at the edge of a teak plantation and covered with cardboard. After about 5 weeks the testa of the seeds had been removed by white ants. Before sowing the seed was subjected to alternate wetting and drying (3 times 45 minutes each).

### 7.10 "Fire Treatment"

Lumbang seed can be treated the following way (14, 28): The nuts are spread evenly on the ground and covered with a 3 cm thick layer of dry cogon grass which is set on fire. As soon as the grass is burned, the seeds are placed into cold water. The quick change of temperature will cause the seed coat to crack.

Also the following modification is known: The lumbang nuts are sown in a seedbed at correct spacing with only half their diameter in the soil. A layer of cogon is spread over the seedbed and set on fire. After burning, the seedbed is sprinkled with water, and the seeds are pushed 2 cm deep into the ground and watered thoroughly.

## Chapter 8:

### QUALITY ASSESSMENT OF TREE SEED AND GERMINATION TESTS

All seed of a slightly doubtful or unknown quality should be tested before sowing or distribution. This applies especially to larger seed lots and seed, which has been stored for a long time.

### 8.1 Size and weight of seed

Relatively large seeds are usually of higher quality than smaller seeds. They possess a greater germinative power and produce more vigorous seedlings. In East Java, for example, only teak seed is sown that does not pass a 14 mm screen.

Often the provenances of a species differ in the average size of their seed. In this case, the seed size cannot be taken as a quality measure.

Fresh, fully developed, ripe seed is heavier than immature or very old seed. Generally, heavier seed has also a higher germinative energy. Clean seed is usually heavier than seed mixed with impurities (except sand), because these impurities, mainly wings, scales and similar matter, are lighter than the seed.

### 8.2 Determination of purity

The purity test determines the proportion by weight of pure seed in a seed lot. A purity percentage of 90 means that only 90% of the weight of the seed lot consists of pure seed, the remaining 10% are impurities. In a seed lot, the heavier foreign matter usually settles to the bottom while the lighter materials like fragments of leaves, wings, cone scales, etc. accumulate at the top. In order to get a representative sample, the following procedure is recommended:

The lot to be sampled is thoroughly mixed and placed on a flat surface forming a cone-shaped pile. The pile is carefully divided into four approximately equal parts. The process is repeated by similarly dividing one of the quarters until the original quantity of seed is reduced so much, that a proper sample is obtained. For small seeds 25 grams may be sufficient, for larger seeds up to 500 grams are required.

After weighing, the sample is spread on a sheet of white paper to facilitate the separation of seed and impurities. As impurities we consider pieces of broken and damaged seeds with less than one half of their original size, wings leaves, pieces of bark, twigs, soil, sand, stones, chaff, etc. (1). After



weighing either the pure seeds or the impurities, the purity percent can be calculated.

Generally, seed should be clean, but a certain amount of impurities is admissible in all seeds. The kind and amount of impurities generally tolerated varies with the species and depends on the expense and difficulty involved in cleaning the seed. All seeds that are easily separated from foreign matter are usually clean, but the purity percentage is correspondingly low for seed that is difficult to separate. Pine seed is easily cleaned and should therefore be pure. Seed of Eucalyptus is usually mixed with plenty of tiny chaff from the capsules, which is difficult to separate from the seeds, because it is of about the same size.

### 8.3 Determination of viability

- a) Inspection and cutting test: A number of seeds, preferably a multiple of hundred, is counted from a representative sample. The seed kernels are opened for inspection by cutting them with a sharp knife into halves. A sound kernel is firm, plump and has a sweet smell, the color is usually white. Rotten seed has a foul, rancid odor, is shrivelled and the cotyledon is usually discolored. Spots in the endosperm or in the embryo and abnormal softness indicate loss of viability. All seeds, in which the kernels have failed to develop, are "blind". A withered embryo or endosperm generally is a sign of overdrying. Endosperms or cotyledons in old seed gradually lose their white color and fresh appearance, the embryos shrivel and only partially fill the cavities. For this inspection, a hand lense would be very useful.

The percentage of healthy seeds gives a good indication of the germinative capacity of the examined seed lot.

The cutting test is particularly useful for a quick assessment of the viability of a seed lot, especially of larger seeds. Experiments with ipil-ipil, banaba and ipil have shown a close correlation between the results of cutting tests and the actual germinative capacity. It was found out, however, that the proportion of "healthy seeds" in a cutting test was 10 to 20 per-

cent higher than the number that actually germinated (14).

- b) Germination tests: During the germination test the selected seed sample is placed under optimal environmental conditions of temperature, moisture, light and oxygen (air) to induce germination. Since the food for the early growth is stored in the seed (cotyledons or endosperms respectively), it is not necessary for germination tests to have a particularly fertile soil as germination medium. Any material or medium, which provides moisture, warmth and air in close contact with the seed, can be used. Thus, humus, good garden soil or even pure sand would make suitable germination media.

Similarly useful is cotton (cloth test). A long piece of flannel or cotton cloth is spread on a plate in such a way that one end of the flannel can be suspended into a receptacle filled with water. The cloth will then constantly be kept moist by capillary action. The seeds to be tested are spread on the cloth and covered by a second piece of cotton. The same arrangement can be employed with blotting paper.

A more simple method is the use of a gunny sack. The seeds are spread on half of the sacks' surface, while the other half is folded over. From time to time the sack is sprinkled with water to maintain moisture.

Being subjected to favorable germination conditions the viable seeds of the sample under test will soon begin to germinate. The germinating seeds are constantly removed, the daily totals listed in a prepared form.

Germination tests have the disadvantage of requiring a certain time, usually 1-3 weeks or longer, depending on the species. They are seldom continued until all viable seeds have germinated. When the bulk of the seeds has already been removed, the test will be closed, and the viability of the yet ungerminated seeds estimated by a cutting test.

- c) Germinative energy: Not only the percentage of viable seeds in a seed lot is of interest, but also the course of germination.

After sowing, there will be always a lapse of time until the first seed germinates (pre-germination period). When germination starts, the seeds do not germinate all at once. At first only a few seedlings appear, then the bulk of them germinates, and finally some late-comers show up. Seeds of Benguet pine, for example, start germinating one week after sowing, and most of the viable seeds will have germinated within another week. The germination of 300 seeds, two years old, sown in a seed box was recorded as follows:

Count of germinated seeds

Sowing date: June 6, 1971

Germination:

| <u>Date</u>   | <u>Number</u> |
|---------------|---------------|
| June 11, 1971 | 4             |
| 12            | 20            |
| 13            | 32            |
| 14            | 60            |
| 15            | 50            |
| 16            | 21            |
| 17            | 10            |
| 18            | 9             |
| 19            | 6             |
| 20            | 4             |

Total: 216

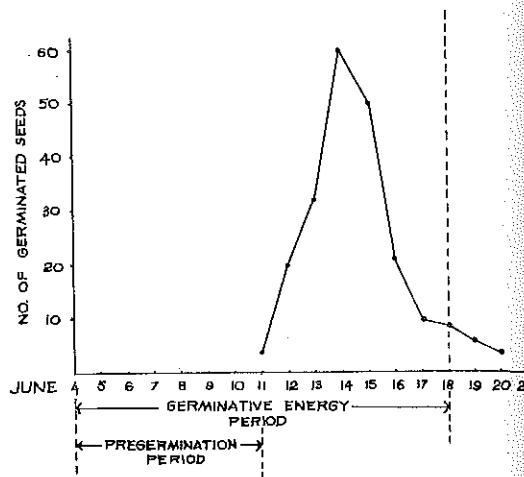

The course of germination of 2-year old Benguet pine seed

Eucalyptus shows about the same pattern of germination as Benguet pine, though the pregermination period is shorter. A steep parabola, like that shown above, is favorable, because the seed bed will be quickly covered by even-sized seedlings.

On the other hand, species like teak, lumbang and some legumes take a long time until the first seedling appears (2-4 weeks), and it may also take a long time until the last viable seed has germinated, sometimes several months. The reason probably is inherent dormancy and an impermeable seed coat. If the germination of these species is recorded graphically, the parabola will be flat covering a long period.

For the nursery this has serious disadvantages. The first seedlings can develop without competition and suppress those,

which germinate later, unless they are constantly transplanted. To avoid this, pretreatments as described in chapter 7 have to be employed.

Delayed germination can be the characteristic of the tree species, but it may also be caused by a decrease of vigor. The late germinating seeds often are not as fresh or healthy, nor do they have as much food reserves as the others. Most likely, they will not develop into seedlings as robust as the first ones to germinate.

If only vigorous, healthy seedlings are to be planted in the field, we should not count on these "stragglers". They would be rejected anyway when the planting stock undergoes culling. We can actually utilize only those seedlings that have germinated within a certain "reasonable" time, the "germinative energy period". It terminates with a rapid and constant falling off in daily germination. The percentage of seeds germinated during this period is expressed by the "germinative energy" which is lower than the germinative capacity.



THE TREE PERCENT AND ESTIMATES OF SEED REQUIREMENTS

In spite of all devotion, skill and care some of the seedlings will die after germination during their stay in the nursery due to adverse weather conditions, attack of fungus, nematodes, insects and rodents, or an inherent weakness of the embryo. The number of seedlings that is eventually produced is much smaller than the germinative capacity or the germinative energy would indicate. For calculating the quantity of seed needed to raise a certain number of seedlings one has to use lower figures.

The percentage of healthy seedlings fit for field planting, which can be expected from a given quantity of seed, is called tree percent. A tree percent of 50 means, that from a sample of 100 seeds only 50 will develop into plantable seedlings.

For example, Benguet pine with 90% germinative capacity may have a germinative energy of 80% and a tree percent of 60. Mahogany with a germinative capacity of 70% may have a tree percent of 50. As a general rule tree percent and germinative energy or germinative capacity are much closer together for species with larger seeds than for species with small seeds.

The tree percent not only lags behind the germinative energy, but decreases progressively with deteriorating seed quality. The lower the germinative energy, the greater the gap between the proportion of seeds that germinate and those which grow into plantable seedlings. Therefore, low grade seed is much less valuable than the standard germination tests point out. On the other hand, the higher the seed quality the nearer the tree percentage corresponds with the results from the germination tests.

To illustrate this, the out-put of seedlings of two seed samples with different germinative capacity and tree percent are compared:

## - Benguet pine

Number of seeds per liter ..... 30 000  
 Purity percent ..... 95%  
 Germinative capacity ..... 90%  
 Tree percent ..... 60%

Number of seedlings/liter of seed =  $30\ 000 \times .95 \times .60$   
 = 17 100 seedlings

## - Benguet pine

Purity percent ..... 95%  
 Germinative capacity ..... 60%  
 Tree percent ..... 30%

Number of seedlings/liter of seed =  $30\ 000 \times .95 \times .30$   
 = 8 550 seedlings

The most viable seed is generally the fully matured, fresh seed. Here not only the germinative capacity is highest, but almost all viable seed will develop into robust, vigorous seedlings. Not so with seed of weakened viability because of gathering before maturity, improper handling after collection, too long or inadequate storage, or injurious pretreatment to hasten germination. Its germinative capacity is not only lower than that of fresh seed, but the viability of the seeds actually germinating is impaired. Frequently the embryo is weak, does not develop normal roots, and soon dies. Or, a thin, poor seedling appears, but is likely to be destroyed by fungus diseases or insects because it lacks resistance.

The tree percentage, therefore, is the most valuable indication of seed quality for the practical nursery man. He can use it together with the purity percent and the number of seeds per liter or per kilo to calculate the number of plantable seedlings that he can expect to raise from a kilo or liter of seed under average nursery conditions. It is recommended that data on tree percentages for the important reforestation species are made available for nursery men.

Most of the following data were derived from counts made by the RESEARCH DIVISION of the BUREAU OF FOREST DEVELOPMENT and from various FAO publications (11,19,21,24,33)

| Species                               | Seeds/kilo      | Seeds/liter       |
|---------------------------------------|-----------------|-------------------|
| Acacia auriculaeformis                | 63 000          | 49 000            |
| Acacia catechu                        | 32 000 - 35 000 | not available     |
| Acacia farnesiana                     | 10 000 - 12 000 | not available     |
| Agathis philippinensis                | 6 000 - 8 000   | 2500              |
| Albizzia acle                         | 240             | 450               |
| Albizzia falcata                      | 42 000          | 27 000 - 34 000   |
| Albizzia julibrissin                  | 160 000         | 130 000 - 139 000 |
| Albizzia lebbek                       | 7000 - 9000     | no data           |
| Albizzia procera                      | no data         | 20 000            |
| Aleurites moluccana                   | no data         | 60                |
| Aleurites trisperma                   | no data         | 70                |
| Alnus maritima                        | 120 000         | 22 000            |
| Anthocephalus chinensis               | 2 600 000       | 1 500 000         |
| Anacardium occidentale                | 150             | no data           |
| Bauhinia acuminata                    | no data         | 8 800             |
| Bauhinia monandra                     | no data         | 4 200             |
| Bauhinia purpurea                     | 4 100           | 3 600             |
| Bischofia javanica                    | no data         | 1 900             |
| Bombycidendron vidalianum             | no data         | 1 500             |
| Callistemon lanceolata                | 19 000 000      | 7 600 000         |
| Calophyllum inophyllum                | no data         | 78                |
| Cassia fistula                        | 5 500           | 5 600             |
| Cassia javanica                       | 8 400           | 7 600             |
| Cassia siamea                         | 35 000 - 37 000 | 23 900            |
| Cassia spectabilis                    | no data         | 27 500            |
| Casuarina equisetifolia<br>with wings | 770 000         | 130 000           |
| without wings                         | no data         | 700 000           |
| Casuarina montana (w/o wings)         | no data         | 300 000           |
| Ceiba pentandra                       | 19 000          | 6 400             |
| Cryptomeria japonica                  | 300 000         | 112 000           |
| Delonix regia                         | 2000            | 1 500             |

| Species                             | Seeds/kilo        | Seeds/liter                       |
|-------------------------------------|-------------------|-----------------------------------|
| Diospyros discolor                  | no data           | 130                               |
| Dracontomelon dao                   | no data           | 900                               |
| Endospermum peltatum                | no data           | 9 800                             |
| Eucalyptus camaldulensis            | 7 300 000         | 3 000 000                         |
| Eucalyptus deglupta                 | 23 000 000        | 6 800 000                         |
| Eucalyptus grandis                  | 12 000 000        | no data                           |
| Eucalyptus robusta                  | 7 000 000         | 3 700 000                         |
| Eucalyptus saligna                  | 1 000 000         | 5 800 000                         |
| Eucalyptus tereticornis             | 6 600 000         | 3 300 000                         |
| Fragraea fragrans                   | 5-6 Mill.         | no data                           |
| Gliricidia sepium                   | no data           | 3 000                             |
| Gmelina arborea                     | 1 800             | 880 - 960                         |
| Hevea brasiliensis                  | no data           | 130                               |
| Intsia bijuga                       | no data           | 190                               |
| Lagerstroemia speciosa              | 160 000 - 230 000 | 10 000                            |
| Leucaena glauca                     | 22 000            | 17 000 - 19 000                   |
| Michelia champaca                   | 10 000            | no data                           |
| Ochroma pyramidale                  | no data           | 104 000                           |
| Octomelis sumatrana                 | ca. 3.5 Mill.     | no data                           |
| Pahudia rhomboidea                  | no data           | 180                               |
| Parashorea plicata                  | no data           | 29                                |
| Parkia javanica                     | 1 000 - 1 200     | no data                           |
| Pentacme contorta                   | no data           | 23                                |
| Pinus insularis                     | 55 000 - 63 000   | 26 000 - 34 000<br>average 30 000 |
| Pinus merkusii                      | 40 000            | 18 000                            |
| Pithecolobium dulce                 | 5 500 - 8 800     | no data                           |
| Pterocarpus indicus                 | 1 200 - 1 300     | 110                               |
| Samanea saman                       | 4 400 - 7 700     | 4 500                             |
| Sindora supa                        | no data           | 600                               |
| Spathodea campanulata               | no data           | 5 600                             |
| Swietenia macrophylla with<br>wings | 1 600 - 2 000     | 90                                |
| without wings                       | 3 500             | 200                               |
| Tamarindus indicus                  | 880 - 990         | 840                               |
| Tectona grandis, cleaned            | 1 500 - 2 000     | 300 - 400                         |
| not cleaned                         | 1 000             | 170                               |
| Terminalia catappa                  | 24                | no data                           |
| Toona calantas                      | 280 000 - 420 000 | 100 000                           |
| Vitex parviflora, dried             | 19 000            | 11 000                            |

## REFERENCES

1. BALDWIN, H.I., 1955, Handling forest tree seed. FAO, Rome
2. BARNARD, R.C., 1969, A manual of Malayan silviculture for lowland forests. Part IV: Artificial Regeneration, Kuala Lumpur
3. BINUA, T.M., 1962, Modern practical techniques and economical practices of reforestation. Forestry Leaves 13 (2), Los Baños
4. BROWN, W.H., 1935, The plant kingdom. Ginn & Co., Boston
5. BRYNDUM, K., 1966, The germination of teak. Nat. Hist. Bull. of the Siam Society Vol. 21 (122), Bangkok
6. Buszewicz, G., 1969, Problems and rewards in processing and storing seed. Journal of Forestry 63 (2), London
7. DELIZO, T.C., 1962, Seed production forecast for the Mt. Makiling College Forest of the College of Forestry. For. Leaves 13 (2)
8. DELIZO, T.C., 1964, Forest nursery and plantation handbook for the Philippines. U.P. College of Forestry, Los Baños
9. DOMINGO, J.L., 1968, How to raise Albizzia falcata. For. Pop. Bull. 1, U.P. College of Forestry, Los Baños
10. FAO, 1959, Pine cone drying rack. Forestry Equipment Notes, Rome
11. GOOR, A.Y., 1963, Tree planting practices for arid zones. FAO, Rome
12. HARTMAN, H.T. et KESTER, D.E., 1959, Plant propagation. Prentice Hall, Inc. Eaglewood Cliffs, N.J.
13. ISSLEIB, G., 1964, Unfallverhütung beim Besteigen von Waldbäumen. Allg. Forst Zeitschrift 19 (12/13), München
14. JACALNE, D.V., 1955, Summary of some germination studies in the Division of Forest Investigation. Phil. Journal of Forestry 11 (3 & 4),
15. JACALNE, D.V., 1959, Further study on hastening the germination of akle seed. Phil. Journal of Forestry 15 (1-4)
16. JUNI, A.A., 1962, Better trees for tomorrow. For. Leaves 14 (1 & 2)
17. KRÜSSMANN, G., 1964, Die Baumschule, Paul Parey, Hamburg
18. LEROY, J., 1962, Recommendations for successful storage of tree seed. Tree Planters Notes No. 55, US Forest Service
19. LETOURNEUX, C., 1957, Tree planting practices in tropical Asia. FAO, Rome
20. LIMSTROM, G.A., 1965, Interim forest tree improvement guides for the Central States. US Forest Service
21. MAGINI, E. et TULSTRUP, N.P., 1955, Tree seed notes. FAO, Rome
22. MONSALUD, M.R. et LOPEZ, F.R., Kaatoan bangkal (Anthocephalus cadamba miq.). Mimeographed, Los Baños
23. PAA, N.F. et GERARDO, J., 1967, Silvicultural characteristics of kaatoan bangkal. For. Leaves 13 (1 & 2), Los Baños
24. PARRY, M.S., 1956, Tree planting practices in tropical Africa. FAO, Rome
25. RATANAKOSES SURAPAT, 1967, Storing of teak seed. Thai-Danish Teak Improvement Center, Maehuat, Thailand
26. Rayos, J.A., GLORI, C.V., ESTEBAN, I.D., 1964, Vital information on seed handling with emphasis on reforestation. Lumberman 10 (1), Manila
27. REFORESTATION ADMINISTRATION, Annual report 1968/69, Manila
28. REFORESTATION ADMINISTRATION, Planting instructions for some forest trees in the Philippines. Mimeographed, Manila
29. RUPF, H., SCHÖNHAR, S., Zeyher, M., 1961, Der Forstpflanzgarten, München
30. SURI, P.N. and SETH, S.K., 1959, Tree planting practices in temperate Asia. FAO, Rome
31. TADEO, C.B., 1962, Silvicultural characteristics of bagtikan (Parashorea plicata). Lumberman 8 (6), Manila
32. TOUMEY, J.W. et KORSTIAN, C.F., 1942, Seeding and planting in the practice of forestry. 3rd. Ed., New York
33. WORMALD, T.J., 1969, A nursery handbook for the Philippines. Reforestation Administration Manila, mimeographed.
34. WORMALD, T.J., 1969, Experiments undertaken in cooperation with the Research Officer. Reforestation Administration Manila, mimeogr.

P A R T VII

INDEX TO COMMON AND SCIENTIFIC NAMES

a) INDEX TO COMMON NAMES

- Acacia (Raintree),  
*Samanea saman* (Jacq.) Merr.,  
 60, 67, 179, 507, 510, 513,  
 533
- African tulip,  
*Spathodea campanulata* Beauv.,  
 66, 75, 256, 263, 313, 507, 533
- Agoho,  
*Casuarina equisetifolia* Forst.,  
 23, 50, 53, 54, 74, 76, 120,  
 178, 232, 250, 256, 269, 287,  
 289, 362, 488, 507, 509, 513,  
 515, 517, 532
- Agoho del Monte,  
*Casuarina rumphiana* Mig., 53, 54
- Akle,  
*Albizia acle* (Blanco) Merr.,  
 257, 515, 520, 522, 532
- Akleng-parang,  
*Albizia procera* (Roxb.) Benth.,  
 50, 52, 111, 113, 178, 185, 488,  
 513, 514, 532
- Alibangbang,  
*Bauhinia malabarica* Roxb., 50,  
 53, 75, 185, 193
- Almaciga,  
*Agathis philippinensis* Warb.,  
 syn. *A. alba* (Lam.) Foxw., 51,  
 71, 111, 513, 516, 517, 518, 532
- Almon,  
*Shorea almon* Foxw., 18, 19
- Alupag,  
*Euphoria didyma* Blanco
- Amugis,  
*Koordersiodendron pinnatum*  
 (Blanco) Merr.
- Anabiong,  
*Trema orientalis* Blume
- Anang,  
*Diospyros pyrrocarpa* Mig.
- Anipai (Tapilan),  
*Phaseolus calcaratus* Roxb., 337
- Antipolo,  
*Artocarpus blancoi* (Elm.) Merr.
- Antsoan,  
*Cassia javanica* L., 75, 178, 185,  
 488, 507, 510, 513, 515, 520, 532.
- Antsoan-dilau,  
*Cassia spectabilis* L., 75, 185,  
 488, 513, 515, 520, 532
- Anubing,  
*Artocarpus cumingiana* Tréc.
- Api-api,  
*Avicennia officinalis* Linn.  
 22
- Apitong,  
*Dipterocarpus grandiflorus*  
 Blanco, 18, 19, 20, 133
- Aranga,  
*Homalium foetidum* (Roxb.) Benth.
- Arbor vitae,  
*Thuja orientalis* L., 76, 265
- Aroma,  
*Acacia farnesiana* (L.) Willd.,  
 50, 51, 120, 238, 488, 515,  
 520, 532
- Bagilumbang,  
*Aleurites trisperma* Blanco, 52,  
 113, 507, 511, 515, 520, 522,  
 532
- Bagras,  
*Eucalyptus deglupta* Blume, 44,  
 50, 56, 65, 66, 93, 533
- Bagtikan,  
*Parashorea plicata* Brandis, 18,  
 19, 111, 112, 133, 533
- Bakauan,  
*Rhizophora candelaria* DC.  
*Rhizophora mucronata* Lam., 22
- Balete,  
*Ficus* spp. Linn., 76, 185
- Balitbitan,  
*Cynometra ramiflora* L.
- Balsa,  
*Ochroma pyramidale* Cav. ex.  
 Lam., syn. *O. lagopus* Sw.,  
 507, 533
- Bambang,  
*Bauhinia acuminata* L., 532
- Bamboos,  
*Bambuseae*, 72, 238
- Banaba,  
*Lagerstroemia speciosa* (L.)  
 Pers., 50, 75, 111, 121, 185,  
 256, 467, 488, 507, 509, 513,  
 515, 526, 533
- Bangkal,  
*Nauclea orientalis* L., 426

Bangkal, southern  
*Nauclea junghuhnii* (Mig.)  
 Merr., 426

Banlag,  
*Xylopiia ferruginea* Baill.,

Banuyo  
*Wallaceodendron celebicum*  
 Koord., 21

Baston de San Jose,  
*Cordyline terminalis* Kunth.,  
 76, 263

Batau (Hyacinth bean),  
*Dolichos lablab* Linn., 416

Batete,  
*Kingiodendron alternifolium*  
 (Elm) Merr. & Rolfe

Batitanin,  
*Lagerstroemia piriformis* Koehne

Benguet pine,  
*Pinus insularis* Endl., syn. *P.*  
*khasya* Royle, 23, 24, 44, 50,  
 58, 59, 65, 66, 81, 97, 104,  
 149, 179, 182, 183, 188, 189,  
 197, 232, 250, 256, 257, 260,  
 269, 287, 362, 374, 425, 503,  
 507, 508, 510, 513, 515, 528,  
 530, 531, 533

Bermuda grass,  
*Cynodon dactylon* (L.) Pers.,  
 427

Betelnut palm,  
*Areca catechu* Linn., 76

Betis,  
*Madhuca betis* (Blanco)  
 Macbh. & Merr.

Bikal,  
*Schizostachyum diffusum* (Blanco)  
 Merr., 146

Binuang  
*Octomelis sumatrana* Mig., 44,  
 66, 93, 513, 533

Bitanghol (Palomaria de Monte),  
*Calophyllum blancoi* Bl. & Fr.

Bitag,  
*Calophyllum inophyllum* L., 23,  
 50, 53, 120, 505, 507, 515, 520,  
 523, 532

Boho,  
*Schizostachyum lumampao* (Blanco)  
 Merr., 70, 275, 426, 488

Boton  
*Barringtonia asiatica* (L.) Kurz

Bottlebrush  
*Callistemon lanceolatus* DC., 75,  
 76, 256, 362, 507, 517, 532

Bougainvillea  
*Bougainvillea spectabilis* Willd.,  
 76, 240, 263

Bulacan,  
*Merremia peltata*, 146

Buri,  
*Corypha elata* Roxb., 71, 76

Bunya pine,  
*Araucaria bidwillii* Hook

Caimito (Star apple),  
*Chrysophyllum caimito* Linn.  
 488

Camagon (Mabolo, Kamagong),  
*Diospyros philippinensis*  
 (Desr.) Gurke  
*Diospyros discolor* Willd.,  
 21, 488, 505, 507, 511, 514,  
 533

Camote (Sweet potatoes),  
*Ipomoea batatas*, 127

Cafia fistula (Golden shower),  
*Cassia fistula* L., 44, 75,  
 111, 160, 185, 488, 510, 513,  
 514, 515, 520, 532

Cashew (Casoi),  
*Anacardium occidentale* L.,  
 44, 50, 113, 178, 193, 373,

Casoi (Cashew),  
*Anacardium occidentale* L.,  
 44, 50, 113, 178, 193, 373,  
 488, 532

Cassava,  
*Manihot utilissima*, 126, 127,  
 128

Centrosema,  
*Centrosema pubescens* Benth.,  
 416, 426, 467

Champaka,  
*Michelia champaca* L., 513, 533

Chico,  
*Manilkara zapota* (L.) Van  
 Royen, 514

China-fir,  
*Cunninghamia konishii* Hayata,  
 50

Coconut palm,  
*Cocos nucifera* Linn., 76

Cogon,  
*Imperata cylindrica* Beauv., J.  
*exaltata* Brongn., 85, 94, 118,  
 123, 142, 144, 165, 197, 234,  
 279, 298, 408, 409

Conifers,  
 144, 149, 306, 326, 500, 505

Corn (Maize),  
*Zea mays* L., 126, 127

Cowpea,  
*Vigna sinensis* (Linn.) Savi,  
 337

Cutchtree,  
*Acacia catechu* (L.F.) Willd.,  
 515, 520, 532

Dalingdingan,  
*Hopea foxworthyi* Elm., 19

Dallis grass,  
*Paspalum dilatatum* Poir., 416

Dao,  
*Dracontomelon dao* (Blanco)  
 Merr. & Rolfe, 511, 533

Dapdap,  
*Erythrina variegata* Linn.,  
 var. *orientalis* (L.) Merr.,  
 75, 507

Dipterocarps, (Philippine mahogany)  
*Dipterocarpaceae*, 18, 19, 20,  
 54, 81, 94, 111, 133, 135, 191,  
 232, 259, 287, 503, 507, 509,  
 513, 517

Dita,  
*Alstonia scholaris* (L.) R. Br.,  
 111, 185, 507

Duguan,  
*Myristica philippensis* Lam.

Duhat,  
*Syzygium cumini* (L.) Skeels, 511

Dumanay  
*Homonoia riparia* Lour., 426, 470

Dufigon,  
*Tarrietia sylvatica* Merr.

Dufigon-late,  
*Heritiera littoralis* Dryand., 23

Durian,  
*Durio zibethinus* Murr.

Elephant grass,  
*Pennisetum purpureum* Schum., 198

Eucalypts (Gum trees)  
*Eucalyptus* spp. Benth. and Muell.  
 44, 50, 74, 84, 97, 142, 232,  
 233, 250, 256, 269, 287, 289,  
 362, 498, 505, 507, 509, 513,  
 515, 517, 526, 528

Firetree,  
*Delonix regia* (Boj.) Raf., 75,  
 178, 505, 507, 510, 515, 532,

Fringon,  
*Bauhinia monandra* Kurz., 185, 532

Gabi (Taro)  
*Colocasia esculenta*, 128

Gardenia,  
*Gardenia jasminoides* Ellis,  
 76

Giant ipil-ipil,  
*Leucaena leucocephala* (Lam.)  
 de Wit, 58, 68

Gisok,  
*Shorea astylosa* Foxw., 19

Gisok-gisok,  
*Hopea philippinensis* Dyer, 19

Golden shower (Caña fistula),  
*Cassia fistula* L., 44, 75,  
 111, 160, 185, 488, 510, 513,  
 514, 515, 520, 532

Gubas,  
*Endospermum peltatum* Merr.,  
 55, 66, 287, 533

Guinea grass,  
*Panicum maximum* Jacq., 198

Gumamela,  
*Hibiscus* spp. Linn. 76, 185,  
 263

Guava,  
*Psidium guajava* L., 44, 50,  
 60, 426, 514

Hagakhak,  
*Dipterocarpus warburgii*  
 Brandis, 19, 20, 21

Himbabao,  
*Alleanthus luzonicus* (Blanco)  
 F. Vill.

Hyacinth bean (Batau),  
*Dolichos lablab* Linn., 416

Igem,  
*Podocarpus imbricatus*, syn.  
*P. javanicus*, 75

Ilang-ilang,  
*Cananga odorata* (Lam) Hook.  
 f. & Th.

Ipil,  
*Intsia bijuga* (Colebr.) O.  
 Ktze. 21, 257, 313, 507, 520,  
 522, 526, 533

Ipil-ipil,  
*Leucaena leucocephala* (Lam.)  
 de Wit, Syn. *L. glauca*, 44, 50,  
 58, 67, 68, 72, 74, 81, 84, 104,  
 113, 114, 188, 198, 233, 240,  
 263, 416, 425, 436, 447, 478,  
 488, 507, 509, 513, 514, 515,  
 526, 533

Jacaranda,  
Jacaranda mimosaeifolia D. Don,  
75

Jackfruit (Nangka),  
Artocarpus heterophylla Lam.,  
193, 505, 514

Japanese alder,  
Alnus maritima Nuttall, 44, 50,  
53, 72, 81, 97, 104, 256, 289,  
322, 425, 507, 509, 513, 515, 517,  
532,

Japanese cypress,  
Cryptomeria japonica (L.F.)  
D. Don., 50, 54, 75, 256, 263,  
265, 289, 532

Jatoba,  
Hymenaea courbaril L.

Junipers,  
Juniperus spp., 265

Kaatoan bangkal,  
Anthocephalus chinensis (Lamk.)  
Mig., 44, 50, 53, 66, 84, 93,  
97, 232, 250, 256, 257, 287,  
362, 364, 503, 507, 511, 513,  
516, 517, 532

Kakauati (Madre de cacao),  
Gliricidia sepium (Jacq.) Steud.,  
44, 50, 57, 68, 72, 74, 233, 240,  
263, 425, 447, 478, 488, 533,

Kalachuchi,  
Plumeria acuminata Ait., 75, 263

Kalantas,  
Toona calantas Merr. Rolfe, 21,  
44, 45, 50, 62, 104, 193, 256,  
507, 509, 513, 515, 533

Kalumpang,  
Sterculia foetida L., 507

Kalumpit  
Terminalia edulis Blanco, 507

Kamachile,  
Pithecolobium dulce (Roxb.)  
Benth., 50, 59, 238, 239, 426,  
488, 507, 509, 533

Kamagong (Camagon, Mabolo),  
Diospyros philippinensis (Desr.)  
Gurke, discolor Willd., 21, 488,  
505, 507, 511, 514, 533

Kamatog,  
Erythrophloeum densiflorum Merr.

Kaong,  
Arenga pinnata (Wurmb.) Merr.

Kapok,  
Ceiba pentandra (L.) Gaertn., 532

Kariskis  
Albizzia lebbekoides (DC) Benth.,  
52

Kassod tree (Siamese Acacia)  
Cassia siamea Lam., 68, 75,  
111, 113, 178, 185, 488,  
513, 515, 520, 532

Katmon,  
Dillenia philippinensis  
Rolfe, 507

Katurai,  
Sesbania grandiflora (Linn.)  
Pers., 61, 67, 198, 240

Kawayan,  
Bambusa spinosa Roxb., 69  
426, 488

Kawayan-kiling,  
Bambusa vulgaris Schrad., 69,  
426, 488

Kikuyu grass,  
Pennisetum clandestinum  
Hochst, 416, 427

Kudzu,  
Pueraria phaseoloides (Roxb.)  
Benth., 337, 416, 426, 467

Kudzu,  
Pueraria thunbergiana Benth.,  
syn. P. hirsuta Schneider,  
426, 467

Kupang,  
Parkia javanica (Lam.) Merr.  
510, 533

Lanete,  
Wrightia laniti (Blanco)  
Merr., 507

Lamio,  
Dracontomelon edule (Blanco)  
Skeels

Lañgil  
Albizzia lebbek (L.) Benth.  
515, 520, 532

Lantana,  
Lantana camara Linn., 72,  
76, 185, 240, 263, 426, 488

Lanutan,  
Bombycidendron campylosiphon  
Warb.

Legumes,  
Leguminosae, 68, 287, 322,  
336, 337, 416, 424, 505, 519,  
521, 528

Lespedeza, perennial  
Lespedeza cuneata G. Don 416,  
426,

Limba,  
Terminalia superba

Lipai,  
Mucuna nigricans (Lour.)  
Steud., 426

Loktub,  
Duabanga moluccana, 66

Lumbang,  
Aleurites moluccana (L.) Willd.,  
40, 52, 71, 113, 124, 178, 254,  
257, 507, 511, 515, 520, 522,  
523, 524, 528, 532

Lumbayao,  
Tarrietia javanica Blume

Mabolo (Camagon, Kamagong),  
Diospyros philippinensis (Desr.)  
Gurke, Diospyros discolor Willd.,  
21, 488, 505, 507, 511, 514, 533

MacArthur palm,  
Actinophloeus macarthurii  
(H. Wendl.) Becc., 76

Macopa,  
Eugenia javanica Lam., 24, 185

Madre de cacao (Kakauati),  
Gliricidia sepium (Jacq.) Steud.,  
44, 50, 57, 68, 72, 74, 233, 240,  
263, 425, 447, 478, 488, 533

Maguey,  
Agave cantala Roxb., 426

Mahogany,  
Swietenia spp., 81, 84, 94, 97,  
104, 133, 135, 187, 188, 232, 250,  
254, 257, 259, 269, 289, 303, 313,  
505, 507, 509, 513, 515, 530

Mahogany, large leaf,  
Swietenia macrophylla King, 44,  
50, 61, 65, 533

Mahogany, small leaf,  
Swietenia mahogany Jacq., 50, 61

Maize (corn),  
Zea mays L., 126, 127

Malaalmaciga,  
Podocarpus blumei Endl., 75, 513

Malaanonang,  
Shorea polita Vid., 19

Malakaturai,  
Cassia multijuga Reichb., 75,  
185, 488, 513, 515, 520

Malakmalak,  
Palaquium philippinensis (Perr.)  
C. B. Rob.

Malapapaya,  
Polyscias nodosa (Blume) Seem.,  
507

Malaruhat,  
Cleistocalyx operculatus  
Merr. & Perry

Malugai  
Pometia pinnata Forst.

Malungay,  
Moringa oleifera Lam., 240

Manggachapui  
Hopea acuminata Merr., 19

Manggasinoro,  
Shorea philippinensis  
Brandis, 18, 19

Manggis,  
Koompassia excelsa Faub.

Mango,  
Mangifera indica L., 58,  
178, 185, 193, 505, 513, 514

Martinez's palm,  
Martinezia caryotaefolia HBK.

Mayapis,  
Shorea squamata Dyer, 18, 19,  
111, 133

Melastoma family,  
Melastomataceae, 185

Melina (Yemane),  
Gmelina arborea (Linn.) Roxb.,  
44, 50, 57, 65, 66, 73, 84,  
97, 110, 111, 127, 160, 185,  
232, 250, 254, 257, 258, 263,  
313, 488, 505, 507, 513, 515,  
533

Mexican cypress,  
Cupressus lusitanica Mill.,  
75, 76, 256, 265

Mexican sunflower,  
Helianthus tuberosus L., 72,  
426, 428, 447, 488

Mindoro pine,  
Pinus merkusii Jungh. & De  
Vr., 23, 59, 97, 162, 171  
321, 503, 504, 507, 510, 513,  
516, 517, 533

Molave,  
Vitex parviflora Juss., 21,  
44, 45, 50, 63, 104, 185,  
232, 239, 287, 488, 505, 507,  
511, 533

Moluccan sau,  
Albizzia falcataria (L.),  
Back., 50, 52, 61, 65, 66,  
81, 84, 93, 97, 124, 178,  
185, 232, 250, 507, 509, 513  
532

Mulberry spp.,  
Morus spp. Tournef., 84, 185,  
263

Mulberry family,  
Moraceae, 190

Mungo bean,  
Phaseolus aureus Roxb., 337



Nangka (Jackfruit),  
*Artocarpus heterophylla* Lam.,  
 193, 505, 514

Narek,  
*Balanocarpus cagayanensis*  
 Foxw.

Narig,  
*Vatica manggachapui* Blanco, 19

Narra  
*Pterocarpus* spp., 21, 44, 45, 50,  
 60, 73, 83, 84, 97, 104, 232,  
 250, 254, 257, 269, 289, 313,  
 488, 504, 505, 507, 509, 513, 515

Narra, prickly,  
*Pterocarpus vidalianus* Rolfe,  
 60, 65

Narra, smooth  
*Pterocarpus indicus* Willd.,  
 60, 65, 153, 179, 533

Nato,  
*Palaquium luzoniense*  
 (F.-Villd.) Vid.

Nipa palm,  
*Nipa fruticans* Wurm., 22

Norfolk Pine  
*Araucaria excelsa* (Lamb.)

Oaks,  
*Quercus* spp., 24

Oleander  
*Nerium indicum* Mill., 263

Oliva,  
*Cycas revoluta* Thunb.

Palmera,  
*Chrysalidocarpus lutescens*  
 H. Wendl.

Palms,  
 Palmae, 76

Palomaria del Monte (Bitanghol),  
*Calophyllum blancoi* BL. & Fr.

Palosanto,  
*Triplaris cumingiana* Fisch.  
 & Mey.

Palosapis,  
*Anisoptera thurifera* (Blanco)  
 Blume, 18, 19

Pandans (Screw pines),  
*Pandanus* spp. L.F., 23

Pangi,  
*Pangium edule* Reinw., 507

Pangnan  
*Lithocarpus bennettii* (Mig.)  
 Rehd.

Paper mulberry,  
*Broussonetia papyrifera* (L.)  
 Vent., 263, 425

Para rubber  
*Hevea brasiliensis* (HBK.)  
 Muell.-Arg., 44, 50, 70, 104,  
 515, 517, 533

Philippine mahogany (dipterocarps)  
 Dipterocarpaceae, 18, 19, 20,  
 54, 81, 94, 111, 133, 135,  
 191, 232, 259, 287

Pili,  
*Canarium ovatum* Engl., 71,  
 507, 511, 515, 520

Pili family,  
 Burseraceae, 71

Pines,  
*Pinus* spp., 84, 193, 324,  
 498, 503, 505, 509, 514, 526

Pingka-Pingkahan  
*Oroxylum indicum* (Linn.)  
 Vent., 185

Pitogo,  
*Cycas rumphii* Mig., C.  
*circinalis*, 76

Poinsettia,  
*Euphorbia pulcherrima* Willd.  
 76, 263

Pomelo,  
*Citrus maxima* (Burm.) Merr., 514

Pototan,  
*Bruguiera sexangula* (Lour.)  
 Poir.

Powder puff shrub,  
*Calliandra haematocephala*  
 Rush, 76

Pugahan,  
*Caryota cumingii* Lodd., 76

Purple Bauhinia,  
*Bauhinia purpurea* L., 532

Quinine,  
*Cinchona* spp., Linn., 29  
 70, 516

Raintree (Acacia),  
*Samanea saman* (Jacq.) Merr.,  
 60, 67, 179, 507, 510, 513,  
 533

Randia,  
*Randia macrantha* DC., 177,  
 181

Red Lauan  
*Shorea negrosensis* Foxw.,  
 18, 19

Red palm,  
*Cyrtostachya lakka* Becc.,  
 Rhodes Grass,  
*Chloris gayana* Kunth., 416

Rimas,  
*Artocarpus communis* J.R. &  
 G. Forst.

Royal palm,  
*Roystonea elata* (Bart.)  
 Harper, 76

Runo,  
*Miscanthus sinensis* Anders.,  
 294, 295, 484

Sampaguita,  
*Jasminum sampac* (L.) Ait., 76

Sampalok (Tamarind)  
*Tamarindus indica* L., 179,  
 488, 507, 533

Santol,  
*Sandoricum koetjape* Merr.,  
 488, 505, 507

Santol family  
 Meliaceae, 62, 187

Saraca,  
*Saraca declinata* Mig.

Scarlet plume,  
*Euphorbia fulgens* Karw., 263

Screw pines (Pandans)  
*Pandanus* spp. L.F., 23

Siamese Acacia (Kassod tree)  
*Cassia siamea* Lam., 68, 75,  
 111, 113, 178, 185, 488,  
 513, 515, 520, 532

Siar,  
*Peltophorum pterocarpum*  
 (DC.) Back.

Silky oak,  
*Grevillea robusta* A.Cunn., 76

Silverdollar,  
*Eucalyptus cinerea*, 76

Slash pine (Honduras pine)  
*Pinus caribea* Morelet, var.  
*hondurensis* Loock, 50, 58, 179

Soybean,  
*Glycine max* (Linn.) Merr., 337

Spanish cedar  
*Cedrela odorata* L.

Star apple (Caimito),  
*Chrysophyllum cainito* Linn.,  
 488

Sugarcane (Tuba),  
*Saccharum officinarum* L., 126

Sun hemp,  
*Crotolaria juncea* L.

Supa  
*Sindora supa* Merr., 21, 515,  
 520, 522, 533

Swamp mahogany  
*Eucalyptus robusta* Sm., 50,  
 56, 121, 533

Taiwan Red Cypress  
*Chamaecyparis formosensis*  
 Matsum. 50, 265

Talahib,  
*Saccharum spontaneum* L.,  
 subsp. *indicum* Hack., 85,  
 118, 142

Talisai,  
*Terminalia catappa* L., 23, 50,  
 120, 505, 507, 520

Taluto,  
*Pterocymbium tinctorium*  
 (Blanco) Merr.

Tamarind (Sampalok),  
*Tamarindus indica* L., 179,  
 488, 507, 533

Tambulian,  
*Busideroxylon zwageri* 523

Tanghas,  
*Myristica elliptica* Wall.

Tanglin,  
*Adenanthera intermedia* Merr.,  
 507

Tanguile  
*Shorea polysperma* (Blanco)  
 Merr., 18, 19, 21, 23

Tapilan (Anipai),  
*Phaseolus calcaratus* Roxb.,  
 337

Teak,  
*Tectona grandis* L., 44, 45,  
 50, 62, 65, 73, 81, 84, 97,  
 110, 111, 113, 123, 138, 142,  
 156, 157, 181, 185, 186, 187,  
 190, 232, 239, 250, 254, 257,  
 258, 269, 287, 289, 313, 488,  
 498, 499, 505, 507, 509, 513,  
 515, 520, 521-523, 525, 528,  
 533

Tiaong,  
*Shorea agsaboensis*, 19

Tibig,  
*Ficus nota* (Blanco) Merr.,  
 185, 425, 467

Tikal,  
*Livistona* spp. Linn., 76

Tindalo,  
*Azelia rhomboidea* Vid., syn.  
*Pandua rhomboidea* (Blanco)  
 Prain, 21, 257, 507, 520,  
 522, 533



- Tiwi,  
Dolichandrone spathacea (L.f.)  
K. Schum., 185
- Toog,  
Combretodendron quadrialatum,  
66
- Trumpet tree,  
Datura alba Nees, 426
- Tuai,  
Bischofia javanica Blume, 532
- Tuba (Sugarcane)  
Saccharum officinarum L., 126
- Tukang-kalau,  
Aglaiia clarkii Merr.
- Tung oil tree,  
Aleurites fordii Hemsley, 53
- Uoko,  
Mikania scandens, 146
- Upland rice  
Oryza sativa L., 127
- Urung  
Fagraea fragrans Roxb., 533
- Vidal's lanutan,  
Bombycidendron vidalianum (Naves)  
Merr. & Rolfe, 532
- Weeping love grass,  
Eragrostis curvula, 427
- White lauan,  
Pentacme contorta (Vid.)  
Merr. & Rolfe, 18, 19, 20,  
111, 112, 133, 533
- White nato,  
Pouteria macrantha (Merr.)  
Baehni
- Willows,  
Salix spp. Linn., 425, 478
- Yakal,  
Shorea gisok Foxw., 18, 19,  
20
- Yellow bell,  
Solandra hartwegii No. E.  
Brown, 76
- Yemane (Melina),  
Gmelina arborea (Linn.)  
Roxb., 44, 50, 57, 65, 66,  
73, 84, 97, 110, 111, 127,  
160, 185, 232, 250, 254,  
257, 258, 263, 313, 488,  
505, 507, 513, 515, 533
- Acacia auriculiformis A. Cunn.,  
178, 515, 532
- Acacia catechu (L.F.) Willd.,  
Cutchtree, 515, 520, 532
- Acacia farnesiana (L.) Willd.,  
Aroma, 50, 51, 120, 238, 488,  
515, 520, 532
- Actinophloeus macarthurii (H.Wendl.)  
Becc.,  
MacArthur palm, 76
- Adenantha intermedia Merr.,  
Tanglin, 507
- Afzelia rhomboidea Vid., (syn.  
Pahudia rhomboidea (Blanco)  
Prain),  
Tindalo, 21, 257, 507, 520,  
522, 533
- Agathis loranthifolia, 112
- Agathis philippinensis Warb.  
(syn. A. alba (Lam.) Foxw.)  
Almaciga, 51, 71, 111, 513,  
516-518, 532
- Agave cantala Roxb.,  
Maguey, 426
- Aglaiia clarkii Merr.,  
Tukang-kalau,
- Albizzia acle (Blanco) Merr.,  
Akle, 257, 515, 520, 522, 532
- Albizzia falcataria (L.) Back.,  
Moluccan sau, 50, 52, 61, 65,  
66, 81, 84, 93, 97, 124, 178,  
185, 232, 250, 507, 509, 513,  
532
- Albizzia lebbek (L.) Benth.,  
Lañgil, 515, 520, 532
- Albizzia julibrissin Durazz.,  
185, 532
- Albizzia lebbekoides (DC.) Benth.,  
Kariskis, 52
- Albizzia procera (Roxb.) Benth.,  
Akleng-parang, 50, 52, 111, 113,  
178, 185, 488, 513, 514, 532,
- Aleurites fordii, Hemsley,  
Tung oil tree, 53
- Aleurites moluccana (L.) Willd.,  
Lumbang, 50, 52, 71, 113, 124,  
178, 254, 257, 507, 511, 515,  
520, 522, 523, 524, 528, 532
- Aleurites trisperma Blanco,  
Baqilumbang, 52, 113, 507, 511,  
515, 520, 522, 532
- Alleanthus luzonicus (Blanco),  
F.-Vill.  
Himbabao,
- Alnus maritima Nuttall,  
Japanese alder, 44, 50, 53, 72,  
81, 97, 104, 256, 289, 322,  
425, 507, 509, 513, 515, 517,  
532
- Alstonia scholaris (L.) R. Br.,  
Dita, 111, 185, 507
- Anacardium occidentale L.,  
Casoi (Cashew), 44, 50, 113,  
178, 193, 373, 488, 532
- Anisoptera thurifera (Blanco)  
Blume,  
Palosapis, 18, 19
- Anthocephalus chinensis (Lamk.)  
Mig.,  
Kaatoan bangkal, 44, 50, 53,  
66, 84, 93, 97, 232, 250, 256,  
257, 287, 362, 364, 503, 507,  
511, 513, 516, 517, 532
- Araucariaceae, 71
- Araucaria bidwillii Hook,  
Bunya pine
- Araucaria excelsa (Lamb.) R.Br.,  
Norfolk pine, 75, 76
- Areca catechu Linn.,  
Betelnut palm, 76
- Arenga pinnata (Wurmb.) Merr.,  
Kaong
- Artocarpus blancoi (Elm.) Merr.,  
Antipolo, 488
- Artocarpus cumingiana Tréc.,  
Anubing
- Artocarpus communis J.R. & G. Forst.,  
Rimas
- Artocarpus heterophylla Lam.,  
Jackfruit (Nangka), 193, 505,  
514
- Avicennia officinalis Linn.,  
Api-api, 22
- Balanocarpus cagayanensis Foxw.,  
Narek
- Bambusa spinosa, Roxb.,  
Kawayan, 69, 426, 488
- Bambuseae,  
Bamboos, 72, 238

Bambusa vulgaris Schrad.,  
Kawayan-kiling, 69, 426, 488  
Barringtonia asiatica (L.) Kurz,  
Boton,  
Bauhinia acuminata L.,  
Bambang, 532  
Bauhinia malabarica Roxb.,  
Alibangbang, 50, 53, 75,  
185, 193  
Bauhinia monandra Kurz.,  
Fringon, 185, 532  
Bauhinia purpurea L.,  
Purple Bauhinia, 532  
Bischofia javanica Blume,  
Tuai, 532  
Bombycidendron campylosiphon Warb.,  
Lanutan  
Bombycidendron vidalianum (Naves),  
Merr. & Rolfe  
Vidal's Lanutan, 532  
Bougainvillea spectabilis Willd.,  
Bougainvillea, 76, 240, 263  
Broussonetia papyrifera (L.) Vent.,  
Paper mulberry, 263, 425  
Bruguiera sexangula (Lour.) Poir.  
Pototan,  
Burseraceae,  
Pili family

Calliandra haematocephala Rush.,  
Powder puff shrub, 76  
Callistemon lanceolatus DC.,  
Bottlebrush, 75, 76, 256, 362,  
507, 517, 532  
Calophyllum blancoi Bl. & Fr.,  
Bitanghol (Palomaria de Monte),  
Calophyllum inophyllum L.,  
Bitaog, 23, 50, 53, 120, 505,  
507, 515, 520, 523, 532  
Cananga odorata (Lam) Hook. f. & Th.,  
Ilang-ilang  
Canarium ovatum Engl.,  
Pili, 71, 507, 511, 515, 520  
Caryota cumingii Lodd.,  
Pugahan, 76  
Cassia fistula L.,  
Golden shower (Cafia fistula),  
44, 75, 111, 160, 185, 488,  
510, 513, 514, 515, 520, 532  
Cassia javanica L.,  
Antsoan, 75, 178, 185, 488, 507,  
510, 513, 515, 520, 532,  
Cassia multijuga Reichb.,  
Malakaturai, 75, 185, 488, 513,  
515, 520  
Cassia siamea Lam.,  
Kassod tree (Siamese Acacia),  
68, 75, 111, 113, 178, 185,  
488, 513, 515, 520, 532  
Cassia spectabilis L.,  
Antsoan-dilau, 75, 185, 488,  
513, 515, 520, 532  
Casuarina equisetifolia Forst.,  
Agoho, 23, 50, 53, 54, 74, 76,  
120, 178, 232, 250, 256, 269,  
287, 289, 362, 488, 507, 509,  
513, 515, 517, 532  
Casuarina glauca Sieber ex Mig.,  
50, 121  
Casuarina montana Leschen. ex  
Mig., 53, 54, 532  
Casuarina rumphiana Mig.,  
Agoho del Monte, 53, 54  
Cedrela odorata L.,  
Spanish cedar  
Ceiba pentandra (L.) Gaertn.,  
Kapok, 532  
Centrosema pubescens Benth.,  
Centrosema, 416, 426, 467  
Cestrum spp., Linn., 263  
Chamaecyparis formosensis Matsum.,  
Taiwan Red Cypress, 50, 265  
Chloris gayana Kunth.  
Rhodes Grass, 416  
Chrysalidocarpus lutescens H. Wendl.,  
Palmera  
Chrysanthemum cinerariaefolium, 340  
Chrysophyllum caimito Linn.,  
Star apple (Caimito), 488  
Cinchona spp. Linn.,  
Quinine, 29, 70, 516  
Citrus maxima (Burm.) Merr.,  
Pomelo, 514  
Cleistocalyx operculatus Merr.,  
& Perry,  
Malaruhah,  
Cocos nucifera Linn.,  
Coconut palm, 76  
Colocasia esculenta,  
Gabi (Taro), 128  
Combretodendron quadrialatum,  
Toog, 66  
Cordyline terminalis Kunth.,  
Baston de San Jose, 76, 263  
Corypha elata Roxb.,  
Buri palm, 71, 76  
Crotolaria juncea L.,  
Sun hemp  
Crotolaria spp., Linn., 337, 416  
Cryptomeria japonica (L.F.) D. Don.,  
Japanese cypress,  
50, 54, 75, 256, 263, 265,  
289, 532

Cunninghamia konishii Hayata,  
China-fir, 50  
Cupressus fragrans, 75, 76,  
256, 265  
Cupressus lusitanica Mill.,  
Mexican Cypress, 75, 76, 256,  
265  
Cycas revoluta Thunb.,  
Oliva  
Cycas rumphii Mig., C. circinalis,  
Pitogo, 76  
Cynodon dactylon (L.) Pers.,  
Bermuda Grass, 427  
Cynometra ramiflora L.,  
Balitbitan  
Cyrtostachya lakka Becc.,  
Red palm

Dacrydium spp., 24  
Datura alba Nees  
Trumpet tree, 426  
Delonix regia (Boj.) Raf.,  
Firetree, 75, 178, 505, 507,  
510, 515, 532  
Dendrocalamus strictus Nees, 177  
Dillenia philippinensis Rolfe,  
Katmon, 507  
Diospyros philippinensis (Desr.)  
Gurke  
Diospyros discolor Willd.,  
Mabolo, (Camagong, Kamagong),  
21, 488, 505, 507, 511, 514, 533  
Diospyros pyrrocarpa Mig.,  
Anang  
Dipterocarpaceae,  
Philippine mahogany (diptero-  
carps), 18, 19, 20, 54, 81, 94,  
111, 133, 135, 191, 232, 259,  
287  
Dipterocarpus warburgii Brandis,  
Hagakhak, 19, 20, 21  
Dipterocarpus grandiflorus Blanco,  
Apitong, 18-20, 133  
Dolichandrone spathacea (L.f.) K.  
Schum.,  
Tiwi, 185  
Dolichos lablab Linn.,  
Batau (Hyacinth bean), 416  
Dracontomelon dao (Blanco) Merr.  
& Rolfe,  
Dao, 511, 533  
Dracontomelon edule (Blanco)  
Skeels,  
Lamio

Duabanga moluccana,  
Loktub, 66  
Durio zibethinus Murr.,  
Durian

Endospermum peltatum Merr.,  
Gubas, 55, 66, 287, 533  
Eragrostis curvula,  
Weeping love grass, 427  
Erythrina variegata Linn.,  
var. orientalis (L.) Merr.,  
Dapdap, 75, 507  
Erythrophloeum densiflorum Merr.,  
Kamatog  
Eucalyptus camaldulensis Dehn.,  
50, 55, 74, 139, 533  
Eucalyptus cinerea,  
Silverdollar, 76  
Eucalyptus citriodora Hook,  
50, 56, 178  
Eucalyptus deglupta Blume,  
Bagras, 44, 50, 56, 65, 66,  
93, 533  
Eucalyptus grandis (Hill) Maiden  
50, 57, 533  
Eucalyptus robusta Sm.,  
Swamp mahogany, 50, 56, 121, 533  
Eucalyptus saligna Sm., 50, 56, 533  
Eucalyptus spp., Benth. and Muell.  
Eucalypts (Gum trees), 44, 50,  
74, 84, 97, 142, 232, 233, 250,  
256, 269, 287, 289, 362, 498,  
505, 507, 509, 513, 515, 517,  
526, 528  
Eucalyptus tereticornis Sm.,  
Eugenia javanica Lam.,  
Macopa, 24, 185  
Eusideroxylon zwageri,  
Tambulian, 523  
Euphorbia fulgens Karw.,  
Scarlet plume, 263  
Euphorbia pulcherrima Willd.,  
Poinsettia, 76, 263  
Euphorbia didyma Blanco,  
Alupag

Fagraea fragrans Roxb., 533  
Urung, 533  
Ficus nota (Blanco) Merr.,  
Ting, 185, 425, 467  
Ficus spp. Linn.,  
Balete, 76, 185

Gardenia jasminoides Ellis,  
Gardenia, 76  
Gliricidia sepium (Jacq.) Steud.,  
Madre de Cacao (Kakauati),  
44, 50, 57, 68, 72, 74, 233,  
240, 263, 425, 447, 478, 488,  
533  
Glycine max (Linn.) Merr.,  
Soybean, 337  
Gmelina arborea (Linn.) Roxb.,  
Melina (Yemane), 44, 50, 57,  
65, 66, 73, 84, 97, 110, 111,  
127, 160, 185, 232, 250, 254,  
257, 258, 263, 313, 488, 505,  
507, 513, 515, 533  
Grevillea robusta A. Cunn.,  
Silky oak, 76  
Grewia spp. Linn., 185  
  
Helianthus tuberosus L.,  
Mexican sunflower, 72, 426,  
428, 447, 488  
Heritiera littoralis Dryand.,  
Duñgon-late, 23  
Hevea brasiliensis (HBK.) Muell.  
Arg.,  
Para rubber, 44, 50, 70, 104,  
515, 517, 533  
Hibiscus spp. Linn.,  
Gumamela, 76, 185, 263  
Homalium foetidum (Roxb.) Benth.  
Aranga  
Homonoia riparia Lour.,  
Dumanay, 426, 470  
Hopea acuminata Merr.,  
Manggachapui, 19  
Hopea foxworthyi Elm.,  
Dalingdingan, 19  
Hopea philippinensis Dyer,  
Gisok-gisok, 19  
Hymenaea courbaril L.,  
Jatoba  
  
Imperata cylindrica Beauv., J.  
exaltata Brongn.,  
Cogon, 85, 94, 118, 123, 142,  
144, 165, 197, 234, 279, 298,  
408, 409  
Intsia bijuga (Colebr.) O. Ktze.  
Ipil, 21, 257, 313, 507, 520,  
522, 526, 533  
Ipomoea batatas,  
Camote (sweet potatoes), 127

Jacaranda mimosaeifolia D. Don,  
Jacaranda, 75  
Jasminum sampac (L.) Ait.,  
Sampaguita, 76  
Juniperus spp.,  
Junipers, 265  
  
Kingiodendron alternifolium  
(Blm.) Merr. & Rolfe,  
Batete  
Koompassia excelsa Faub.,  
Manggis  
Koordersiodendron pinnatum  
(Blanco) Merr.,  
Amugis  
  
Lagerstroemia piriformis Koehne,  
Batitinan  
Lagerstroemia speciosa (L.) Pers.,  
Banaba, 50, 75, 111, 121, 185,  
256, 467, 488, 507, 509, 513,  
515, 526, 533  
Lantana camara Linn.,  
Lantana, 72, 76, 185, 240,  
263, 426, 488  
Leguminosae,  
Legumes, 68, 287, 322, 336, 337,  
416, 424, 505, 519, 521, 528  
Lespedeza cuneata G. Don,  
Lespedeza, perennial, 416, 426  
Leucaena leucocephala (Lam.) de  
Wit, syn. L. glauca,  
Ipil-ipil, 44, 50, 58, 67, 68,  
72, 74, 81, 84, 104, 113, 114,  
188, 198, 233, 240, 263, 416,  
425, 436, 447, 478, 488, 507,  
509, 513, 514, 515, 526, 533  
Leucaena leucocephala (Lam.) de Wit  
Giant ipil-ipil, 58, 68  
Lithocarpus bennettii (Mig.) Rehd.,  
Pangnan  
Livistona spp. Linn.,  
Tikal, 76  
Lupinus spp., Linn., 337  
  
Macadamia hildebrandii, 171  
Macaranga spp. Thouars, 185  
Madhuca betis (Blanco) Macbh. &  
Merr.,  
Betis

Mangifera indica L.,  
Mango, 58, 178, 185, 193,  
505, 513, 514  
Manilkara zapota (L.) Van Royen,  
Chico, 514  
Manihot utilisissima,  
Cassava, 126, 127, 128  
Martinezia caryotaefolia HBK.,  
Martinez's palm  
Melastomataceae,  
Melastoma family, 185  
Meliaceae,  
Santol family, 62, 187  
Merremia peltata,  
Bulacan, 146  
Michelia champaca L.,  
Champaka, 513, 533  
Mikania scandens,  
Uoko, 146  
Miscanthus sinensis Anders.,  
Runo, 294, 295, 484  
Moraceae,  
Mulberry family, 190  
Moringa oleifera Lam.,  
Malunggay, 240  
Morus spp. Tournef.,  
Mulberry spp., 84, 185, 263  
Mucuna nigricans (Lour.) Steud.,  
Lipai, 426  
Myristica elliptica Wall.,  
Tanghas  
Myristica philippensis Lam.,  
Duguan  
  
Nauclea junghuhnii (Mig.) Merr.,  
Bangkal, southern, 426  
Nauclea orientalis L.,  
Bangkal, 426  
Nerium indicum Mill.,  
Oleander, 263  
Nipa fruticans Wurmb.,  
Nipa palm, 22  
  
Ochroma pyramidale Cav. ex Lam.,  
syn. O. lagopus Sw.,  
Balsa, 507, 533  
Octomelis sumatrana Mig.,  
Binuang, 44, 66, 93, 513, 533  
Oroxylum indicum (Linn.) Vent.,  
Pingka-pingkahan, 185  
Oryza sativa L.,  
Upland rice, 127

Palaquium luzoniense (F.-Villd.)  
Vid.,  
Nato,  
Palaquium philippinensis (Perr.)  
C. B. Rob.,  
Malakmalak,  
Palmae,  
Palms, 76  
Pandanus spp. L.f.,  
Pandans (Screw pines), 23  
Pangium edule Reinw.,  
Pangi, 507  
Panicum maximum Jacq.,  
Guinea grass, 198  
Parashorea plicata Brandis,  
Bagtikan, 18, 19, 111, 112,  
133, 533  
Parkia javanica (Lam.) Merr.,  
Kupang, 510, 533  
Paspalum dilatatum Poir.,  
Dallis Grass, 416  
Peltophorum pterocarpum (DC.)  
Back.,  
Siar  
Pennisetum clandestinum Hochst.,  
Kikuyu grass, 416, 427  
Pennisetum purpureum Schum.,  
Elephant grass, 198  
Pentacme contorta (Vid.) Merr.  
& Rolfe,  
White lauan, 18, 19, 20, 111,  
112, 133, 533  
Phaseolus aureus Roxb.,  
Mungo bean, 337  
Phaseolus calcaratus Roxb.,  
Tapilan (Anipai), 337  
Pinus caribea Morelet, var.  
hondurensis Loock,  
Slash pine (Honduras pine),  
50, 58, 179  
Pinus insularis Endl., syn. P.  
khasya Royle, 23, 24, 44, 50,  
58, 59, 65, 66, 81, 97, 104,  
149, 179, 182, 183, 188, 189,  
197, 232, 250, 256, 257, 260,  
260, 269, 287, 362, 374, 425,  
503, 507, 508, 510, 513, 515,  
517, 528, 530, 531, 533  
Pinus merkusii Jungh. & De Vr.,  
Mindoro pine, 23, 59, 97, 162,  
171, 321, 503, 504, 507, 510,  
513, 516, 517, 533  
Pinus oocarpa, 58, 59  
Pinus radiata D. Don, 162  
Pinus spp.,  
Pines, 84, 193, 324, 498, 503,  
505, 509, 514, 526

*Pithecolobium dulce* (Roxb.) Benth.,  
 Kamachile, 50, 59, 238, 239,  
 426, 488, 507, 509, 533  
*Plumeria acuminata* Ait.,  
 Kalachuchi, 75, 263  
*Podocarpus blumei* Endl.,  
 Malaalmaciga, 75, 513  
*Podocarpus imbricatus*, syn. *P.*  
*javanicus*,  
 Igem, 75  
*Podocarpus* spp., 24  
*Polyscias nodosa* (Blume) Seem.,  
 Malapapaya, 507  
*Pometia pinnata* Forst.,  
 Malugai  
*Pouteria macrantha* (Merr.) Baehni,  
 White nato  
*Premna* spp. Linn., 185  
*Psidium guajava* L.,  
 Guava, 44, 50, 60, 426, 514  
*Pterocarpus indicus* Willd.,  
 Narra, smooth, 60, 65, 153,  
 179, 533  
*Pterocarpus vidalianus* Rolfe,  
 Narra, prickly, 60, 65  
*Pterocarpus* spp.,  
 Narra, 21, 44, 45, 50, 60, 73,  
 83, 84, 97, 104, 232, 250, 254,  
 257, 269, 289, 313, 488, 504,  
 505, 507, 509, 513, 515  
*Pterocymbium tinctorium* (Blanco)  
 Merr.,  
 Taluto,  
*Pueraria phaseoloides* (Roxb.)  
 Benth.,  
 Kudzu, 337, 416, 426, 467  
*Pueraria thunbergiana* Benth.,  
 syn. *P. hirsuta* Schneider,  
 Kudzu, 426, 467  
  
*Quercus* spp.,  
 Oaks, 24  
  
*Randia macrantha* DC.,  
 Randia, 177, 181  
*Rhizophora candelaria* DC.,  
*Rhizophora mucronata* Lam.,  
 Bakauan, 22  
*Roystonea elata* (Bart.) Harper  
 Royal palm, 76  
  
*Saccharum officinarum* L.,  
 Tuba (Sugarcane), 126  
  
*Saccharum spontaneum* L. subsp.  
*indicum* Hack.,  
 Talahib, 85, 118, 142  
*Salix* spp. Linn.,  
 Willows, 425, 478  
*Samanea saman* (Jacq.) Merr.,  
 Acacia (Raintree), 60, 67,  
 179, 507, 510, 513, 533  
*Sandoricum koetjape* Merr.,  
 Santol, 488, 505, 507  
 Sapotaceae,  
 Chico family, 190  
 Saraca  
*Saraca declinata* Mig.,  
*Schizostachyum diffusum* (Blanco)  
 Merr.,  
 Bikal, 146  
*Schizostachyum lumampao* (Blanco)  
 Merr., 70, 275, 426, 488  
*Sesbania grandiflora* (Linn.) Pers.,  
 Katurai, 61, 67, 198, 240  
*Shorea agsaboensis*,  
 Tiaong, 19  
*Shorea almon* Foxw.,  
 Almon, 18, 19  
*Shorea astylosa* Foxw.,  
 Gisok, 19  
*Shorea gisok* Foxw.,  
 Yakal, 18-20  
*Shorea negrosensis* Foxw.,  
 Red Lauan, 18, 19  
*Shorea philippinensis* Brandis,  
 Manggasinoro, 18, 19  
*Shorea polita* Vid.,  
 Malaanonang, 19  
*Shorea polysperma* (Blanco) Merr.,  
 Tanguile, 18, 19, 21, 23  
*Shorea squamata* Dyer,  
 Mayapis, 18, 19, 111, 133  
*Sindora supa* Merr.,  
 Supa, 21, 515, 520, 522, 533  
*Solandra hartwegii* N.E. Brown,  
 Yellow bell, 76  
*Solanum* spp., Linn., 185  
*Spathodea campanulata* Beauv.,  
 African tulip, 66, 75, 256,  
 263, 313, 507, 533  
*Sterculia foetida* L.,  
 Kalumpang, 507  
*Swietenia macrophylla* King,  
 Mahogany; large leaf, 44, 50,  
 61, 65, 533  
*Swietenia mahogany* Jacq.,  
 Mahogany; small leaf; 50, 61  
*Swietenia* spp.,  
 Mahogany, 81, 84, 94, 97, 104,  
 133, 135, 187, 188, 232, 250,  
 254, 257, 259, 269, 289, 303, 313,  
 505, 507, 509, 513, 515, 530.

*Zyzygium cumini* (L.) Skeels,  
 Duhat, 511

*Tamarindus indica* L.,  
 Tamarind (Sampalok),  
 179, 488, 507, 533  
*Tarrietia javanica* Blume,  
 Lumbayao,  
*Tarrietia sylvatica* Merr.,  
 Dufigon,  
*Tectona grandis* L.,  
 Teak, 44, 45, 50, 62, 65, 73,  
 81, 84, 97, 110, 111, 113,  
 123, 138, 142, 156, 157, 181,  
 185, 186, 187, 190, 232, 239,  
 250, 254, 257, 258, 269, 287,  
 289, 313, 488, 498, 499, 505,  
 507, 509, 513, 515  
*Terminalia catappa* L.,  
 Talisai, 23, 50, 120, 505,  
 507, 520  
*Terminalia edulis* Blanco,  
 Kalumpit, 507  
*Terminalia superba*,  
 Limba  
*Thuja orientalis* L.,  
 Arbor vitae, 76, 265  
*Toona calantas* Merr. Rolfe,  
 Kalantas, 21, 44, 45, 50, 62,  
 104, 193, 256, 507, 509, 513,  
 515, 533  
*Trema orientalis* Blume,  
 Anabiong  
*Triplaris cumingiana* Fisch. & Mey.,  
 Palosanto

*Vatica manggachapui* Blanco,  
 Narig, 19  
*Vigna sinensis* (Linn.) Savi,  
 Cowpea  
*Vitex parviflora* Juss.,  
 Molave, 21, 44, 45, 50, 63,  
 104, 185, 232, 239, 287,  
 488, 505, 507, 511, 533,

*Wallaceodendron celebicum* Koord.,  
 Banuyo, 21  
*Wrightia laniti* (Blanco) Merr.,  
 Lanete, 507

*Xylopia ferruginea* Baill.,  
 Banlag,

*Zea mays* L.,  
 Corn (Maize), 126, 127

P A R T V I I I

S U B J E C T I N D E X

Acaricides, 340, 344, 378, 379  
 Actinomycetes, 321, 324  
 Active ingredient, pesticides,  
 344, 345, 355  
 Agallol, 256, 348, 356, 377, 384  
 Agglomerates, 8, 10  
 Aldrin, 347, 348, 356, 368, 369,  
 370, 371, 373, 379, 380  
 Alluvial deposits, 8, 9  
 Aluminium hydroxide, 10  
 Alpha-naphtalene-acetic acid,  
 266  
 Ammonium, 328, 329, 330, 331  
 - , nitrate 324, 328, 329  
 - , sulfate 324, 328, 329,  
 332, 334  
 Analysis, nutrient elements on  
 fertilizer bag, 138, 328, 330  
 - , soil, 46-49, 327  
 Andesite, 8, 10  
 Anthraquinone, 347, 374, 384  
 Ants, 192, 356, 370, 380  
 Aphids, 339, 340, 367, 370, 382  
 Aphyxiation (Oxygen deficiency of  
 roots), 343  
 Apron, erosion control, 463, 464,  
 466, 468, 485  
 Arboricides, 131, 134, 146, 147  
 Armillaria mellea, 178, 181  
 Armyworms, 368  
 Asexual propagation, 262-267, 501,  
 502  
  
 Bacillus thuringiensis, 341, 383  
 Backfire, 175  
 Bacteria, 289, 319, 321, 322, 324,  
 329, 361, 363, 376  
 Bacterioses, 341  
 Baiting stations for rodent  
 control, 194, 374  
  
 Balled plants, 103, 111, 112,  
314, 315  
 Bamboo plantations, 69, 70  
 - rust (Dasturella divina),  
 180  
 Bank erosion, 398, 399, 402,  
473 - 486, 487  
 Bank stabilization, rivers,  
 streams, lakes, 419, 425, 426,  
 449, 453, 473 - 486  
 Bar chart, 90  
 Bare root seedlings, 98, 104,  
 118, 235, 269, 309 - 313  
 Basal area, 160, 161, 162  
 Basalt, 7, 8, 10  
 Bases, leaching of, 10, 11  
 Basic slag, 324, 329, 332  
 Basudin, 339, 341, 367, 368,  
 380, 381  
 Baygon, 356, 368, 370, 371, 372,  
382  
 Bayrusil, 340, 341, 367, 380,  
381  
 Beach forest, 18, 19, 22  
 Beautification, 75 - 77, 86,  
 453, 487  
 Beauveria bassiana, 191  
 Bed load, 399, 403, 473, 479  
 Bedrock, 395  
 Beetles, 181, 182, 190, 191,  
 192, 339, 367, 371, 379  
 Bench brush layers, 441 - 446,  
 470  
 Binlid, 194  
 Birds, 114, 115, 192, 346, 374,  
 384  
 - , repellents, 344, 347, 384  
 Bitumen emulsion, 428, 429, 445,  
453-454  
 Blight, 178, 179, 363  
 Blotch, 363  
 Boho pots, 69, 100, 103, 275, 281

- Borers, insects, 368, 379, 382  
 Boron, 138, 266, 324, 325, 332  
 Botrytis, 178, 361, 363  
 Braconidae, 191, 192  
 Branchiness, 66, 83, 148, 149, 154, 155, 157, 187 - 189, 500  
 Brand names of pesticides, 344, 376 - 384  
 Brassicol, 347, 348, 356, 362, 377  
 Broadcast sowing, 113, 256, 257, 260  
 Browsing trails, 197, 409, 414  
 Brush combs, erosion control, 471  
 Brush covers, 436 - 441, 463, 479, 481, 482  
 Brush layers, 441-446, 470  
 Buffering of soils, 325, 331  
 Bugs, 367, 370  
 Buildings, project nursery, 240, 241  
 Buntal fiber, 71  
 Burning of pastures, 165, 197, 198  
 Burning permits, 169, 198, 415  
 Butterflies, 367
- Calcium, 137, 316, 324, 325, 326, 331, 332, 405  
 - , carbonate, 11, 331, 334  
 - , nitrate, 324, 328, 329, 332, 334  
 Calculation with forest tree seed, 530-533  
 Canals, drainage, 431, 462, 463, 470, 483  
 - , irrigation, 236, 243, 247, 248, 252-254, 284, 298  
 Captan, 266, 339, 347, 348, 357, 362, 363, 377  
 Carbamates, 339, 382, 383  
 Care and maintenance of seedlings, 283 - 306  
 Carrying capacity of flow, 399, 402, 403, 479, 480  
 Catchment area, 73, 401-403, 462, 463, 473  
 Caterpillars, 181-188, 339, 367, 368, 383  
 Cattle ranching, 196-198, 408, 408, 409, 414-416  
 Cement, 238, 240, 419, 420, 456, 457
- Cement mixing machine, 280, 346  
 Cerambycid beetle, 191  
 Ceresan, 342, 346, 348, 377, 384  
 Checkdams, 243, 245, 420 - 423, 465-469, 470, 471  
 Chelates, 332  
 Chlordane, 348, 368-372, 379  
 Chlorinated hydrocarbons, pest control, 339, 357, 365, 369, 379, 380  
 Chlorine, 325, 332  
 Chloropicrin, 347, 357, 377  
 Chlorosis, 10, 343, 326, 331, 332, 365  
 Chlorox, 346  
 Choice of tree species for reforestation, 43-77  
 Circular spades, 103, 111, 314  
 Clays, 9, 235, 279, 317, 318, 329, 403-405, 418  
 Clear - cutting, 27, 417  
 Clearing of patches and strips for planting, 93-95, 131  
 Climate map of the Philippines, 16  
 Climatic conditions, 12-17, 43, 90, 160, 250, 338, 400  
 Climatic types, 14, 45, 250  
 Climber cutting, 93, 134, 145  
 Climbing trees for seed collection, 506 - 508  
 Clones, 502  
 Close traverse, surveying, 222 - 227  
 Cobalt, 325  
 Cochroaches, 342, 371, 372, 380  
 Coconut beetle (*Oryctes rhinoceros*), 191  
 Combined structures, erosion control, 456 - 472  
 Commercial fertilizers, 328-333  
 Commercial plantations, 70, 150  
 Compass surveying, 207-228  
 Complete fertilizer, 120, 133, 135, 137, 180, 267, 280, 327, 330, 331, 337, 411, 417, 439, 442, 447, 451, 453, 454  
 Compost, 241, 255, 278, 280, 289, 331, 333-336, 362  
 Concessions, long term, 150  
 Concrete, 419, 420, 456, 457, 464, 467, 485  
 Conduits, 431  
 Cone picker, 506  
 Conifer plantations, 149, 150, 151, 158, 167, 178  
 Containers, potting, 273-277
- Containers, preparation of pesti-  
 cidal liquid, 353, 386  
 - , seed collection, 507  
 - , seed storage and seed shipment, 514-518  
 Contour trenches, 120, 433, 434, 436, 463  
 Conversion factors, 385, 386  
 Convection column, 13, 166, 169  
 Copal, 51, 71  
 Copper, 138, 324, 325, 332  
 - , fungicides, 363  
 Coppice system, 68, 74  
 Cordons (French), erosion control, 441-446, 470  
 Corner points, surveying, 216, 220, 222  
 Coumarine baits, 194, 373, 384  
 Counterfire, 175  
 Crop species, 124, 126, 127, 408, 411, 487  
 Cross-pollination, 501, 502  
 Culling of nursery plants, 96, 307 - 309  
 Cultivation, nursery beds, 257, 273, 284, 299, 300, 301  
 Culverts, 418, 431, 433, 453  
 Curbing of nursery beds, 253, 282, 298  
 Cuttings, 72, 127, 128, 262-267, 424-426, 427, 428, 440, 441, 445, 447, 452, 458-460, 464, 468-470, 479  
 Cutting cycle, 68  
 - , test, 505, 526  
 Cutworms, 367, 368, 369  
 Cyclones, tropical, 14-17, 73, 171, 233, 418, 441, 463
- Damping - off, 177, 256, 260, 262, 342, 347, 348, 356, 361-362, 376, 377, 378  
 Dasturella divina, (see bamboo rust)  
 DDT, 339, 340, 344, 357, 366, 379  
 Decomposition of organic material, 289, 290, 319, 320, 334, 336  
 Deficiency symptoms on plants, 325-327, 342, 365  
 Defoliators, 181, 183-185, 190, 367, 368  
 Dessicators for seed storage, 514, 517  
 Diagnostic sampling, 130
- Diameter growth, 137, 139, 140, 161, 500  
 Diazinon, 366-369, 371, 372, 380, 381  
 Dieback, 187, 363, 365  
 Dieldrin, 347, 348, 368, - 371, 373, 379, 380  
 Dilution effect, 138  
 Dipterex, 339, 356, 368, 370, 381  
 Dipterocarp forests, 5, 18, 19, 25, 54, 65  
 - , wildlings, 112, 133  
 Direct seeding, 94, 113, 114, 115  
 Diseases, control of, 177, 179, 325, 326, 329, 338, 361-363, 376, 377  
 Disyston, 356, 366-368, 382  
 Dolomite, 331, 332  
 Dormancy in seed, 512, 520-524, 528  
 Dothistroma pini (Pine needle blight), 178, 179  
 Dowfume, 377, 378  
 Dowpon, 144
- Earthworms, 289, 319, 320  
 Ecological aspects and factors, choice of tree species, 43-45  
 Economic returns, 73, 162  
 Edaphic factors, choice of tree species, 46-50  
 Emulsifiable concentrate, 345, 353, 354, 356  
 Endosulfan, 357, 367, 368, 369, 379, 380  
 Endrin, 339, 357, 380, 381  
 Enrichment planting, 84, 94, 130-135, 141  
 Equivalent, 385, 386  
 Erosion, accelerated, 393, 411  
 - , effects of, 411-413  
 - , factors affecting 400 - 407  
 - , geological, 393, 411  
 - , gravity, 394, 395  
 - , gully, 394, 396-398, 409, 411, 418, 430, 431  
 - , man-made, 393, 407-410  
 - , raindrop, 395, 396, 406, 412  
 - , rill, 396, 397, 398, 409, 430  
 - , river banks, 398, 399, 402, 473-486, 487

Erosion, sheet, 396, 397  
- , splash, 395  
- , water, 395-399  
- , waterfall, 397, 463  
- , wind, 73, 394, 487-489  
- , control, 25, 72, 81,  
393-492  
Etiolation, 291, 307, 343  
Evaporation, 103, 119, 284, 288,  
301, 307, 412, 487  
Extension pruners, 506  
  
Fascines, 431, 433, 438, 449 -  
452, 481  
Fast growing species, 66, 67,  
83, 113, 124, 140, 500  
Faustmann formula, 163  
Feldspar, 137, 316  
Fencing, nursery site, 236,  
238 - 240  
- , pasture land, 414  
Fences, piles and poles for  
68, 69  
Ferbam, 266, 339, 347, 363, 376  
Fertilizer application, nursery,  
306, 324, 327, 329-332  
- , plantations  
136 - 140  
Fertilizers, 137, 240, 324,  
328 - 337  
Fiber glass, 241, 296  
Fiber, long for pulp, 66, 69  
Field capacity of soil, 403, 404  
Field notes, surveying, 209, 210,  
218-221, 222  
Field planting (see planting)  
Field sketches, surveying, 211-215,  
221, 222-224, 228  
Financial return, 162  
Fire, 23, 62, 71, 152, 157, 165-  
176, 182, 197, 408, 409, 414,  
415  
Fire breaks, 83, 170, 171, 174  
- control, 165-176, 234  
- lines, 91, 171, 174, 175, 198  
- swatter, 172, 173, 176  
First aid kit, 173, 176  
Flitgun, 349  
Flooding, 232, 236, 247, 248,  
254, 269, 284, 343, 365, 373  
Flumes, 248  
Fodder grass, 198, 409, 415, 416  
Fomes, 128, 177, 178  
Forage grasses, 198, 409, 415, 416  
Forests, management of natural,  
25 - 27

Forest plantations, 63-87  
- products, "minor", 51,  
70, 71  
- reserve, 196, 415, 417  
- types, 18 - 24, 62  
Formaldehyde, 342, 346, 377  
Frames, protective, over nursery  
beds, 253, 264, 267, 296, 339,  
373  
Fruit trees, 71, 263, 276, 487  
Fuelwood, 58, 67, 72, 74, 127,  
157, 407, 408  
Fungi, 153, 156, 177-180, 191,  
254, 265, 289, 319, 321, 324,  
347, 361-363  
Fungicides, 256, 266, 339, 342,  
344, 346, 347, 348, 362, 363,  
376 - 377  
Furrow-irrigation, 232, 236,  
247, 248, 253, 284

Gabions, 420-423, 458, 464,  
485, 486  
Gall insects, 368  
Ganoderma lucidum, 177, 178  
Garbage disposal, 335, 341  
Genetical quality of seed, 405,  
498 - 502  
Genotype, 263  
Geographical situation of the  
Philippines, 3-7  
Germination of seed, 512,  
520-524, 526-529  
Germination tests, 527-529, 530  
Germinative capacity, 113, 250,  
260, 497, 503-505, 512-520,  
527-531  
- energy, 525, 527-529,  
530  
Girdling of trees, 81, 94, 134,  
146, 148  
Gradient, conversion table of,  
490  
Grading of nursery plants, 307,  
308  
Grafting, 501,  
- wax, 265  
Granules, pesticides formulated  
as, 345, 356, 369  
Grasshoppers, 367, 368, 379, 380  
Grassland sites, 62, 94, 95, 101,  
109, 110, 114, 122, 123, 193,  
196-198, 235, 408, 414-416  
Grazing, 18, 157, 170, 196-198  
409, 414-416

Gravel, 317, 403, 411, 419, 420,  
423, 432  
Greenhouse, 241, 248, 251, 254-256,  
261, 296, 338, 341, 342, 347,  
348, 365, 369, 372  
Green manuring, 298, 336, 337  
Ground ties, erosion control, 465,  
469, 470, 486  
Growth hormones, 265, 266  
Groynes, 475, 476, 477, 484-486  
Grubs, 369  
Gully erosion, 394, 396-398, 409,  
411, 418, 430, 431  
Gully stabilization, 418, 421,  
425, 426, 429, 430, 445, 462-  
472

Handling of pesticides, 356-359  
Hapalia macheralis (see teak  
skeletonizer)  
Hardening-off, 305-306, 329, 362  
Heart rot (Fomes annosus), 128, 177  
Hedges, 85, 240, 298  
Heeling-in of bare root seedlings,  
312, 313  
Heptachlor, 347, 348, 356, 357,  
368-371, 379, 380  
Herbicides, 144, 301, 302, 343  
History of reforestation work in  
the Philippines, 28-32  
Hornblende, 316  
Hornworms, 368  
Hoplocerambyx spinicornis, 191  
Humidity, relative, 168, 178,  
179, 338, 342, 362, 363, 514  
Humus, 46, 136, 316, 319, 320,  
331, 333-337, 405, 406  
Hyblaea puera (see teak defo-  
liator)  
Hydrological cycle, 73  
Hydro-seeding, 427, 445, 455  
Hypsipyla robusta, (see Mahogany  
shoot borer)

Ichneumonoidae, 191, 192, 339-341  
Igneous rocks, 10  
Implement carriers, 301  
Increment, 139, 140, 152, 159,  
160, 163  
Index number, survey, 209, 217,  
218  
Indolebutyric acid, 266  
Industrial plantation, 32, 64-66,  
158-164

Infiltration capacity of soil,  
10, 11, 120, 289, 317-320,  
401, 403, 405, 406, 412,  
436, 462  
Insect calamities in plantations,  
natural control factors, 189-193  
Insecticides, 339-341, 345, 347,  
348, 357, 366-372, 379-383, 519  
Insects, 114, 115, 181-193, 339,  
346, 356, 366-372, 519  
Inventory, residual, 26  
Ips interstitialis (bark beetle),  
182, 183  
Iron, 10, 137, 138, 316, 324,  
325, 326, 332, 405  
Irrigation, nursery, 232, 236,  
242-249, 252-254, 269, 283-288,  
298, 306  
Isoptera (see termites)

Jassids, 366

Kaingin, 11, 18, 123-129, 130,  
165, 169, 402, 408, 416, 417,  
427  
Karathane, 363, 377, 379  
Kelthane, 356, 378

Land classification, 196, 207,  
222  
Landscaping, 75-77, 86, 453, 487  
Landslides, 394, 395, 404, 409,  
412, 413, 425, 427, 431  
Land-use, forms of, 196, 211,  
406, 411, 414, 415  
Lateritic soils, 10, 11, 405  
Latosols, 10  
Lauan forest, 19, 20  
Lauan-Apitong forest, 19, 20  
Lauan-Hagakhak forest, 19, 20,  
21, 62  
Lead, red, 114, 347, 374  
Leafhoppers, 366, 379, 382  
Leaf miners, 368, 379, 380, 382  
- rollers, 339, 368, 379  
- tiers, 368  
Leafworms, 367, 368  
Liberation cuttings, 158, 159  
Lifting of bare root seedlings,  
257, 268, 307, 309  
Light demanding species, 81,  
132, 142, 269



- Lime, fertilizer, 278, 330, 331, 332, 334, 362
- Limestone, 3, 6, 7, 8, 11, 21, 331, 332
- Lindane, 339, 347, 348, 368, 369, 373, 379
- Line brushing, 94  
- enrichment, 94, 130-135
- Liquid measures, pest control, 353, 386
- Litmus paper, 322, 323
- Live structures, erosion control, 429, 430, 435-455, 476 - 482
- Loam, 48, 234, 272, 280, 288, 318, 403, 404, 418, 445
- Loamy sands, 48, 235, 314, 317
- Locusts, 367, 368
- Logging, 18, 25-27, 68, 79, 180, 183, 407, 408, 417, 418, 462
- Longevity of seed, 250, 512, 513, Loopers, 368
- Low volume spraying, 349
- Lumbang oil, 71
- Maceration, seed extraction, 511
- Machinery, agricultural, in the nursery, 234, 237, 240, 241, 245, 251, 257, 301
- Magnesium, 137, 316, 324, 325, 326, 332, 405
- Mahogany shoot borer (*Hypsipyla robusta*)
- Malathion, 339, 340, 341, 366, 367-369, 372, 380, 381
- Maneb, 339, 344, 363, 376
- Manganese, 138, 324, 325, 326, 332, 360
- Mangrove forest, 18, 19, 22
- Manila copal, 51, 71
- Manila elemi, 71
- Mantids, 192
- Manure, 241, 298, 333, 334, 342, 417
- Map, climate of the Philippines, 16  
- , plantation, 41  
- , project, 42  
- , reforestation projects in the Philippines, 31
- Mapping, 207 - 228
- Marcotting, 262
- Marine sediments, 5
- Marking of trees, liberation cuttings, 160
- Marking of trees, selective logging, 25
- Masonry, 419, 420, 456, 457, 464, 485
- Matting, erosion control, 436-441, 481, 482
- Mattresses, erosion control, 439-441, 481, 482
- Measures, weight, length, area, volume, conversion factors, 385, 386
- Measuring containers, 242, 259, 353, 386  
- stick, layout of nursery beds, 252
- Mechanization of nursery work, 237, 257, 301
- Mercury compounds, 339, 342, 346, 348, 356, 377
- Merthiolate, 342, 346
- Mesh wire cylinder, erosion control, 482, 485, 486
- Mesozoic period in the Philippines, 4, 5, 6
- Metaldehyde, 373, 383
- Metarrhizum anisopliae (*Muscardine fungus*)
- Metasystox, 339, 340, 357, 366, 367, 368, 382
- Methylbromide, 347, 357, 377, 519
- Mice, 114, 115, 193-195, 346, 373, 374, 518, 519
- Micro-nutrients (see trace elements)
- Mildew, 178, 345, 362, 363, 376, 378, 379
- Mineral soil particles, 316, 317
- Minium, 347, 374
- Misting system in the greenhouse, 264
- Mites, 365, 366, 376-379, 382
- Mixed plantations, 67, 73, 74, 78-81, 180, 436, 443, 487-489
- Moisture control, seed storage and shipment, 513, 515, 517, 518
- Molave forest, 12, 18, 19, 21, 287
- Molluscicides, 344, 383
- Molybdenum, 138, 325, 332
- Monsoon, 5, 12-15, 114
- Morkit, 347, 374, 384
- Mossy forest, 18, 19, 23
- Mother tree, 27, 112, 149, 263, 264, 495, 497, 499-501, 512
- Moths, 188, 367
- Moths balls, 519
- Mould, 363
- Mud-puddling, 269, 310, 311, 313, 314
- Mulching, 81, 103, 114, 119, 138, 261, 273, 284, 288 - 290, 297, 335, 435, 439, 441, 443, 447, 451, 453 - 454
- Multiplication beds for cuttings, 428
- Muscardine fungus (*Metarrhizum anisopliae*), 191
- Mycorrhiza, 321
- Mycoses, 341
- Natural forests, management, 25 - 28  
- , types, 18-24
- Natural regeneration of forests, 94, 112, 130, 159, 197
- Needle cast, 363
- Nemacur P, 356, 365, 378
- Nematocides, 344, 357, 365, 377, 378
- Nematodes, 254, 256, 347, 356, 364, 365, 377, 378
- Net present value, 163, 164
- Nitrate, 328, 329, 330, 331
- Nitrification, 322
- Nitrogen, 10, 120, 136, 138, 266, 324, 325, 328, 329, 331, 334, 336, 342, 362, 363  
- fixation, 72, 136, 322, 336, 337, 324, 325  
- shortage, fresh mulch, 290
- Notching spade, 105, 107
- Nozzles, dusters, 355  
- , hydraulic pressure sprayers, 352  
- , watering hose, 286
- Nursery beds, layout of, 252-254, 269, 297  
- layout, 231-248, 253, 254, 298  
- plants, quality of, 96, 118, 303, 305, 307-309  
- site, selection of, 232 - 235, 242
- Nutrient deficiency, 138, 140, 325 - 327
- Nutrient elements for plants, 46, 136, 137, 316, 325 - 337
- Offspring, 27, 149, 263, 499-502
- Organo-chlorine compounds, pest control, 339, 357, 365, 379, 380
- Organo-mercury compounds, pest control, 339, 342, 346, 348, 356, 377
- Organo-phosphorus compounds, pest control, 339, 365, 366, 369, 378, 380, 381
- Ornamentals, 75, 76, 263, 273, 276, 314, 487
- Orthocide 50, 266, 339, 347, 356, 357, 362, 363, 377
- Oryctes rhinoceros, (see coconut beetle)
- Osmol powder, 239
- Overlogged areas, improvement of, 130 - 135
- Packing and transport of planting stock, 98, 307, 311-313
- Packyaw system, 88
- Paper production, 65, 66, 124
- Parasites on insect pests, 191, 192, 339 - 341
- Parent material, 8, 10
- Parus elegans (*Philippine titmouse*), 192
- Pasture land, 165, 196-198, 406, 408, 409, 414-416, 462
- Patches for planting and sowing, 95, 113
- Pegs, erosion control, 429, 430, 436-453, 474, 476, 478
- Permanent forest, 196, 415, 417  
- nurseries, 231
- Pest control, 338 - 384
- Pesticide application, 346-356, 385, 386
- Pesticides, 179, 338-341, 344-346, 356-359, 375-384  
- , producer and supplier firms, 375-384
- pH-meter, 242, 323, 331
- pH-value, 10, 11, 46, 137, 235, 278, 322-325, 326, 327, 329, 331, 332, 342, 362
- Phenotype, 499-502
- Philippines, climatic conditions, 12-17  
- , geographical situation, 3 - 7
- Philippine soils, 8 - 11
- Phosphorus, 10, 120, 136 - 138, 316, 324, 325, 326, 328, 329, 330
- Physiological disorders in nursery plants, 342, 343
- Pine forest, 18, 19, 23, 25, 27, 158, 197, 407

Pine needle blight (Dothistroma pini), 178, 179  
- shoot moth, 188  
Planimeter, 227  
Plantation records, 40, 41  
Plantations, establishment, 63 - 135  
- , protection, 165 - 198  
- , tending, 91, 130, 134, 136 - 164  
Plant hole, 97, 98, 102, 103, 105 - 109, 119, 120  
Planting, difficult sites, 88-90, 118-122  
- lines, 252  
- plan, 38  
- shock, 97, 112, 133, 305 - 308  
- , site preparation, 92 - 95  
- , spacing between seedlings, 82 - 87  
- stock, 96, 97, 307 - 315  
- survey, 37, 46, 207  
- techniques, 96 - 111, 118 - 122  
- time, 90, 91, 250  
- work organization, 87 - 90  
Plant nutrients, 46, 136, 137, 325 - 337  
Plastic bags for potting, 100, 103, 274, 281  
Plotting of field notes, surveying, 218 - 221  
Plus tree, 499, 501  
Poles, production of, 68-70, 83  
Pole structure, erosion control, 459, 460, 464, 482  
Polyhedral diseases, 191  
Potassium, 120, 137, 138, 324, 325, 326, 328, 330  
Potbeds, 282, 293  
Pots, 69, 100, 103, 118, 273 - 277, 281  
Potted seedlings, 100 - 104, 118, 235, 248, 250, 251, 289, 304, 305, 315  
Potting, 241, 167, 273-283  
- soil, 235, 277-280, 329  
Powder post beetles, 371  
Precautions when handling pesticides, 356-359  
Predators, 191, 192, 339, 341  
Pregermination period, 250, 512, 520-524, 528

Preservatives, wood, 71, 239, 255  
Pretreatment of seed to hasten germination, 250, 512, 520-524, 529, 531  
Preventive measures, erosion, 413 - 418  
- , forest fire, 169, 170  
- , pests and diseases, 179 - 181, 189 - 193, 341 - 344, 346, 362, 372  
- , weeds in the nursery, 297, 298  
Prophylactic measures, pest control in the nursery, 340, 341, 346, 347, 362, 371, 372  
Protection forest, 72, 79, 417  
- of plantations, fire, pests, cattle, 165 - 198  
Protective shelters over nursery beds, 253, 264, 267, 296, 297, 339, 373  
Protractor, surveying, 219  
Provenances, 62, 180, 498 - 502, 525  
Prunners, extension, 506  
Pruning in plantations, 83, 148 - 157  
Psyllids, 367  
Pulpwood plantations, 65 - 67, 79, 81, 83, 124  
Pumps for irrigation, 245, 246, 249  
Pure stands, 67, 78, 79, 180, 190  
Purity percent, tree seed, 525  
Pyrausta machaeralis (see teak skeletonizer)  
Pyrethrum, 340, 383

Quality of nursery plants, 96, 118, 303, 305, 307 - 309  
Quality of seed, 524-531  
Quinine, 70

Rain, damage in the nursery by, 288, 296, 297, 336  
Rainfall pattern, 12-17, 44, 45, 394, 400 - 401, 404  
Rainfall, total annual, 44, 400  
- types 14, 45, 250  
Rain forest, 11, 19, 93, 177, 180, 181, 189, 287

Range management, 196-198, 409, 414 - 416  
Rat control (see rodent control)  
References, Philippine Forestry, 33  
- , Plantation Techniques 109 - 203  
- , Nursery Techniques, 387 - 389  
- , Erosion Control, 491, 492  
- , Tree Seed, 534, 535  
Refining of young stands, 158  
Reforestation, objectives, 25, 63 - 77  
- , adverse sites, 118 - 122  
Reforestation projects, map, 31  
Reforestation, tree species, 51 - 63  
Reforestation work in the Philippines, history, 28-32  
Regeneration, natural, 94, 112, 130, 159, 197  
Reissinger hoe, 102, 105  
Replanting of failures, 91, 95, 96, 116  
Residual inventory, dipterocarp forests, 26  
Retaining walls, 419, 421-423, 456-461, 484, 486  
Revetments, 459, 463, 479, 484, 486  
Rill erosion, 396, 397, 398, 409, 430  
Riprapping, 227, 238, 298, 419, 423, 430, 431, 456-459, 463, 464, 466, 467, 477, 479, 486  
River banks, erosion control of, 394, 398, 399, 402, 419, 425, 426, 429, 449, 453, 473 - 486, 487  
Riverean species, 478  
Road cuts, 394, 410, 418, 428, 433, 444, 445  
Road system, 170, 171, 174, 233, 234, 412, 418, 462  
Rock sausages, erosion control, 482, 485, 486  
Rodent control, 114, 115, 193 - 195, 344, 346, 373, 374, 384, 518, 519  
Root formation, treatments to promote, cuttings, 266  
Rooting horizon, 97 - 99  
- hormones, 265, 266  
- medium, cuttings, 262, 263, 264, 267

Root nodules, 136, 322  
- protection during planting, 98, 269, 311, 312  
Root pruning, after lifting, 108, 268, 302, 307, 310  
- , tending measure, 257, 302, -305  
Root rot, 177, 361, 377  
Rootworms, 369  
Rotation of stands, 68, 79, 150, 163  
Rotor tillers, 94, 236, 301  
Royalty rates, 163  
Rubber, 70  
Rubble drain, 432  
Run-off, 120, 396, 402, 410, 412, 431, 433, 436, 451, 462 - 464, 467, 483, 485, 487  
Rust, 177, 180, 363, 376

Saltation, 399, 403  
Sampling, diagnostic, natural regeneration, 130  
Sampling of failures in young plantations, 116, 117  
Sampling, seed testing, 525, 526  
Sand, 234, 235, 241, 255, 258, 260, 278, 279, 280, 288, 314, 317, 403, 404, 411, 418, 420, 432, 445  
Sands, coastal, 118, 120  
Sand stone, 8, 9  
Sandy loam, 234, 235, 255, 288, 318  
Saplings, 133, 145, 443  
Sawdust, 289, 334  
Sawflies, 367  
Sawnwood, production of, 64, 83, 500  
Scab, 363  
Scale insects, 367, 370  
Scarification of seed, 522  
Secondary forest, 69, 92, 130, 234, 235  
Sedimentation, 399, 403, 411, 471 - 473, 475, 476, 478, 480  
Seedbeds, 247, 251-254, 296, 299, 342, 374  
Seedboxes, 240, 254-256, 261, 296, 298, 342, 347, 362, 365  
Seed certification, 496, 497  
Seed collection, 90, 495, 496, 499, 501, 502, 503 - 508, 509  
Seed dressings, 114, 340, 342, 346, 356, 362, 373, 374, 376, 377

Seed extraction, 241, 509-511  
Seeding, direct (field), 94,  
113 - 115  
Seed maturity, 242, 503 - 505,  
512, 525  
Seed orchards, 84, 501, 502  
- origin, 498 - 502, 509  
- quality, 524 - 531  
- quantity, 114, 530-533  
- shipment, 497, 505, 509,  
517 - 518, 531  
- size, 525, 532, 533  
- sources, 495 - 502  
- storage, 241, 381, 497,  
505, 509, 512 - 516, 518,  
519, 524, 531  
- viability, 71, 113, 260,  
497, 503-505, 512-520,  
527 - 531  
- weight, 525, 532, 533  
Seed years, bamboo, 70  
Selective logging, 25-27  
Self-pollination, 501  
Sevin, 367, 368, 369, 383  
Shade tolerant species, 81,  
131, 142  
Shading, 260, 264, 267, 273,  
282, 284, 290 - 295, 306,  
342, 343, 362  
- mats, 240, 291, 294,  
296, 371  
- screens, 295  
Shale, 8, 9  
Sheet erosion, 396, 397  
Shelterbelts, 73 - 75, 233,  
487 - 489  
Shelters over nursery beds,  
251, 253, 255, 264, 267,  
296, 297, 339, 373  
Shifting cultivation, 11, 18,  
122-130, 165, 169, 402,  
408, 416, 417, 427  
Shocking of potted seedlings,  
304  
Shoot borer, 61, 62, 81, 135,  
149  
Shoot pruning, 188, 306, 307,  
310  
Silt, 317, 318, 403  
Siltation, 470-473, 475-478,  
480  
Site classes, 43-50, 161, 162  
Site conditions, with regard  
to field planting 50, 83, 86,  
88 - 90, 101, 103, 104,  
118 - 122  
Site preparation for field  
planting, 91, 92-95  
Skeletonizers, 186, 187, 367  
368  
Skeleton percent in soils, 48  
Slope reduction table, 211  
Slopes, erosion control, 402,  
403, 408, 409, 415 - 418,  
424-472, 489  
- nursery, 237, 238  
- plantations, 85, 103,  
118, 121, 122, 142, 165, 167,  
168, 174, 193, 196  
Slugs, 372, 373, 383  
Slurry treatment, 346  
Snails, 372, 373, 383  
Sodding, 427, 428, 431, 452,  
453, 463, 484  
Sodium arsenite, 134, 135,  
146, 147  
- nitrate, 324, 328, 329  
Soil analysis, 327  
Soil classification, 8-12, 46-49,  
317-318, 403-405  
- creep, 394, 404, 413  
- crust, 288, 300, 318  
- description, soil profile  
in the field, 46 - 49  
- drenching, 347, 348, 362,  
369, 376, 377  
- fumigation, 340, 347, 362,  
365, 377, 378, 379  
- insects, 346, 347, 348,  
356, 369, 377, 378, 379, 380,  
382  
- management in the nursery,  
234, 251, 255, 256, 277-280,  
316-337  
- mixing, 241, 255, 256, 260,  
280  
- organisms, 49, 289, 319,  
320-322, 334  
- pores, 49, 318, 319, 396,  
396, 404, 405  
- profile, 11, 46, 47, 140,  
397, 405  
- reaction, 10, 11, 46, 137,  
235, 278, 322-325, 326, 327,  
329, 331, 331, 342, 362  
- shed, 241, 278-279  
- structure, 46, 48, 49, 235,  
251, 288, 289, 318, 319, 396,  
404, 405, 406  
Soils of the Philippines, 8-12  
Solid structures, erosion control,  
435, 456-472, 464-470, 473,  
484-486  
Sowing, field, 94, 113-115  
- nursery, 90, 249-262, 362

Spacing of forest plantations,  
82-87, 94, 120, 126, 130-134,  
152, 159-164, 435  
Spacing of transplanted seedlings  
in the nursery, 269, 282,  
342, 362  
Species (see tree species)  
Splash erosion, 288, 395, 396  
Spray additives, 345, 353, 384  
Spraying, 174, 285, 287, 348-354,  
454  
Spray liquid, preparation of,  
353, 354  
Spreaders, spray liquid, 345,  
353, 384  
Sprinkling, 236, 245, 246, 249,  
261, 285, 286, 287, 348  
Spurs, erosion control, 486  
Stand improvement, 27, 248-164  
Stemborers, 368, 379, 382  
Sterilization of soil, 256, 298,  
339, 340, 342, 347, 359, 360,  
362, 365, 369  
Sticker, spray liquid, 345, 346,  
353, 354, 384  
Stream banks (see river banks)  
Striplings (see saplings)  
Strips for planting and sowing,  
93, 94, 113, 131, 132  
Stumps, 62, 106, 109, 110, 122,  
235, 269, 302, 313, 314  
Subsoil, 47, 316, 397, 411  
Sucking insects, 366, 367, 380,  
381, 382, 383  
Sulphur, 322, 324, 325, 332  
Sunscald, 290, 343  
Superphosphate, 329, 331, 332  
Surveying, 207-228  
Survey, planting, 37, 38, 46  
Survival rate, nursery plants,  
103, 104, 111, 112, 115, 116,  
117, 250, 273, 307-309, 530, 531  
Systemic insecticides, 3410, 367,  
368, 382  
2,4,5-T (see arboricides)  
Tabás, 143  
Tanguile-Oak forest, 19, 21, 23  
Tap root, 97, 113, 115, 302-305,  
310  
Taungya plantations, 58, 81, 84,  
92, 123-129, 417  
Teak defoliator, (Hyblaea puera),  
183-185, 187, 191, 192  
Teak skeletonizer (Pyrausta  
machaeralis, syn. Hapalia macher-  
alis), 186-187

Temperature, atmosphere, 15,  
45, 168, 290  
Temperature control during seed  
storage and seed shipment,  
513, 515-517  
Temperature, soil, 288, 290  
Temporary mixtures, 81, 82  
- nursery, 111, 231,  
233, 238  
Tending, nursery plants, 283-306,  
329-333, 341-344  
- plantations, 91, 130,  
136-164  
Termites, 181, 190, 347, 348,  
370, 371, 380, 510  
Terraces, nursery, 234, 237-238,  
297, 298  
Terracing, erosion control,  
433, 434, 436, 458  
Terracur P, 356, 365, 369, 378,  
382  
Texture class (see soil texture)  
Thinning, plantations, 69, 79,  
81, 158-164  
- seedbeds, 258, 362  
Thiodan, 341, 356, 367, 368, 380  
Thiovit, 340, 356, 363, 376, 379  
Thrips, 366, 382  
Thuricide, 341, 368, 383  
Tie points (lines), surveying,  
207, 209, 220, 222  
Timber quality, 83, 115, 148-157,  
187-189, 498-502  
- trees, 51-62, 65, 94,  
130-135  
- stand improvement (see  
stand improvement)  
Tin cans, pots, 100, 103, 275-277  
Tires, slope stabilization, 460,  
461  
Titmouse (Parus spp.), 192  
Tool room, 240, 241  
Tools and implements, nursery,  
241, 242, 252, 258, 259, 270-272,  
275, 276, 278, 281, 285, 286,  
299, 300, 304, 309, 310  
- plantations  
(weeding, pruning, fire control)  
142, 143, 151, 152, 176  
- planting,  
101, 102, 105, 106, 108  
- pest  
control, 349-352, 355, 360  
- seed  
collection and extraction,  
506, 507, 509-511  
Top/root ratio of nursery plants,  
250, 303, 305, 308

Topsoil, 47, 90, 236, 238, 241,  
255, 278, 316, 396, 397, 411,  
453, 454, 477  
Trace elements, 138, 324, 325,  
326, 332, 334, 360  
Tractor, 109, 234, 241, 245,  
251, 301  
Trade names of pesticides, 344,  
376-384  
Transpiration, 73, 119, 283,  
284, 287, 288, 290, 305, 307,  
412  
Transplant beds, 247, 269, 289,  
299, 301, 302, 303, 304, 342,  
348  
Transplanting in open beds, 250,  
251, 257, 268-273, 302  
Transport of planting stock,  
233, 234, 311-314  
Traverse, close, surveying,  
222-227  
Tree farming, 32, 65-67, 124  
- killers (see arboricides)  
- marking, liberation cuttings,  
160  
- , selective logging,  
25, 26  
Tree percent, 530-531  
- poisoning, 81, 94, 131, 134,  
146-148  
Tree species, fast growing, 66,  
67, 83, 113, 124, 140, 500  
Tree species for reforestation,  
43-77  
Trial plantations, 65  
Triangulation, surveying, 217  
Trimming, roots, 108, 268, 302,  
307, 310  
- , shoots, 188, 306, 307,  
310  
- , strong branches,  
plantations, 156, 157  
Typhoons, 13, 14, 15, 16, 17,  
73, 171, 233, 418, 441, 463  
  
Underplanting, 81, 130-135  
Undesirable trees in plantations,  
158-162  
Urea, 324, 328, 329, 331  
Urodinales (see rust)

Value, thinning operations,  
163, 164  
Vegetation, ground cover, 112,  
113, 167, 175, 190, 211, 234,  
405-409, 411, 412, 414-417,  
424-429, 470, 473, 483, 484,  
487-489  
Vegetative propagation, 262-267,  
501, 502  
Velocity of flow, erosion control,  
247, 399, 402, 462, 471, 472,  
475, 476, 479, 480, 483, 484  
Veneer pots, 100, 277, 281  
Viability of seed, 113, 250,  
260, 497, 503-505, 512-520,  
526, -529, 531  
Virus diseases, 191, 341, 361  
Volcanic tuff, 5, 7, 8, 10  
Volume production of timber,  
66, 67, 83, 136, 139, 140, 162,  
163, 500  
  
Water absorbing capacity of soils,  
10, 11, 120, 289, 317-320, 401,  
403, 405, 406, 412, 436, 462  
Waterbuck, 245, 246  
Waterfall erosion, 397, 463  
Watering, 261, 268, 273, 283-288,  
342, 343, 350-352, 362  
Watershed, 32, 72, 197, 401-403,  
411, 412  
Water-spill, 464, 466, 467, 485  
Water storage capacity of soils,  
73, 287, 288, 317-320  
Water table, 46, 243  
Waterways, 398, 399, 402, 412,  
417, 431, 433, 473-486, 487,  
489  
Wattling structures, erosion  
control, 438, 439, 446-452  
Webworms, 368  
Weed control, chemical, 144, 301,  
302, 343  
- , nursery, 257, 258,  
273, 297-302, 341, 359, 362  
- , plantations, 91,  
93, 115, 122, 126, 133, 134,  
138, 141-144  
Weed seeds, 248, 256, 284, 297,  
298, 333, 347, 377, 378  
Weevils, 367, 519

Weirs, 419-423, 484, 495  
Wells, nursery, 243, 244  
Wettable powder, 345, 353, 356  
Whiteflies, 367  
Wildlings, 51, 71, 103, 111,  
112, 133, 314  
Wilt, 363  
Wilting, 137, 291, 343, 365  
Wilting point, 404  
Wind, 15, 52, 73-75, 157, 164,  
167, 168, 174, 233, 240, 288,  
297, 355, 394, 487-489  
Wireworms, 369, 382  
Wolf trees, treatment of,  
157, 158  
Wood preservatives, 71, 239,  
255, 350

Yakal-Lauan forest, 19, 20  
Yield table, 52, 160

Zinc, 138, 324, 325, 332  
Zineb, 339, 344, 363, 376