

Rainwater Reservoirs above Ground Structures for Roof Catchment

by Rolf Hasse

A Publication of Deutsches Zentrum für
Entwicklungstechnologien -GATE
in: Deutsche Gesellschaft für Technische
Zusammenarbeit (GTZ) GmbH - 1989

Preface

This paper was written in the Botswana village of Romotswa in 1987, the seventh year of drought in Southern Africa. Romotswa has a history of rainwater catchment. Many of the private buildings as well as public buildings are equipped with reservoirs, most of them dating from the time before municipal water supply existed. In 1983 a large underground water source was detected here by geologists. The yield of the drilled wells is of such magnitude that for some time in 1984, the towns of Gaborone, the capital of Botswana, and Lobatse were both supplied with water from Romotswa. During my residence in this little border village in SouthEast Botswana, 30 km away from the capital, I noticed that rainwater catchment had lost momentum as a result of the centralized water supply. Many of the catchment facilities were poorly maintained so that much of the rainwater during the rare but heavy downpours was lost due to gutter leaks and/ or dislocated downpipes. At the same time newly built schools and other public buildings had been equipped with reservoirs which were much too small for the huge catchment areas. It became obvious that no calculations and no design for the systems had been made. Unprofessionally fixed gutters and downpipes were another problem. It should be mentioned that drought in Botswana, as in other parts of the world's desert belt, does not mean that no rain occurs at all. It simply means that the mean annual rainfall has not been reached and sometimes -just as serious - that the distribution of precipitation is extremely unequal. In such unfavourable climatic conditions heavy downpours of up to 100 mm in one hour do more harm than good to the arable land. The water does not penetrate the very dry and hard soil and the massive runoff results in severe soil erosion. Together with my experience gained as Town Architect in Lobatse, all these observations have influenced the structure of this paper. Originally planned as a technical manual for the construction of reinforced brick tanks, it became clear that the entire issue of rainwater catchment and storage should be put into a broader context. At the same time UNICEF, Kenya, had approached the Editor with the Laurie F. Childers manual for a ferro-cement tank. It was agreed that the accumulated knowledge in this paper should be used to provide an introduction of different techniques for building rainwater reservoirs. Since the possibilities of building rainwater reservoirs depend entirely on the availability of the required materials, it is the intention of this publication to cater for a variety of situations. N.J. Wilkinson of the Botswana Technology Centre has published a manual showing another technique of building a ferro-cement tank. This technique has advantages under certain circumstances. E.H. Robinson has erected structures for "Christian Action for Development in the Caribbean" using another technique. Each of the different structures has its advantages. Which one should be chosen depends on the situation at the specific site. Much emphasis is placed on material testing and mixing. Here the advice given by Childers matches the experience I have made with waterproof cement plaster and

which has not been mentioned in any other publication. Only a careful screening of river sand and uniform mixing will result in waterproof structures. The nit is an equally important coat often forgotten, and the necessity of curing cannot be overemphasized. An article by Kiran Mukerji in "Trialog" describes his experiences in India with the construction of a rainwater reservoir. He had chosen an interesting two leaf structure combining the ferro-cement technique with air-dried clay bricks, using the latter as permanent shuttering. He stresses the need for professional artisans and limits the possibilities for self-help construction. Having worked for seven years in different African countries, I can confirm that this reflects my own experience, and leads me to comment on appropriate technology. This term is often misunderstood for different reasons. The first is that too many academics from developing countries have been educated in the western industrialized world. Because of their academic orientation, they have little practical technical knowledge. They consider appropriate technology to be a second-class technology invented by the industrialized north, good enough for the poor south. More often than not they prefer to discard traditional technical knowledge. A second reason is that some aid organizations have indirectly supported these arguments by allowing their engineers sent to developing countries to use techniques which are not appropriate to the economical, technical and social background of these countries. The windmill designed and manufactured for borehole pumps will not replace the diesel pump if it costs 20 times more than the latter as long as cheap fuel is available at all times. The plough which is manufactured from scrap has the advantages of being labour-intensive and recycling material, but its success is only assured if a comparable industrial product is not available. This means that appropriate technology must first of all be a technology which is based on a cost-benefit analysis. Secondly it is difficult to create a motivation, which is needed to achieve the acceptance of any new technique. It is therefore of fundamental importance that the manufactured product works properly. Techniques which function poorly or not at all result in frustration, demotivation and resignation, and for many years people will be reluctant to accept any change. The consequence of this must be that appropriate technology also requires professional engineering. According to my experience it is more appropriate to train and instruct a contractor and his already qualified craftsmen than to use unskilled labour in self-help construction projects without professional supervision. In construction work there are many jobs which can be done by unskilled labour, but substituting casual labour for trained plasterers should not be tried.

This manual offers advice on a more professional approach towards rainwater catchment and the construction of different types of reservoirs. It also offers a selection of the most appropriate reservoir types and gives technical advice for the construction work. As far as possible it has been kept on a level which would allow an experienced bricklayer to use the information or a building technician acting as Clerk of Works or Supervisor to advise bricklayers and plasterers on the site. It is not suitable for laymen in the construction field. Just as it is not possible to learn the technique of bricklaying by reading a book, it is not possible to write a construction manual imparting all the knowledge needed for people without the practical experience in the construction field.

Finally I wish to thank Karin Bell who did the illustrations and Siggi Gross who took the photographs.

Special thanks go to my colleague Frederick McKelton who corrected the manuscript.

Rolf Hasse

Content

Preface.....	1
1. Introduction.....	4
2. Catchment possibilities and choice of reservoir types.....	11
3. Material testing and mixing	21
4. Installation of a corrugated iron tank	27
5. Construction of ferro-cement reservoirs.....	30
6. The reinforced bricktank.....	64
7. Gutters and downpipes.....	81
Appendix: Technical drawings.....	83

1. Introduction

1.1 Brief outline of the history of rainwater catchment technologies

Rainwater harvesting and storage do not constitute a new technology. Small dams and runoff control means for agricultural purposes can be traced back to early history. An example of this are the rice terraces in the Philippines. In use for thousands of years, they still prove to be an efficient technique today. The use of earth dams to control runoff was also known in ancient Egypt.

Archaeologists found a sophisticated rainwater collection and storage system on the island of Crete while working on the reconstruction of the Palace of Knossos (1700 B.C.). However, with the development of building construction based on new materials such as lime and burnt clay bricks, new construction techniques like arches and domes developed. The ancient Romans became masters in rainwater harvesting and the construction of reservoirs. It was this new technique of building closed cisterns, and at the same time the urbanization within the Roman Empire around the Mediterranean, which resulted in the development of a rainwater catchment culture at all those places where water resources were limited. This is why old rainwater cisterns are to be found on the islands of Capri and Malta and at places of historical interest in Spain and Turkey, in the Lebanon and on the island of Sicily.

It appears that the rainwater harvesting technique used in the Roman houses was based on the experience gained in Knossos.

"Through a small anteroom (vestibulum) a closed internal court is reached (atrium) which has a pool in the centre into which the rainwater from the roof flows. The pool is lined inside with ceramics and has sloping sides. The atrium is closed behind by the sitting room (tabunium) which leads into a larger internal court (perstilium) where a second pool collects water from the roofs of the rooms surrounding the court".

Many of the ancient systems, including the Roman rainwater catchment techniques for housing, served a double purpose. The evaporation of the water in the pools improved the microclimate through its air-conditioning effect, and the water was used for domestic purposes. As a result of urbanization, increased density of plot coverage and growing population, the consumption of water also increased. This led to the development of covered cisterns. These were built in the ground underneath the courts. This had two major advantages: firstly, the amount of water which could be stored was increased considerably and evaporation losses were reduced. Secondly, the cisterns served as a protection against pollution of the water. The more sophisticated houses still had the shallow pool in the atrium. All the rainwater from the roofs flowed into the pools and an overflow drained into the cisterns. At this time rainwater catchment techniques were decentralized, and this may be the reason why they lost momentum with the increasing consumption and the development of a centralized supply from springs channelled into the urban areas. However, few examples of centralized rainwater catchment and storage in cisterns are known.

Probably the world's largest cistern is the Yerebatan Sarayi. On the European side of Istanbul in Turkey, it was constructed under Caesar Justinian (A.D. 527-565) and measures 140 by 70 metres. It can store 80,000 m³ water. The underground structure is based on intersecting vaults. Nowadays it has turned into a tourist attraction which can be visited by boat, drifting through a forest of columns. Another cistern in Istanbul is called Binbirdik and has a capacity of 50,000 m³. Sources are unclear as to which of the cisterns is the older. It could be the Binbirdik if constructed under Caesar Constantine (A.D. 329 - 337) as one source suggests. Both cisterns served as centralized storage. The water was collected from roofs and paved streets and a sophisticated system of filters assured clean water. However the municipal underground cisterns in Istanbul are probably the only examples of urban centralized rainwater harvesting of their kind. There are probably two major reasons why

this technique was no longer used. Firstly, the construction of underground cisterns is considerably more expensive than the construction of dams. Secondly, there is a danger of accidental pollution through human excrete in dense urban areas and therefore a risk of epidemics.

Although rainwater harvesting and storage in closed cisterns were never used again to the same extent as in ancient Rome, they were occasionally employed where circumstances demanded an appropriate technology. This happened in semi-desert areas where people wanted to build homes without springs or wells in the vicinity. The technique was often used when Christian monks built their monasteries. Many of these examples still exist in the former Spanish Empire and monasteries in Mexico, for instance, provide evidence of the high standard of design and construction.

The technique disappeared with increasing urbanization. It can be assumed that the technical means available during the industrial age, the need for supplies of large amounts of water for industry, the high standard of water hygiene achieved through central treatment and safe supply via pipes are all reasons for the reduced use of rainwater harvesting. But modern water technology not only has advantages. Its disadvantages are as follow:

- The centralization of supply involves the risk of total cut-off in cases of natural disaster (earthquakes etc.), destruction through acts of war (bombing etc.), and source pollution (environmental pollution through chemicals). This is the vulnerability of a modern centralized water supply.

- The consumption of water is not only based on need, but very much influenced by the convenience of access. It can be observed everywhere that water wastage is the rule rather than the exception. This is based on an economy which has made one source of life a commodity of consumption and represents the contradiction between the need for careful management of world resources and an economy based on permanent expansion. However' in general there can be no doubt that there is no alternative to a centralized water supply in urban areas nowadays.

Rainwater harvesting is gaining importance again, this time in rural areas and especially so in many developing countries. The present situation in developing countries demands the utilization and development of all possible sources to ensure the supply of water.

Much has been published about rainwater reservoirs for rural housing. Less emphasis is given to the construction of large reservoirs as stand-by facilities. Likewise not much is known about the possibility of using rainwater as raw. water and by doing so of reducing the consumption from centralized supply. The following section will show that the use of rainwater combined with the saving of water and reuse of waste water can be an economic solution when considering the rising cost of pipeborne water.

1.2 Rainwater catchment at public buildings in Lobatse, Botswana

The following shows what can be done in a semi-desert country where water shortages are frequent, and how rainwater catchment and storage can become an economic solution.

In April 1983 the drought in Botswana entered its third year. Lobatse, a small town with about 20,000 inhabitants situated 70 km south-west of the capital, Gaborone, is usually supplied with water from two nearby dams. The town is a "Waterworks Area" which means the supply is centralized and organized by the W.U.C. (Water Utilities Corporation). Although Lobatse has two groundwater basins, this water is not used in the central supply system. In April 1983 tight water consumption restrictions came into force, since both dams had dried up. The central supply system then received its water through a 70-km pipeline from Gaborone. The restrictions prohibited the use of water for

gardening, car washing, swimming pools and even construction work. The only three institutions in town in possession of their own boreholes were the B.M.C. (Botswana Meat Commission), the Zimbabwe Railways (now Botswana Railways) and the Town Council. However all boreholes raised water that was considered not fit for human consumption. The Council borehole was linked to an irrigation system for the lawn in the stadium. Since the groundwater in Lobatse was not included in the restrictions, the Council was also allowed to irrigate the stadium lawn. This was very fortunate since the development of the stadium lawn and the maintenance of it until then had already cost a lot of money.

The major problems for the Town Council, however, were schools and clinics. At four primary schools, two clinics and one day care centre vegetable gardens were drying out. Traditionally, the diet of Botswana is carbohydrate-and protein-based. An extensive government programme made vegetable growing a compulsory educational subject for all primary schools. At the local clinics where special care is taken of children and their mothers, vegetables are grown and cooking is demonstrated. The big question was how all these activities could be maintained without sufficient water. Also, at the same time, hundreds of newly planted trees had to be watered. The Council owned two water trucks and after the stadium borehole had been provided with a standpipe, watering of trees was carried out with water trucks (bowzers). The schools and clinics were provided with old drums which had to be filled up once a day. The watering of trees worked because they were big enough to withstand short interruptions of the water supply without serious consequences. The supply for the four schools, two clinics and the day care centre was not satisfactory. A breakdown of a tractor could result in considerable problems. Since the borehole had to supply the stadium irrigation system and to fill all the bowzers, special arrangements for the staff had to be made. The first groups started working at 4 a.m. and bowzers were still on the road at 7 p.m. The bottleneck was the temporary storage of water in drums at the public buildings. The investment in drums became substantial since they were often stolen and had to be replaced. There was an obvious demand for better storage.

This resulted in the development of the dual system as it was then called. The dual system meant that rainwater reservoirs were built at the public buildings and always kept half filled with borehole water. When it rained the reservoirs filled up with rainwater, and when they became empty they were filled with two or four bowzerloads, depending on their size, and this could be timed properly. Early in 1986, all primary schools, the day care centre and the clinics were equipped with reservoirs and catchment systems. In addition a newly built community centre was equipped with a 59-m³ reservoir. Within three years and with only limited funds, an overall storage capacity of about 437 m³ was achieved (see Table 1).

Sizes of the reservoirs constructed differ due to the layout of the schools and the catchment possibilities. Only the Woodhall Community Centre, which was built in 1985, was designed according to the catchment needs.

Although tight water restrictions were lifted in 1985, the system remained in use unchanged. The reason was the tariff policy of the Water Utilities Corporation. Water in Lobatse is sold for a higher price than in other towns because the supply is very expensive.

Location of reservoir	Number of tanks	Type of structure	Total capacity in litres	Filling cost on basis of WUC tariff, 1987
Peteng clinic	1	reinforced brickwork	21 195.0	29.25 P*
Woodhall clinic	1	reinforced brickwork	21 195.0	29.45 P
Woodhall School phase I	2	corrugated iron	16 000.0	9.68 P
Hill School	1	reinforced brickwork	47 688.0	74.03 P
New Look School	2	reinforced brickwork	79 481.0	154.60 P
Woodhall School phase II	5	corrugated iron	40 000.0	54.80 P
Ipeteng School	2	reinforced brickwork	95 377.0	193.90 P
Day Care Centre	1	reinforced brickwork	41 599.0	59.24 P
Woodhall Community Centre	1	reinforced brickwork	58 875.0	102.30 P
Woodhall School phase III	2	corrugated iron	16 000.0	9.68 P
Total 1986	18		437 410.0	717.13 P

* P = Pula, Botswana currency. In Nov. 1987 1 P = DM 1.05 or US \$ 0.62

Table1: Rainwater reservoirs at public buildings in Lobatse, Botswana

The reason for not fixing a uniform tariff throughout all towns (W.U.C. supplies water in urban areas only) is to keep people aware of the more or less permanent shortage of water with emphasis on areas where the supply becomes very expensive. As a result of growing urbanization (Botswana's urbanization rate in the past was 11.2% per year, one of the highest in the world) more and more investment was necessary for well drilling, dam raising and pipeline construction. As shown in Table 2 water tariffs have been increased each year since 1982. The tariff is stepped up and the table calculated on the amount of 50 m³ and more. The tariff for the first 10 m³ is much lower but was also raised from 2.30 pula in 1982 to 5.20 pula in 1987. That is equivalent to an increase of 126% within just five years. However, prices for water consumption of 20.50 m³ and more increased much more. As the table shows, 50 m³ in 1982 cost 30.10 pula; the 1987 cost is 80.10 pula. This means an increase of 166% which is more than two and a half times the cost of five years ago. It could be argued that another tariff policy would be more justified. However, the system in use has definitely supported water saving and the rainwater reservoirs at public buildings in Lobatse become more and more economical. The costs of filling given in Table 1 are based on the sizes of the reservoirs, not on the consumption. It is unfortunately not possible to state an average amount of consumption since gardening is of different intensity and gardening areas vary. Refilling of all reservoirs is done three times a year if there has been no rain. This suggests a consumption of about 1,300 m³ equivalent to costs of 2,150 pula. This amount would still cover the construction Cost of a reinforced bricktank capacity of 21 m³. As the example shows, this dual systems is economically efficient. At the same time, the reservoirs are an ideal stand-by facility. Given the case that the centralized system may be temporarily not functioning, the cisterns could supply the population in the area of location. As all reservoirs are closed, a treatment with chlorine could make the water safe for use. Since it can be observed everywhere that the highest consumption of water is in areas where drinking water quality is not imperative, raw water should be used as much as possible.

Finally it should be mentioned that tree planting and keeping are not primarily decoration, but satisfy an environmental demand. Botswana is very much affected by soil erosion. The Government therefore directs that all support should be given to tree planting. An annual tree planting day enjoys public attention and nurseries are being founded in many places. Therefore, any water consumption restriction has a substantial effect on environmental conservation. Hence unconventional ways had to be found to continue environmental conservation while at the same time saving as much water as possible.

Year	Cost of 50 m ³ (P)	Cost of next 20 m ³ (P)
1982	30.10	16.81
1983	30.10	16.80
1984	46.20	23.00
1985	59.00	32.20
1986	59.00	43.60
1987	80.00	50.60

Table 2: Development of water tariffs in Lobatsa

1.3 Water saving and reuse of water

1.3.1 Domestic water saving

1.3.2 Bath or shower

1.3.3 Reuse of domestic water

1.3.4 Conclusion

Water saving in semi-desert countries is essential and should be encouraged as much as possible. To support saving, it is first important to understand how water is wasted.

By way of example, let us consider a selfhelp housing area. In Botswana this area is supplied through standpipes on the side of streets, never more than 100 metres away from a house. Tenants are supposed to build pit latrines before they are allowed to construct dwelling rooms. People fill containers several times a day and carry the water home. Although the supply of water is much better than in villages and distances are much shorter, the water still has to be carried. One who has to carry water to the point of use will hardly waste it, and exactly this is the experience gained. It was observed that people became used to collecting their washing water after use, and watering their plants in the courtyard. As the water bills in Lobatse showed, consumption of water per standpipe in self-help housing areas, although used by 7-10 families, is lower than the consumption for one high cost house. It has been suggested that the consumption in residential houses rises with the number of taps and other sources connected to the central supply. Unfortunately, statistics are not available but observations appear to confirm this. However, the conclusion from the above should not be to propose public standpipes as a solution. The general conclusion can only be that the convenience of access to water raises consumption. If this is understood, we should have a close look at possibilities of saving domestic water.

1.3.1 Domestic water saving

In domestic water use the waterborne toilet system, in general, is the highest consumer of water. Moreover, the water used is not fit for reuse and goes into the sewers. Recycling of sewer water is possible but expensive and can only be done in special ponds. It has been observed that at a school with water closets (12 toilets each consuming 10 litres per flush), the consumption of these flush toilets is higher than the consumption of 1000 pupils and their teachers for drinking, cooking one

meal a day and washing the dishes. Consumption reduction means first reducing the consumption by the toilets. Flushing valves consume less than flushing cisterns, but they are not appropriate since they require a permanent high water pressure not always available in developing countries. There are producers of toilets consuming 4 litres of water per flush in Sweden, Great Britain and West Germany. Imports of this highly appropriate system into developing countries, where there is a real need to save water, should be encouraged. In Botswana this was done by the Botswana Technology Centre in Gaborone. This institution had discussions with wholesalers whom they persuaded to import a reasonable number. At the same time the centre spread information about this new system. Introduction of a new system like this takes time since people have to be convinced that the higher investment really brings returns. But there is also something that can be done about the existing highly wasteful cisterns. Some can be adjusted to lower levels of filling by bending the bow of the cistern float downwards. This results in stopping the filling water at a lower level. It is also possible to put stones around the off-flow of the cistern. The volume of the stones (blocks) will be the volume of water saved, at the same time raising the water level to the adjusted cistern float. Depending on the type of cistern the consumption can be reduced to 7 or even 6 litres, but the cleaning effect of flushing is reduced since the toilet bowl is not designed for such low consumption.

1.3.2 Bath or shower

It is often not realized that the amount of water consumed for one bath is sufficient for three showers. In consequence this would mean that houses should be furnished with showers rather than with baths. But baths have become a status symbol in many countries, and a high cost house must be furnished with a bath. The amazing thing is that baths in Europe are rather out of fashion and much less used than showers which produce savings in both water and time. From the hygiene point of view showers are better than baths. If a bath is installed this should always be done in such a way that a shower battery is fixed, so that the bath can also be used for showers. At the same time the built-in bath should be chosen carefully since the capacity varies substantially. Several devices are on the market designed to reduce water consumption. Spray nozzles for showers, push button taps etc. might reduce consumption, but should be studied before use. When deciding on water saving equipment one has also to consider the lime content of the water. Lime precipitates at 60 °C. This means that sensitive equipment in hot climates will soon clog.

1.3.3 Reuse of domestic water

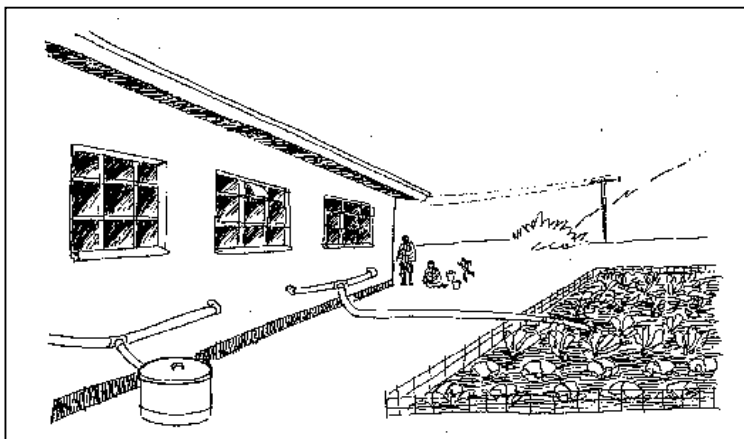

figure 1.3

Major sources of water consumption in residential houses are the kitchen sink, the bath and/or shower, the basin in the bathroom and the toilet. While for obvious reasons the reuse of water from the toilet is not possible, the bathroom water, although contaminated by soap and through laundry

by washing powder, can be used for cultivation, even for vegetables if directed at the soil. One vegetable gardening area of 150 m² at a clinic in Lobatse was irrigated with water from sinks and hand basins only for a period of one year, and showed very successful results. At this clinic only one sink was used for washing drug containers and equipment used for medical tests. This waste water was drained into the sewer. All other waste water was drained into drums dug into the ground (see Fig. 1.3). The water was then extracted with buckets and used for gardening. Experiments at private residential houses have shown that the reuse of water for gardening does not affect the plants, if the water is drained into the soil surface only. This does not generally apply to water running out of the kitchen sinks. Water from dishwashing usually contains too much grease and is therefore not suitable for most plants nor for vegetable gardening. But this water can be successfully used, for example, for cultivation of banana plants. Bananas should not be planted closer than 15 metres to a residential house because of mosquito breeding.

There are two ways to reuse domestic water. The first, as stated, is to disconnect the pipes of the sink outlets and fit hoses draining the water into drums dug into the ground.

These drums must be provided with lids because of the danger of mosquito breeding. Water is then lifted out with buckets. The other and more convenient method is to connect long hoses direct to the outlets and draw the water straight to the place of use.

Where rainwater is available and not used for the household and as drinking water because of an existing centralized supply, it should be used for vegetable gardening and the waste water for cultivation of trees and other plants (see Fig. 1.3). Vegetable gardening with waste water requires the cultivation of vegetables where only the above-ground part of the plant is eaten, and the water is spread on the soil, and not sprayed onto the leaves.

1.3.4 Conclusion

The water catchment possibility is always limited to the amount of rainfall, as is the storage capacity. Therefore, dependence on rainwater should always be seen in correlation with water conservation.

2. Catchment possibilities and choice of reservoir types

2.1 Cost-benefit ratio

It is virtually impossible to provide a general cost-benefit analysis of the different types of reservoirs and storage capacity because of the many unknown factors. However, the following general indicators for decisionmaking can be given.

1. The value of rainwater rises with increased distance to or inaccessibility of other water sources. This means that if rainwater becomes the only source, its value is extremely high. Thus the high investment in a large reservoir becomes cheaper in relation to the value of water.

2. If rainwater remains the only source of water, rainfall patterns must be studied carefully. If the pattern shows a more equal distribution over a long observation period, it is possible to choose the size of a reservoir according to the precipitation, even on a semi-annual basis. Where the rainfall is extremely unevenly distributed with frequent drought periods, a reservoir should be as large as possible, based on the maximum rainfall. This is expensive but still economic after taking all other factors into account.

3. It is imperative to analyse the purpose of water use and the volume of consumption in advance. Only rough indicators can be given since the consumption will vary from case to case. Rural households in Africa often manage with 40-60 litres of water per day. As mentioned earlier, since easy access does not encourage saving, but on the contrary consumption increases, arrangements should be made to provide additional amounts. Water consumption rates for cultivation cannot be given since this depends largely on the type of crop and soil conditions. If the planned reservoir is expected to serve as a stand-by facility because of frequent breakdowns of a centralized supply, the size can be smaller and the capacity limited to the consumption of a few weeks, depending also on the rainfall pattern.

4. Access to construction materials is another factor to be considered. For instance corrugated iron tanks which are usually very economical might be available only hundreds of kilometres away and therefore become too expensive. Or if reinforcement mesh is not available, a ferro-cement tank cannot be built (see Table 4, indicating the material needed for different types of reservoirs.)

5. Life expectancy and maintenance demands are other factors to be considered. As the example of rainwater catchment at public buildings in Lobatse (Chapter 1.2) shows, under certain circumstances high construction costs combined with long service life expectancy can pay off. Maintenance, usually a weak point in developing countries, has to be taken into consideration. A decision on the capacity and type of structure to be chosen should take all these factors into consideration.

Attention should also be given to the following questions:

- For which purpose is the rainwater to be used?
- What is the likely monthly consumption of water?
- What amount of water can be harvested?
- What is the rainfall pattern, and how is rainfall distributed during the year?
- Which construction materials are available, which are unavailable?
- How high is the financial amount to be invested?
- By how much can costs of construction be reduced by self-help?

Answers to these questions will lead to a decision on the size and type of reservoir. Compromises must be made on the basis of the answers.

The following Table 3 offers assistance in decision-making. Costs are based on 1985 prices in Botswana where all materials are available.

2.2 Introduction of the different types of reservoirs and their advantages

2.2.1 The corrugated iron tank

2.2.2 The PVC foil tank

2.2.3 The ferro-cement tank without mould

2.2.4 The ferro-cement tank with a factory-made mould

2.2.5 The ferro-cement tank with a made-on-site mould

2.2.6 The reinforced brickwork tank

Although we have learned that the most appropriate type of rainwater reservoir is an economic question, in many cases in developing countries the availability of building materials outweighs the economic factor.

2.2.1 The corrugated iron tank

This is an industrial product manufactured in many countries. Where the material for this tank is available, there are at least three capacity sizes of 2.25, 4.5 and 9.0 m³. Although usually the most economical, prices have to be compared with other suitable materials; the transport aspect can also increase costs substantially. The advantage of this tank is firstly the price, but certainly also the fast installation. The disadvantage is the limited lifetime, although this can be improved as explained in Chapter 4. One should remember at all times that the corrugated iron tank is vulnerable to manual force. Experience has shown that this tank should not be used at public places, especially not at schools, since vandalism is likely to damage the tanks beyond repair.

Type of tank	Construction cost (P per m ³)	Estimated life expectancy (years)	Maintenance	Remarks
Corrugated iron tank	About 70 P decreasing to 55 P with increased capacity	8–15	If used for rainwater only repainting every 5 years. Mixed use depending on the aggressiveness of pipeborne water	Sensitive to external damage, not to be used at public places
Ferro-cement structures	About 50 P decreasing slightly with increased capacity	15–20	Relatively easy repair of damage, replastering after ten years exceptional	Structure must be kept moist
Reinforced bricktank	About 100 P, and above 100 m ³ decreasing to 85 P	30–40	Minimum, replastering after 15 years can become necessary	Plaster must remain moist otherwise leaks occur and replastering is required.

Table 3: Different types of reservoirs

2.2.2 The PVC foil tank

Several industrial producers offer tanks of PVC foil. The foil is fixed inside a reinforcement mesh framework or galvanized sheet cylinders, screwed together from sections. The tanks are available from about 5.0 m³ up to 430 m³. Their considerable advantage lies in fast assembly and low transport costs. A reservoir of 9.25 m diameter (capacity 81.0 m³) can be transported on a small van and be assembled within a couple of hours. No foundation is needed. Dismantling and reassembly at another place can be carried out within a day or two. Apart from this advantage which is very valuable for cases requiring immediate action, for instance improvising a village water supply, the system has some weak points. Tanks of large capacity are uncovered, so evaporation is high and there is a danger of pollution. More important for permanent use is the problem of ultraviolet ray influence on the PVC foil. Systems in use show signs of ultraviolet light effect on the material after just a few years. Otherwise the vulnerability to external force is great and tanks should always be fenced in. For permanent rainwater catchment, although relatively cheap, this technique has its limitations.

2.2.3 The ferro-cement tank without mould

This technique as explained by Laurie F. Childers of UNICEF Regional Office in Nairobi, Kenya, in 1985 has been chosen by the author because of the unique advantages of this appropriate technology. There are many examples of such reservoirs in Kenya.

This technique depends on the availability of welded reinforcement mesh. Since this is not to be found everywhere, other methods can be substituted.

Firstly close attention has to be given to the cost of the material and the transport to the site. Any other material used for this tank is more or less the same as for all ferro-cement tanks. The width of the roll of mesh or mats will be the height of the tank wall, about 1.80 m. This is certainly a restriction. Theoretically, it is possible to extend the height of the wall by using one and a half widths of the mesh, overlapping it on a minimum of three fields and tying it together with the bottom circle, but this is not recommended. The entire structure becomes unstable and any vibration during the process of plastering will make the work very difficult. In addition a scaffold is needed which might not always be available. The fixing of the scaffold requires skilled workers.

2.2.4 The ferro-cement tank with a factory-made mould

The technique was described by N.J. Wilkinson, Botswana Technology Centre in his publication, and was chosen because of the considerable advantage it has for rainwater storage where all tanks are of the same size. Several examples of this are to be found in Botswana.

This construction method can only be chosen if a factory or experienced workshop provides the facilities for bending corrugated sheets and welding them neatly together. The technique is highly appropriate in areas where a series of tanks are to be built. This is the case when new buildings like schools are put up, and the design of the buildings already includes provision for rainwater catchment. In such cases we can talk of a standardized tank.

The mould can be used 10 - 15 times depending on the experience and careful handling of the staff. For larger projects it is advisable to have at least two moulds at the site. The advantage of this construction method lies in the rationalization of the work. The masons become experienced and work can be finished faster. With two moulds, the work can be organized with three crews. The first crew starts preparing the ground and then casts the foundation slab. The second erects the mould and reinforces it, and the third crew does the plastering. The roof slab can be made by a fourth crew or by the first, depending on the amount of ground to be cleared. This technique should not be introduced where only four or five reservoirs have to be constructed; in such a case the mould will

be too expensive.

2.2.5 The ferro-cement tank with a made-on-site mould

E.H Robinson of the American Peace Corps describes this construction technique in the publication. It was tried by "Christian Action for Development in the Caribbean" (CADEC) in the Republic of Grenadines and chosen because of the advantages it offers over other methods.

This technology for constructing reservoirs should be chosen where only a few tanks are required or even just one, in other words where prefabricated moulds are not considered and welded reinforcement mesh is not available. All that is needed, in addition to the normal building materials for a ferro-cement structure, is some additional timber for the framework and a few corrugated iron sheets for shuttering. Fencing mesh is an additional reinforcement but could be replaced by other available mesh material.

2.2.6 The reinforced brickwork tank

These were constructed by the author in Lobatse, Botswana, for public buildings. The reinforced brick tank is more expensive than the ferro-cement tank, although the cost per m³ reduces with increased capacity. It costs about twice as much as a ferro-cement tank. For this reason this tank should be chosen where the capacity needed is above 30 m³ and in all cases where the life of the structure is expected to be 20 years and more. The advantage of the construction method is the adaptability to the building design. Structures above 1.80 m in height are without problems, although plastering has to be done with great care. Especially at public buildings which are usually higher than residential houses, it is possible to use the height between gutter and ground, avoiding large diameters and thus saving space.

2.3 History of ferro-cement

It is often heard that ferro-cement is a poor reinforced concrete and a second-class technology developed for Third World countries. Nothing could be more wrong.

Ferro-cement is a building material with some similarities to reinforced concrete. Indeed, both materials have the same source. Ferro-cement is produced by applying cement mortar composed of fine aggregate and cement onto wire reinforcement using plasterer techniques. As a result the property of ferro-cement distinguishes it from reinforced concrete. While of similar durability, it is more elastic than reinforced concrete.

A Frenchman, Joseph Monier (1823 - 1906), produced flower pots made of cement mortar reinforced with chicken wire and showed this product at the world exhibition held in Paris in 1867. J. Monier became known as the father of reinforced concrete. In Germany for many years reinforcement steel was called "Monier iron". In 1847, another Frenchman, Joseph-Louis Lambot, filed a patent for producing a cement boat, wire-reinforced, not long after the development of Portland cement. Which of the two men first had the idea of combining wire with cement mortar is of no interest. Probably the discovery technique happened by chance. At that time, the commonly known chicken wire was a handmade product and therefore soon too expensive in the fast growing industrial era. But the knowledge of the steel-concrete combination resulted in the development of reinforced concrete using large steel rods. During the First and also later during the Second World War, the technique of Lambot's ferro-cement boat was remembered in the U.S. and the U.K. and shipbuilders were encouraged to construct barges like this in order to save shipbuilding materials such as steel plates and timber. Although some of the boats built during the Second World War had an amazingly long life span, the technique did not really become widespread.

Material	Ferro-cement tank without mould	Ferro-cement tank made with site mould	Ferro-cement tank with factory-made mould	Reinforced brick tank
BRC-welded reinforcement mesh	essential	not essential	essential but can be replaced by rods	essential but can be replaced by rods
Reinforcement rods of different diameter	not essential	essential	not essential	essential
Fencing mesh	not needed	essential	not essential	not needed
16-gauge wire (fencing wire)	essential, substitute barbed wire	essential, substitute barbed wire	essential, substitute barbed wire	not needed
Corrugated iron sheets	not needed	essential for mould	essential for mould	not needed
Binding, tying wire	essential	essential	essential	essential
Chicken wire	essential	essential	essential	not needed
Cement bricks	not needed	not needed	not needed	essential, substitute burnt clay bricks
Portland cement	essential	essential	essential	essential
Coarse aggregate 20 mm	essential	essential	essential	essential
Fine aggregate (river sand)	essential	essential	essential	essential
Factory-made mould	not needed	not needed	essential	not needed
Timber boards and poles for formwork	not needed	essential	essential	essential
Hardboard	not needed	not needed	useful, but can be substituted	useful, but substitute possible
Shutter oil	not needed	needed, substitute used engine oil	needed, substitute used engine oil	needed, substitute used engine oil
Plastic sheets	essential	essential	essential	essential
Material	Ferro-cement tank without mould	Ferro-cement tank made with site mould	Ferro-cement tank with factory-made mould	Reinforced brick tank
Cloths: nylon, sisal, jute	essential	not needed	not needed	not needed
Ladders	essential	essential	essential	essential
Scaffold	not needed	not needed	not needed	essential, above 2.00 m construction height
Sisal string	essential, substitute any other string	not needed, but useful	not needed, but useful	not needed, but useful

Table 4: Major materials needed for different types of reservoirs and possible substitutes

It was the famous Italian engineer and architect, Pier Luigi Nervi, who first undertook real research into ferro-cement technology. He observed that reinforcing concrete with layers of wire mesh resulted in a material with high impact resistance properties. This material differed from reinforced concrete in its flexibility and elasticity. After the Second World War, Nervi built a 165-ton motor sailer. This ship, "Irene", proved to be seaworthy. Similar ships were built in the U.K., New Zealand and Australia, and one circumnavigated the world without problems. But Nervi would not have been a structural engineer and architect if he had not also used this material for building construction. In 1947, he first built a storehouse of ferro-cement. Later he combined reinforced concrete with the ferro-cement technique and constructed the famous Turin Exhibition Hall with a roof system which spans 91 m. Nervi's work proved that ferro-cement is a high quality construction material. The question remains why ferro-cement is relatively seldom used as a building material in industrial countries. The answer lies in the process of industrialization of construction work. In order to minimize the labour cost, construction work has become more and more capital-intensive. As a result, working processes have been mechanized wherever possible. In this context the possibilities for mechanizing ferro-cement remain very limited. A high percentage of labour cost will always characterize this technology. While this is considered to be a disadvantage for industrialized countries, it is a positive factor in developing countries where the labour market is characterized by high unemployment and low labour costs.

It has therefore to be emphasized that ferro-cement is by no means a second-class technology, but rather highly appropriate especially for countries where labour costs are low.

2.4 Calculation of rainwater volume and choice of reservoirs

2.4.1 Reservoir capacity

2.4.2 Roof type and catchment

2.4.3 Roof finish

2.4.4 How to choose the size of a reservoir

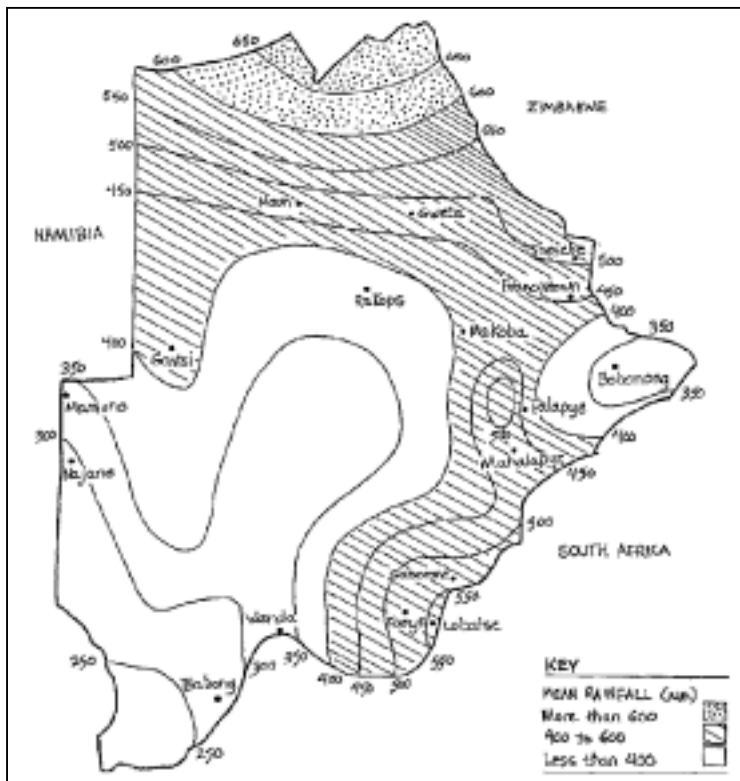

figure 2.1

To calculate the rainwater amount which can be harvested, the mean annual rainfall figure is

commonly used. Mean annual is the statistical average calculated on the basis of measured rainfall over many years. It has to be understood that there is no guarantee that the calculated amount will be achieved, but there is a 95% likelihood that this amount can be expected. This near certainty diminishes to a probability if the rainfall pattern in a given area differs substantially. This is quite common in countries with drought periods. It can happen that the mean annual cannot be expected. It can certainly happen the other way round that considerably more rain falls than the mean annual. This makes the calculation of the storage capacity rather difficult. However, the mean annual is generally accepted as the basis. The size of, storage capacity chosen can be based on the mean annual, but should be greater if funds allow. Some countries provide maps where the mean annual rainfall is indicated along the line of occurrence. Fig. 2.1 shows the rainfall in Botswana; each line is marked with a figure giving the precipitation. The mean annual in a given area between two lines ranges from the lower amount, for instance 400 mm, to the higher average of 450 mm. For example the mean annual rainfall in Gweta is between 450 and 500 mm.

2.4.1 Reservoir capacity

As an example let us consider a roof of 120 m² in an area with mean annual rainfall of 450 mm. We assume that less than 100% of the calculated amount of water will be collected. This is due to unavoidable small leakages in the gutter downpipe system, or rainfalls which are too light to produce sufficient runoff, or a possible overflow of gutters in the case of an extreme downpour. For this reason we can generally assume that only 90% of the rainwater can be collected.

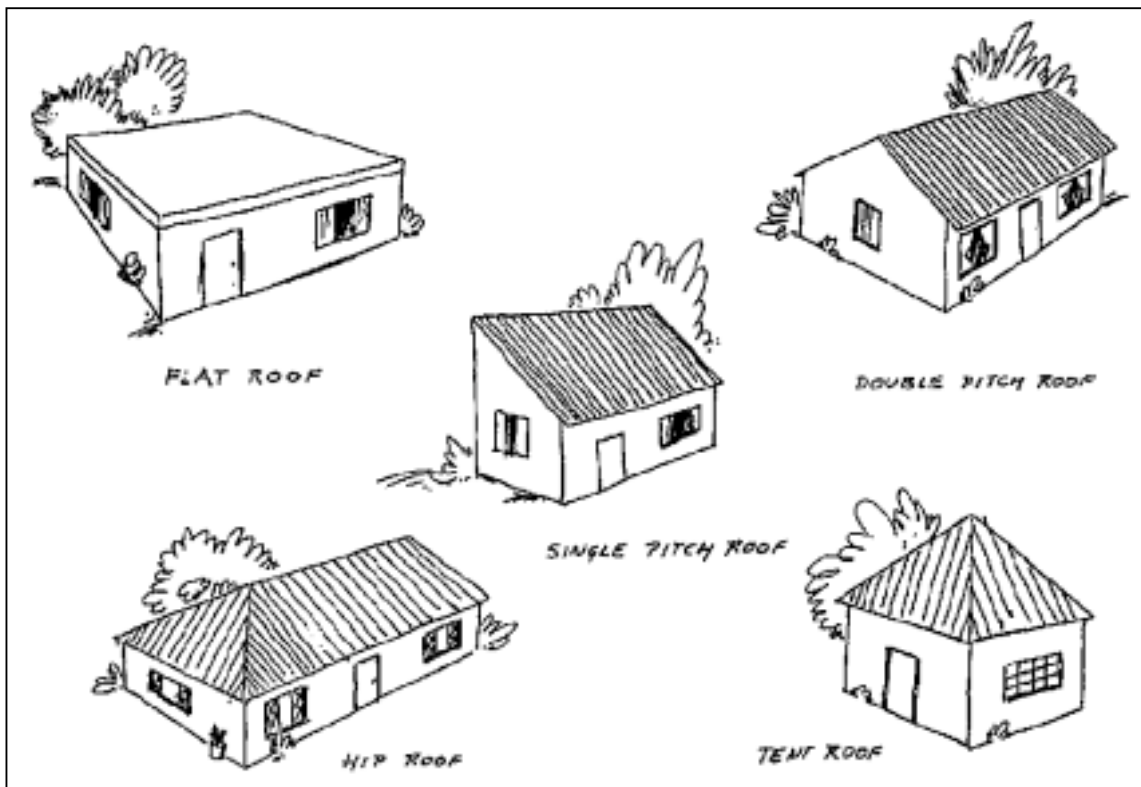

figure 2.2

For calculation we take the following formula:

mean annual rainfall in mm x area in m² x runoff factor = collected rainwater in litres. In our example

this means:

$$450 \times 120 \times 0.9 = 48\,600 \text{ litres.}$$

In most cases it would be unrealistic to consider building a cistern of 48.6 m³ capacity for a house with only 120 m² roof area. However, as the situation differs from place to place, we cannot decide here whether a reservoir of this capacity will be realistic and economically efficient.

2.4.2 Roof type and catchment

The shape of any given catchment area has a considerable influence on the catchment possibilities. Therefore different types of roofs provide different catchment possibilities. Of the most common roof types shown in Fig. 2.2 the single pitch roof is the most appropriate for rainwater harvesting, since the entire roof area can be drained into a single gutter on the lower side and one or two downpipes can be provided depending on the area. A more difficult roof for rainwater catchment is the tent roof. It requires a gutter on each side and at least two downpipes on opposite corners. If a tent roof is large enough, it could be drained into four tanks located at each corner of the house. The main problem is always the corner. A 90° angle in the gutter should be avoided. It is extremely difficult to adjust gutters in such a way that water really flows easily downwards. It seldom works well when downpours occur, and it is the heavy downpours that should be caught. The hip roof is not very efficient either, since it also needs gutters all around the building. Flat roofs can be used for catchment if they are furnished with an edge, keeping the water on the slab until it has drained through the gutter or downpipe. However, using a flat roof for rainwater harvesting is not very efficient because of the extended runoff-time and the evaporation losses. One way to improve the catchment is to provide the slab with a sloping cement screed. Constructing a waterproof edge on a flat roof is rather difficult because of the temperature expansion.

The most useful roofs are the single and double pitch roofs. The double pitch roof offers many advantages. As the picture of Woodhall Community Centre in Lobatse, Botswana, shows, the gutter of the length of one side can be drained into a reservoir on the other side of the building by fixing the downpipe at the gable wall and sloping it towards the cistern.

2.4.3 Roof finish

Not all materials used for roofing finishes are equally good; but the most commonly used material, metal sheeting (corrugated galvanized iron and aluminium sheets), is very suitable for rainwater catchment; likewise, brick tiles of all variations, and also thatch can be used, but these are less efficient.

2.4.4 How to choose the size of a reservoir

Example I {see Fig 2.3}:

A house with a roof area of 9.00 x 6.50 m is to be furnished with catchment and storage facilities. The mean annual rainfall is 450 mm.

Calculation of rainwater:

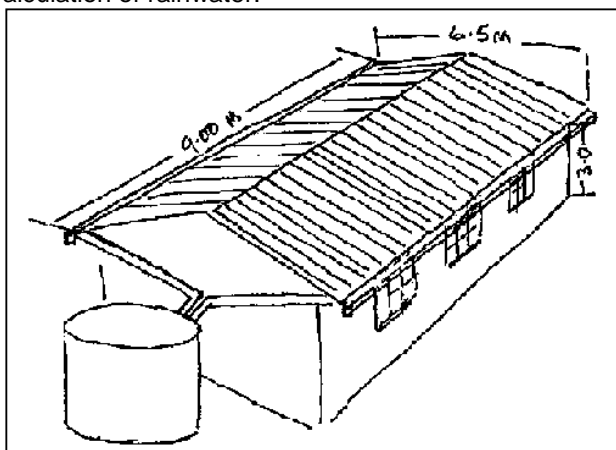

$$9.00 \times 6.50 \times 450 \times 0.9 = 23895 \text{ litres}$$

figure 2.3

The height from the ground to the gutter outlet is 3.00 m. According to Table 5, a reservoir of 4.0 m diameter on a filling height of 1.80 m has a storage capacity of 23 000 litres. This means that one reservoir built at one gable side of the house would be sufficient for nearly all the rainwater which can be collected if an average rainfall occurs. Two gutters along the sides of the building should be connected with downpipes fixed to the gable wall and then bridged into the tank.

For this storage capacity a ferro-cement tank would be more economically efficient than the reinforced brick tank and serves the same purpose. But if a smaller storage capacity would be sufficient, or if funds are very limited, two corrugated iron tanks, each of 9 000 litres, would be cheaper. These two tanks could be located at each of the gable sides, collecting from each gutter, or next to each other on slightly different levels, draining the overflow from the first tank connected to the pipes into the second tank. Fig. 2.4 shows this as an example with two corrugated iron tanks, but the same method is certainly possible with any other type of reservoir.

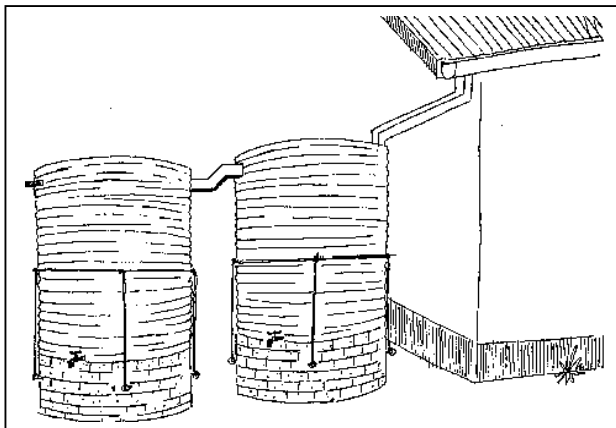

figure 2.4

Example 2 (see Fig. 2.5): Calculation of catchment area:

Roof A:

$$20.0 \times 10.0 \times 450 \times 0.9 = 81000 \text{ litres}$$

Roof B:

$$9.0 \times 15.0 \times 450 \times 0.9 = 54\ 000 \text{ litres}$$

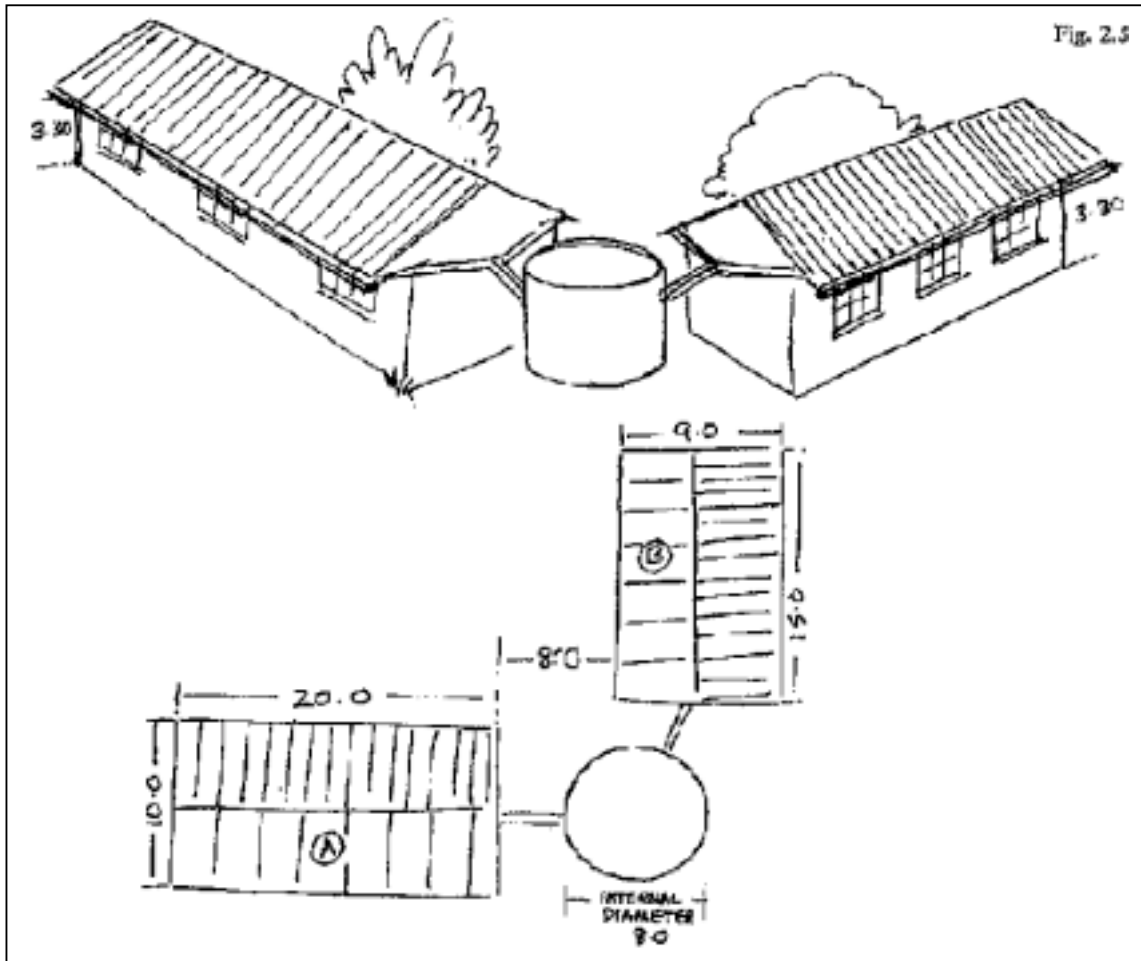

figure 2.5

Total catchment per annum = 135 675 litres. About 136 m³ of rainwater can be caught within a year from 450 mm rainfall.

The size of the chosen reservoir depends on the lowest inflow (see Fig. 2.5) and also on the ground space available. Block B has a gutter height of 3.00 m, Block A height of 3.30 m. The lowest inflow would come from Block B. Since gutters and downpipes must slope towards the inflow, the height has to be calculated. For the gutters a 0.3% slope is the minimum requirement (equivalent to 3 mm per metre). Block A has a gutter length of 20.0 m (20 x 3 = 60 mm), a downpipe with a minimum slope of 10% (10 mm per metre) to the middle of the gable wall 5.0 m, which means another 50 mm for sloping.

We add the 60-mm slope of the gutters to the 50-mm slope of the downpipe resulting in 110 mm and add 15 mm for the distance from the gable wall to the tank inflow, resulting in 125 mm. For imprecise workmanship, measuring faults etc. we assume a total of 200 mm. These 200 mm have to be deducted from the height of 3.00 m between gutter and ground. This final measurement is 2.80 m and indicates the lowest inflow level and at the same time the filling height of the tank assuming that the bottom of the reservoir is level with the ground. The catchment capacity is about 135 000 litres at the most, with a filling height of 2.65 m. Table 5 shows a filling height of 2.65 m. With this filling height, we can build a reservoir with 133 000 litres with an internal diameter of 8.00m.

Internal diameter (m)	Filling height (m)					
	1.80	2.10	2.65	2.90	3.20	3.45
3.5	17.50	20.00	25.50	28.00	31.00	33.00
3.8	20.50	24.00	30.00	33.00	36.50	39.00
4.0	22.50	26.50	33.50	36.42	40.00	43.50
4.3	26.00	30.50	38.50	42.00	46.50	50.00
4.5	28.50	33.50	42.00	46.00	51.00	55.00
4.8	32.50	38.00	48.00	52.50	58.00	62.50
5.0	35.50	41.00	52.00	57.00	63.00	67.50
5.3	22.00	46.50	58.50	64.00	70.50	76.00
5.5	43.00	50.00	63.00	69.00	76.00	82.00
5.8	47.50	55.50	70.00	76.50	84.50	91.00
6.0	51.00	59.50	75.00	82.00	90.50	97.50
6.3	56.00	65.50	82.50	90.50	100.00	107.50
6.5	59.50	69.50	88.00	96.00	106.00	114.50
6.8	65.50	76.00	96.00	105.00	116.00	125.00
7.0	69.00	81.00	102.00	111.50	123.00	133.00
7.3	75.50	88.00	111.00	121.50	134.00	144.50
7.5	79.50	93.00	117.00	128.00	141.50	152.50
7.8	86.00	100.50	126.50	138.50	153.00	165.00
8.0	90.50	105.50	133.00	146.00	161.00	143.50
	Construction height (m)					
	2.00	2.32	2.88	3.12	3.44	3.60

Table 5: Capacity of different tank sizes rounded to the next half m³

This cistern can only be built as a reinforced brick tank. It will be more economical to build one reservoir of this capacity rather than two reservoirs of about 66 000 l, with a filling height of 2.0 m and an internal diameter of 6.5 metres. This example also shows that the correct siting of the building is essential for an economic rainwater reservoir. Taking the theoretical case that the entire rainfall occurs in only 5 days, that would mean that by dividing 135 000 l by 360 days per year, this reservoir would provide 375 litres per day throughout the whole year. Certainly this is theory and in reality the rainfall normally is spread over a period of some months. This also means that some of the collected water will already have been used when the next rain occurs and the reservoir will never be filled up to its maximum capacity, even if the rainfall reaches the annual mean. Or the other way round, since the mean annual rainfall is a statistical measure taken over many years, the chance is greater that an annual rainfall above the average but dispersed over a period of four months will occur and since consumption is constant, even this higher amount of rainwater can be stored.

3. Material testing and mixing

Most of this chapter has been taken from Laurie F. Childers publication on ferro-cement tanks, published by UNICEF Regional Office, Nairobi, Kenya, in 1985. Since the technique introduced is the same as the author has used for waterproof plastering of reinforced bricktanks, it is recommended for all types of ferro-cement tanks and the plastering of bricktanks.

Let us start with some general remarks. The technique for preparing waterproof cement plaster is delicate, not in theory but in practice, because it is influenced by the site conditions. Therefore, it is imperative to first create favourable site conditions for good quality work. This means, for instance, that the place where the mortar is to be mixed is clean, flat, smooth and large enough. If possible, some flat metal sheets should be laid on the ground. If the working ground is only a soil surface, it must be swept like Africans clean their courts. If the soil surface is not hard, it is possible to prepare an area with stamped clay. The working area must be clean before the mixing of the sand and cement can start. Likewise, it is necessary for all material to be on site before the preparation of plaster is started. All material not only means the sand, cement and water for the entire job, but also all curing agents and tools. Tools have to be clean and free of old mortar; this also applies for all buckets to be used. If it is obvious that some sort of scaffold is needed, this has to be there and tried out before the work starts. It must always be remembered that once the plastering of a ferro-cement structure has started, there must be no break until the first coat is finished. The same applies for waterproof plastering of a bricktank. Curing the plaster on the structure is as essential as the right mixture. Organizing the job is also important to achieve smooth hand-in-hand working.

Ignoring this important advice means risking a lot of money and almost certainly creating cracks and leakages. Although smaller faults can be repaired, it must be remembered that a leakage occurs after the reservoir has been filled with water. To repair it means draining the water and usually wasting it. Experience shows that negligence is often found if contractors are employed. The reason lies in the time factor where profit is expected. It is therefore better to stop the work entirely and employ another contractor than to allow an ill-prepared job to start. It should also be realized that leaking or cracking tanks give the whole technology a bad reputation. This is especially important in all those places with no prior experience. Leaking reservoirs can discredit rainwater harvesting. Every finalized cistern construction must immediately be filled with water at least 10 cm high, irrespective of whether it is a bricktank or a ferro-cement structure. This water serves as a long-term curing agent and will keep the plaster moist.

3.1 Sand

The sand to be used for ferro-cement is the same as is used for waterproof cement plaster applied to bricktanks. The sand has to be clean and well graded. This means having grains of many sizes, but 90% should still pass through a mosquito wire sieve. Sand must be clean, because like water it may have some impurities that weaken the cement bond, such as clay, silt and organic matter. Dirty sand can be washed by repeatedly rinsing with water. This should be done on a well-prepared sloping ground by pouring water on the sand while turning it with shovels. The dirt must run off, otherwise the effect is minimized. If sand has to be washed afterwards, it is too wet for ferro-cement plaster and should be given time to dry partly while turning it with shovels three times a day. There are two easy field tests for determining if the sand needs to be washed:

1. Rub a moist handful of sand between your palms. Suitable sand will leave hands only slightly dirty.
2. Fill a clear glass container 100 mm high with sand. Then fill with water. Shake the glass vigorously, place it on level ground and leave undisturbed for one hour. The sand settles immediately and any silt and clay settle as a dense layer on top. This layer is of another colour than the sand, often darker, and should not be more than 6% of the entire thickness of sand (Fig. 3.1). If you have had 100 mm sand, a 6-mm upper layer of silt or clay is acceptable; if it is more, the sand has to be washed.

If sand is not taken at the site but supplied, so-called river sand is likely to meet the quality demanded. Sand has to be stored close to the mixing area on cleared ground. Before the sand can be used for mixing, it has to be sifted. For this purpose a special sieve has to be made out of galvanized gauze wire supported by chicken wire (see Fig. 3.2). The frame of the sieve must be of boards about 100 mm high so that all material which does not pass the sieve remains on top and cannot fall onto the sifted sand. The sieve is to be used by shaking it. Two men hold the sieve, while another shovels sand onto it, not more than three or four shovel fuls at a time. The two men then shake the sieve backwards and forwards. The clean material will fall through the sieve. The rest has to be put aside in such a way that it cannot accidentally be mixed with either of the two piles of sand, the sifted or the unsifted one. Since shaking the sieve is hard work, it has been observed that people start to make mistakes after some time. It should therefore be made clear in advance that the sifting crews are to be changed. Sifting sand and preparing the mixture are just as important as plastering. The final product, the ferro-cement tank or the plaster of the bricktank, depends very much on the care taken by the staff preparing the mixture and in charge of the material.

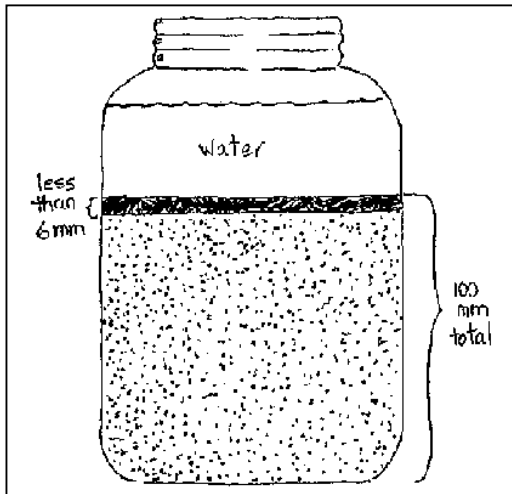

figure 3.1

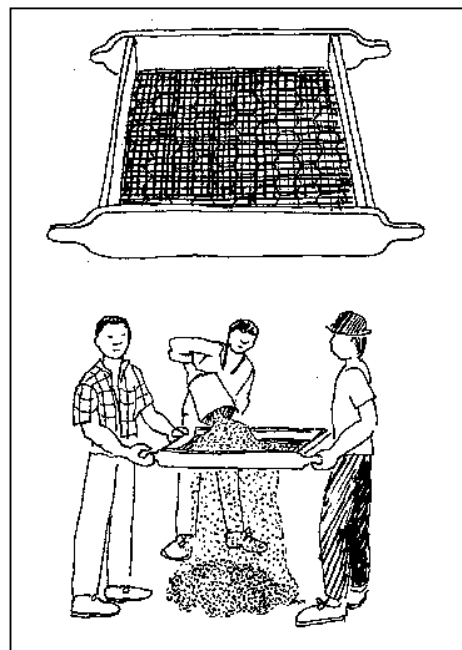

figure 3.2

3.2 Water

Clay, silt, salt, mica or organic matter in the water will weaken concrete and ferro-cement, as will certain invisible chemicals. Water that is fit for drinking is usually fit for mixing cement mortar. The quality of an unknown water can be tested by comparing it with water known to be good. This is best done by using the known water (such as drinking water), making three cakes of cement paste, each approximately 20 mm thick and 60 mm in diameter. At the same time make three identical cakes using the unknown water, and compare setting and hardening times of the two types. The cement paste is prepared like the nil coat, adding cement in a small container with water while constantly stirring the mixture. Cement should not be added fast to avoid clotting or the development of lumps. To achieve equal test cakes, a glass can be used for shaping. All cakes must be of equal size and shape. A chart should be prepared to record the test results (see Fig. 3.3). Mark on your chart that the sample has set when you can no longer make an indentation with your finger tip. Mark the samples with A for drinking water mixture and B for unknown quality. Test for hardening by marking whether or not you can scratch the sample with your fingernail (see Fig. 3.3). The samples must be

stored in the shade. If the chart shows that both samples are nearly equal, the water of unknown quality can be used for mixing cement plaster.

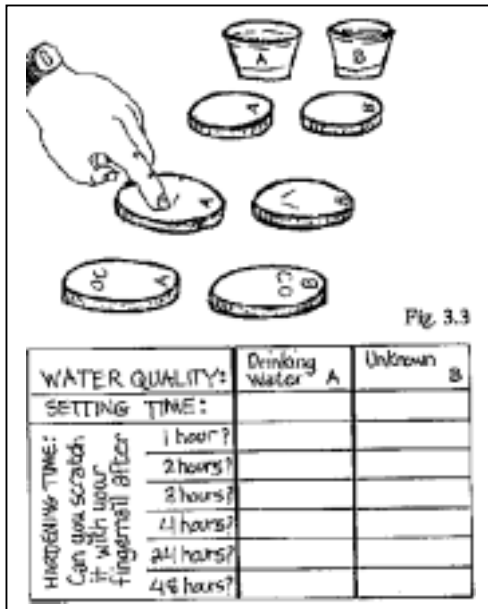

figure 3.3

3.3 Cement

Cement bonds and hardens in the presence of water. Therefore careful storage is imperative to avoid moisture reaching cement before use. The bags of cement should be stored in a closely packed pile, no more than ten bags high. The pile should be on a raised platform in a room with little air circulation. In rooms with open windows and doors, the pile should be covered with plastic sheeting. The same applies if the cement has to be stored outdoors. The platform must be made in such a way that moisture from the ground cannot affect the cement and the plastic sheeting has to be tied so that the wind cannot blow it away and rainwater does not affect the cement. As bagged cement ages and absorbs moisture from the air, it becomes lumpy. If lumpy cement is to be used, its proportion should be increased by half and bigger lumps be removed before mixing.

3.4 Reinforcement

The cement bond is easily broken by forces which pull it apart—tensile stresses. Thus it is necessary to use a material like steel inside the concrete or plaster for large water tanks. The weight of the water will stretch the tank walls. Barbed wire or weld mesh is heavy enough to withstand the stress and hold the tank together. (Straight wire can be used in place of barbed wire, but the barbs help grasp the plaster, and the two twisting wires are stronger than a single wire.) Chicken wire helps hold the plaster together between the stronger wire.

Although the soil helps support the weight of the water, even the ground hemispherical tanks will stretch when full. Hard rocky soils provide better support. Loose or sandy soils should have more reinforcement (barbed wire) in the tanks.

Upright water tanks receive most tensile stresses in the bottom third of the wall and in the joint between the floor and wall. Extra reinforcement wires in the wall and joint and thickening the plaster at the joint prevent cracking at these points of stress.

3.5 Mixing cement plaster

The correct method of measuring the different aggregates of concrete or cement mortar is to weigh them. But this is not possible at most sites. The common way is to measure the volume. Although this is not a precise method, it is efficient enough if performed carefully. Measuring by the shovelful is not acceptable since this is too inaccurate. Measuring must be done with buckets or wooden boxes, all of equal size. A 1:3 mixture means three measurements of sifted sand to one measurement of cement. These two dry components have to be mixed (see Fig. 3.4) by shovelling a pile of sand with the required amount of cement added from one side of the mixing platform to the other and then back. This procedure has to be repeated 4-6 times until the dry mixture is of equal colour. Before adding water, prepare another pile of dry mixture. A second pile of dry mixture should always be ready before water is added to the first pile. This gives a certain guarantee that there will be no interruption of the supply of mortar for the plasterers.

Water must be added very carefully. It is appropriate to make a test of a small amount first and let the plasterer try to work it. The mortar for ferro-cement must be moist, not wet. If you can take it in your hand and shape a ball without water running through your fingers, this indicates the right consistency. Water should never be visible in the mixture and the mortar should not look shiny. For waterproof plaster on brick tanks, the mortar is slightly wetter, but here, as with ferro-cement, the same problem occurs if too much water is added. In this case the mortar slides on the underground where it settles and horizontal cracks appear. The cracks indicate that the mortar is no longer homogeneous. Work should stop until proper mortar is supplied. The content of water in the mixture is a most sensitive issue. It is called water-cement ratio. For easy understanding it should be realized that where water is, no other material can be. But since water will eventually run off, it will contain cement. The structure will be weakened if too much water is added. It can be said that only 10% more water than necessary to make the plaster workable will reduce the strength of the plaster by 15%. If 50% more water is added, the plaster will lose 50% of its strength. The same applies for concrete, although it can be observed everywhere that concrete is considered to be good and workable if it runs out of the wheelbarrow. This consistency is wrong and creates a weaker concrete.

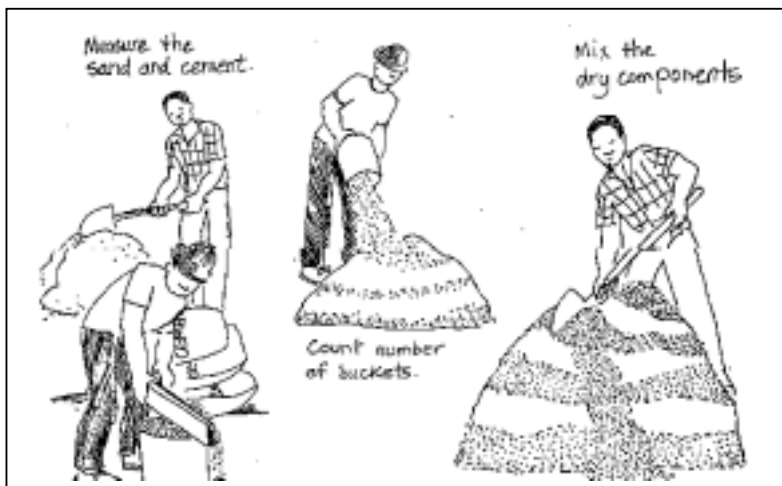

figure 3.4

3.6 Curing

Therefore it must be realized that as little water as possible should be used for mixing, but the use of water should be generous for curing. It is not commonly known that cement plaster, ferro-cement and concrete have to be kept wet for at least 28 days, never being allowed to dry since the process of hardening will stop as soon as the mortar/ concrete dries. If, as in our case, waterproof plaster

has to be achieved, the material must be kept wet for one year. But even after a year cement plaster should not be allowed to dry off. Remember curing is as important as material testing and mixing the right composition of mortar or concrete. The chart gives an indication of how important curing is.

The cured cement plaster achieved the following hardening results:

After 3 days	20% of final hardness
After 7 days	45% of final hardness
After 28 days	60% of final hardness
After 3 months	85% of final hardness
After 6 months	95% of final hardness
After 1 year	100% of final hardness

4. Installation of a corrugated iron tank

When you order a corrugated galvanized iron tank, ask for the measurements or find one from which you can take the measurement. The height between the gutter outlet (where the downpipe is connected) and the ground is your clear height. If the tank is 2.20 m high and you have 3.00 m clear height, prepare to build a plinth about 0.5 m above ground. If you can make a higher plinth, remember the advantage in case you want to connect a hose to distribute the water on a vegetable field. Pressure will be higher if the tank is elevated as high as possible.

If the tank is supplied before you could build the plinth, make sure the tank is stored safely. The larger the tank, the more it is affected by storms. More than once, a tank not properly stored has been blown away by storms and as a result badly damaged. The supplier only has to guarantee safe transport with loading and unloading. Check the tank for damage.

The plinth can easily be built of cement blocks. If they are hollow blocks use them upside down and fill the chambers of every course with concrete. Remove the topsoil on an area of slightly larger diameter than the tank and build a circular wall as high as needed (see Fig. 4.1). Place four steel anchors into the joint of the first or second course of the blockwork in such a way that they are opposite each other in pairs. This means one anchor at each quarter point of the circumference. They are used to fasten the tank with a steel rope. The space inside the circular wall should be filled with soil or gravel and be well compacted. Waste material is usually not suitable since it is very difficult to compact. Compaction should be done mechanically in layers not exceeding 300 mm, see Fig. 4.2. If possible the filled-up plinth should be compacted by water as well. Only after the filling is very well compacted should a concrete layer not less than 50 mm be applied. The top of the concrete must be flat, level and smooth.

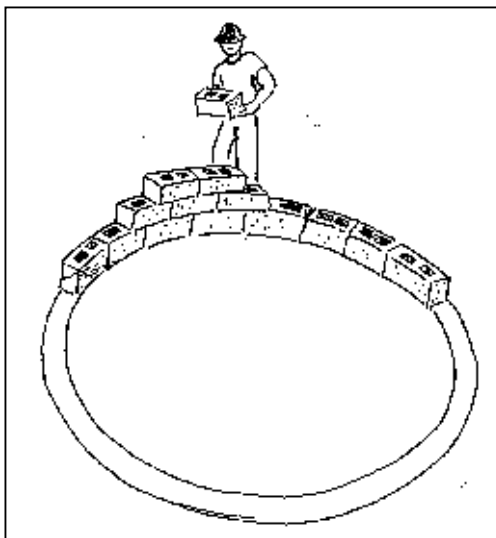

figure 4.1

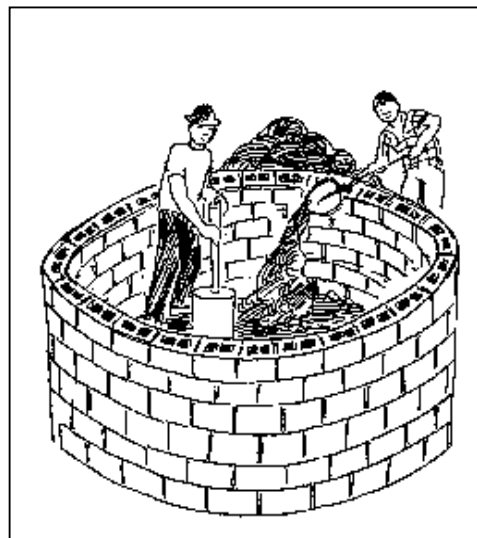

figure 4.2

It is common but not recommended to put the tank on top of the plinth. The problem is that after the tank is filled with water, occasionally depending on the difference in temperature between the water and the concrete plinth, condensation water will develop between the bottom of the tank and the concrete slab. This condensation water cannot evaporate easily because of the tied joint between tank and slab. Over the years, this water will cause corrosion to the tank's bottom. This can be avoided if a layer of 20-mm timber boards is placed on top of the plinth (see Fig. 4.3), before the tank is fixed in position. The advantage of this is double. Firstly, the timber will hinder the development of condensation and therefore this will occur less often. Secondly, if condensation

develops because of high humidity and air temperature but low temperature of the water tank, this condensation can easily evaporate through gaps between the timber boards which allow ventilation. Another advantage of this layer of timber is that it is a relatively soft material and will act as a buffer between the hard concrete and the hard but very thin tank bottom. The timber must be treated.

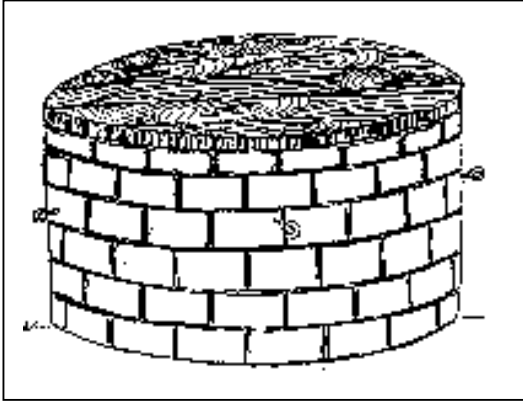

figure 4.3

The interior of corrugated iron tanks should always be painted with special water tank paint. This paint, usually black, is produced on a bitumen basis. The manufacturer indicates that the paint does not affect drinking water. Since most of these types of paints develop toxic fumes, painting inside the tank can only be done with breathing masks, but these are often not available. Another method is to pour paint into the horizontal tank through the inspection hole and to spread it by rolling the tank carefully. This protection paint reduces the corrosion of the metal from the inside and, by doing so, extends the life of the tank. The paint should also be used for the outside bottom of the tank and especially the soldered joints between bottom and corrugated tank wall covering, as well as two corrugations, before the tank is put up.

Every corrugated iron tank must be fixed in position with steel ropes or heavy 16-gauge fence wire. The larger the tank the greater the risk of storm damage if the tank is empty and not tied down to the plinth (see Fig. 4.4). A tank supplied by two gutters is shown in Fig. 4.5.

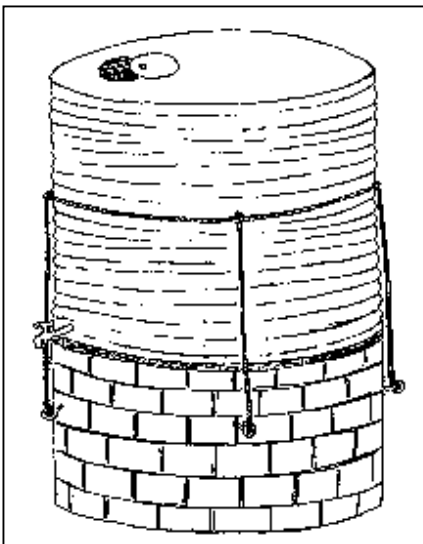

figure 4.4

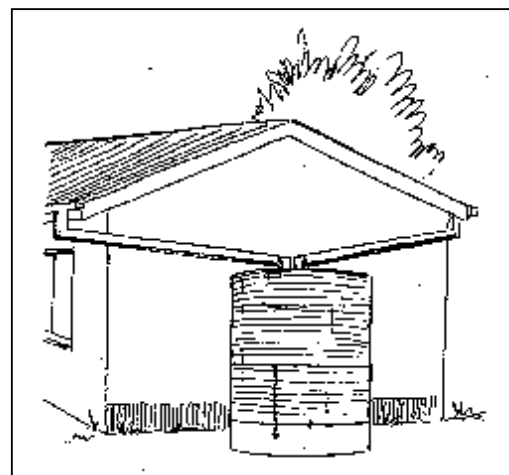

figure 4.5

If a corrugated iron tank is used not only for rainwater but also for raw water from boreholes or wells,

and if this water is considered to be contaminated, try to find out whether the contamination is caused by minerals. Water with a high content of salt or manganese accelerates the process of corrosion. Tanks used for corrosive water should be repainted at least every five years.

5. Construction of ferro-cement reservoirs

5.1 Reservoir without mould¹

5.1.1 Preparation of ground

5.1.2 Preparation of reinforcement

5.1.3 Preparation of the floor

5.1.4 Preparing the wall reinforcement

5.1.5 Preparation of the tank roof reinforcement

5.1.6 Further procedure on the tank wall

5.1.7 Plastering the tank from the inside

5.1.8 Preparing the roof reinforcement

5.1.1 Preparation of ground

Choose the tank capacity according to Chapter 2.4. Determine the location of the proposed tank taking all facts into consideration to achieve maximum catchment capability.

Prepare the ground. Remove all garbage and scraps from the area where you intend to work, as well as loose stones, bricks, and smaller rocks. Check whether the chosen area is level. If you don't have a straight timber board to extend the spirit level, make yourself a simple level instrument as shown in Fig. 5.1. Take three timber boards, straight and if possible edge-shot. Fit the boards together in a rectangular triangle. This means the two short sides have to be equally long (example: $a = 1.42\text{m}$, $b = 2.00\text{m}$). Mark the centre, exactly half of the long side of the triangle. Fix a plumb-line in the centre of the right angle. If you turn this up with the long side on the ground, the plumb must be on your centre mark. If this is the case, the ground is level.

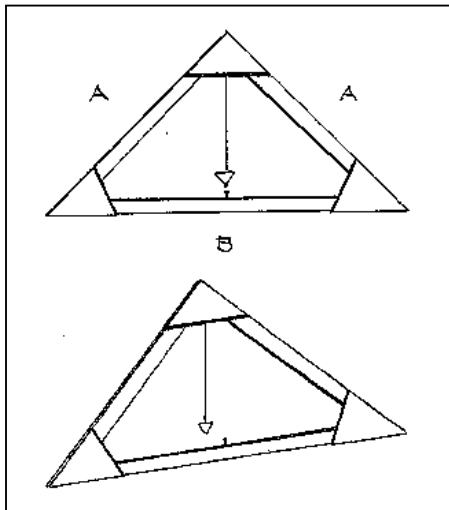

figure 5.1

The height of the wall depends on the size of the reinforcement mesh. If this exceeds 1.80 m, the wall should not be higher than 1.95 m.

On the levelled ground mark the foundation slab circle by dividing the size given in Table 6 by two. To mark out the circle use a string and two sticks as shown in Fig. 5.2.

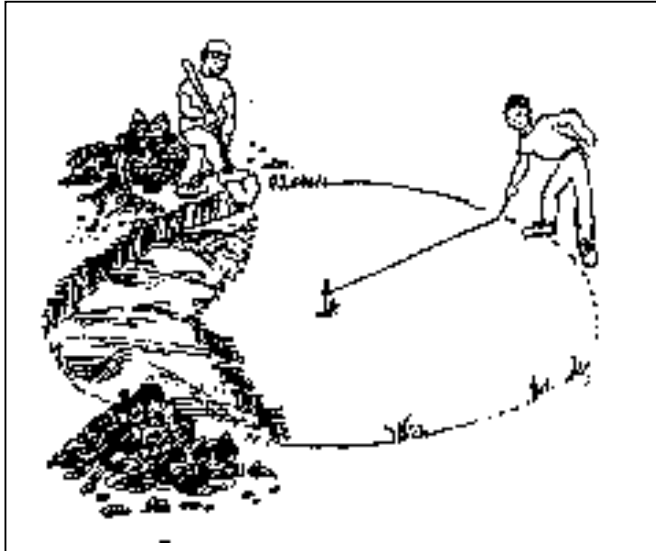

figure 5.2

Dimensions	Capacity		
	10 m ³	20 m ³	30 m ³
Internal diameter	2.66 m	3.76 m	4.60 m
Foundation slab diameter	3.02 m	4.10 m	4.95 m
Diameter of the mesh circle	2.72 m	3.82 m	4.66 m
External diameter	2.76 m	3.86 m	4.70 m
Height of the structure	1.80 m	1.80 m	1.80 m
Level of overflow			
Level of inflow	1.65 m	1.65 m	1.65 m
Mesh circumference including 30 cm overlap	8.85 m	12.30 m	14.94 m

Table 6: Dimensions for ferro-cement tanks

Within the circle remove all topsoil (vegetable soil). If the depth of this layer is more than 100 mm, you have to refill with hardcore. Note no foundation should be made on topsoil. Refilling is also required if only part of the marked-out area has a deeper layer of topsoil. The refill must be compacted by pile-driving. It also helps to fill water on top of the compacted refill overnight and pile-drive the next day. The same is required if the soil is very sandy. See also Chapter 5.2.

Note: The structure of the tank can crack if it is built on unstable ground. Any structure is as strong as its foundation and the ground founded on.

Item of material	Size of ferro-cement tank		
	10 m ³	20 m ³	30 m ³
Portland cement (bags)	28	46	68
BRC weld mesh 6" × 6"			
mesh 7' × 150' roll N° 65 or 66 (m)	20	30	40
3 × 100' chicken wire 1" mesh (rolls)	1.0	2.0	2.5
Binding wire 16-gauge (kg)	6	10	13
Clean sand (m ³)	1.5	2.5	3.0
Aggregate dia. 20 for concrete (m ³)	0.8	1.3	2.0
Water tap unit	1	1	1

Table 7: Schedule of material consumption

If the most suitable place chosen is on sloping ground, you first have to level this area. Dig out an area which is between 1.00 and 1.50 m larger than the diameter of the foundation slab. Make sure the area is really on level ground. Before digging the tank foundation, save the sloping ground from sliding (see Fig. 5.3).

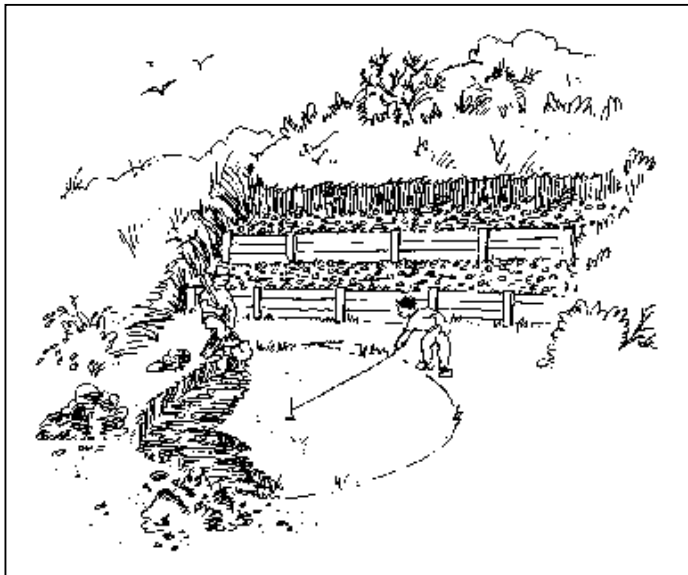

figure 5.3

This can be done by stepping the slope behind the proposed tank. The raiser can be made out of wooden poles rammed into the ground and horizontally saved by either round poles or boards fixed to the rammed poles. The wood should be treated. The cheapest way is to dip it in old engine oil and dry it in the sun before use. The steps should not be filled up with soil but with solid material like small rocks, bricks and similar objects. This is the place where leftover material like cement mortar should be poured in later. The soil above the steps should be saved by planting bushes. Proceed with the foundation as described. If the ground is rocky, remove the soil between the different rocks as much as possible, together with loose rocks. Fill up the gaps between the rocks with lean-mixed concrete, cover the area with empty cement bags and water them for at least three days, keeping the bags constantly wet.

5.1.2 Preparation of reinforcement

On a flat area near the proposed tank, mark another circle with the radius of the foundation, then cut off pieces of reinforcement mesh as shown in Fig. 5.4, laying them out on the circle as shown. Trim off the corners lying outside the circle and save the pieces. Reinforcement mesh can easily be cut in a number of ways. The most efficient is to place a hard stone or large hammer or mattock beneath the reinforcement wire and then cut it using an old chisel and hammer or a panga. Cut another piece of reinforcement mesh from the roll and lay it over the remaining part of the circle. Make sure the overlap between the two pieces is at least one full square. Again trim and save the pieces outside the circle. Tie the two pieces together with short pieces of binding wire, Fig. 5.5. If there is still one final portion of the circle not yet covered with reinforcement mesh, this should be filled by tying the remaining corner pieces (cut earlier). Again make sure all overlaps are one full square as a minimum. The floor reinforcement is now complete.

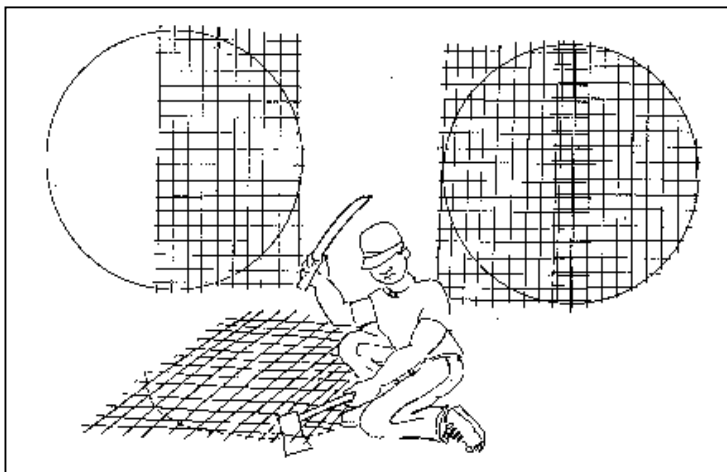

figure 5.4

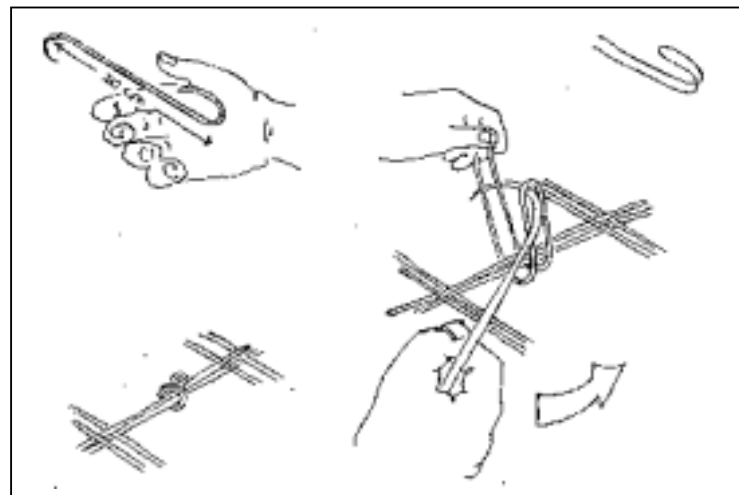

figure 5.5

For other technical solutions for reinforcing the foundation slab on unstable ground, see Chapter 5.2.

5.1.3 Preparation of the floor

Mix a part of cement with one part of sand and two parts of gravel (aggregate dia. 20). Check the material as described in Chapter 3 and follow the advice given there. Mix the entire amount dry, that means without water, until the colour is uniform and you can trace the cement on each shovel of material. Now add water carefully to make the mixture workable. This means the entire mixture should become moist. If your mixture flows off the shovel or even separates into material and water, your concrete is far too wet. This will result in the cement penetrating the ground together with the water. At the same time your mixture contains less cement than required. In general it can be said that concrete which is easy to work with is too wet. Working with concrete requires strength and good care. Clean a wheelbarrow of all the leftovers of formerly used concrete and transport the ready concrete to the tank floor area. On the well levelled 100-mm-deep area, fill in a layer of 50 mm. Level it as shown in Fig. 5.6 and compact it. Remember if the concrete does not need any compaction it is too wet.

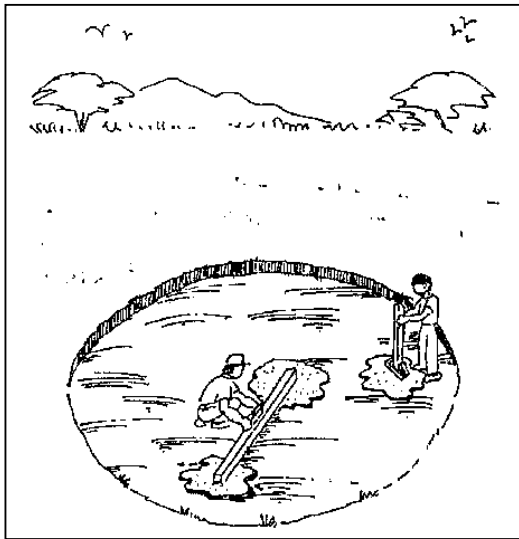

figure 5.6

When the whole excavated foundation pit (floor) is covered with a well-compacted layer of 50 mm concrete, place the prepared reinforcement onto it. Mix the same amount of concrete as for the first layer. When you prepare the second layer keep a ring of 400 mm from the edge of the circle open, without concrete. Compact the concrete as you did for the first layer, see Fig. 5.7.

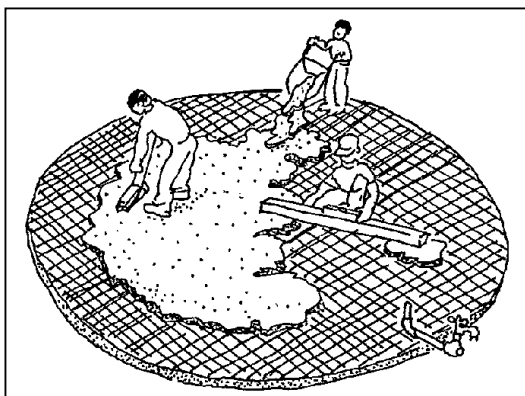

figure 5.7

Take your prefabricated draining pipe (tap unit), consisting of two elbows, one tee, three pieces of 3/4 inch pipe, and the tap. Stuff some paper into the open end of the pipe to keep cement out and fix

this part at that side of the floor where you want to tap water. Tie the pipe to the reinforcement to make sure it is fixed in position (see Fig. 5.8).

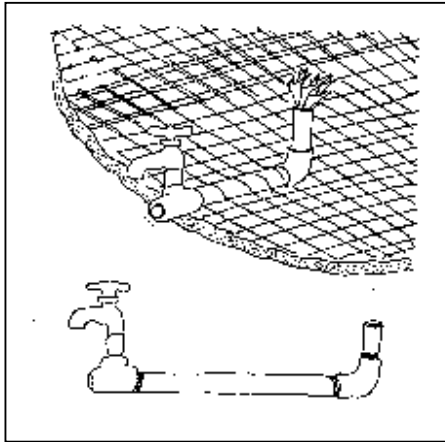

figure 5.8

5.1.4 Preparing the wall reinforcement

Find the length of reinforcement mesh in Table 7 under BRC mesh. Cut the right amount of material from your roll and form into a cylinder with an overlap of two squares' minimum 300 mm. Tie the overlap together with binding wire as done with floor reinforcement (see Fig. 5.9).

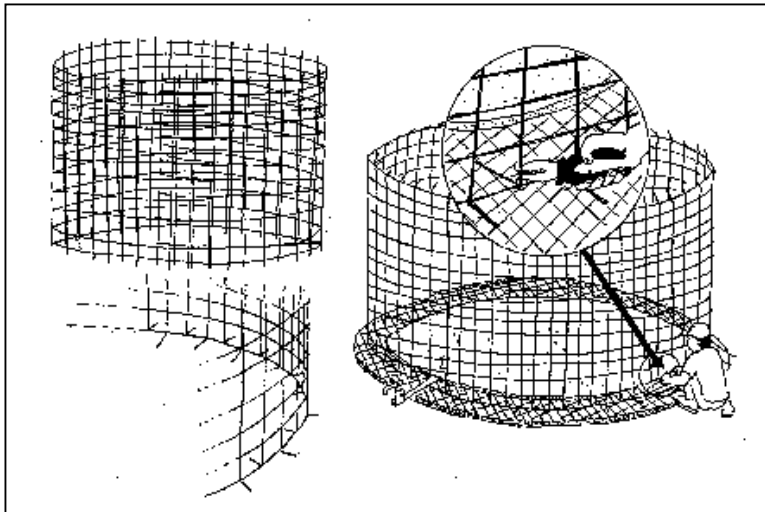

figure 5.9

At the bottom of the cylinder made out of reinforcement mesh, bend the vertical wire segments horizontally. Bend them alternately inwards and outwards, forming right angles. Move the cylinder onto the floor of the proposed tank and tie it to the floor reinforcement. Make sure the vertical mesh forms a cylinder in good circular shape. This is achieved if the vertical reinforcement is at the same distance to the external floor circle (Fig. 5.9).

Now use the last remaining concrete, filling in the space underneath the wall inside and outside the wall reinforcement. Stamp the concrete down carefully and firmly. After this work is finished, cover the floor and the edge outside with plastic, see Fig. 5.10, and keep it covered overnight. Do not work on the wall reinforcement. Next morning remove the cover and splash the concrete all over with water. This- must be repeated every three hours throughout the day and throughout the entire job, at least four times a day. Remember the strength of the concrete depends on good watering during the

construction period. Evaporation of the moisture contained in the concrete should be avoided since it is needed for the setting process. The water you splash on the concrete will evaporate and at the same time keep the concrete moist.

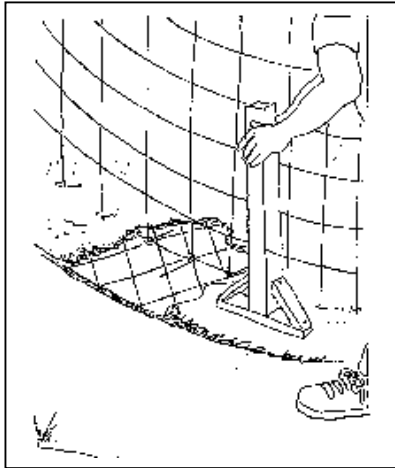

figure 5.10

5.1.5 Preparation of the tank roof reinforcement

Mark a circle in your preparation area with the radius of the tank reinforcement. Put an upright cement block in the centre about 450 mm high. There are different ways of cutting the reinforcement mesh. The roof has to be a dome shape, so the cement block marks the highest point. Make sure an overlap of at least two squares, about 300 mm, is given and tie the reinforcement well together. Whether this has been achieved can be proved by lifting up the dome. It should be well stabilized in one piece. Fig. 5.11 shows one way of cutting the reinforcement mesh to save material. After all triangles extending the circle are cut off, cover the dome of rein" forcement mesh with chicken wire and tie it well to the mesh. Overlapping of the chicken wire is important. 200 mm is required, Fig. 5.12.

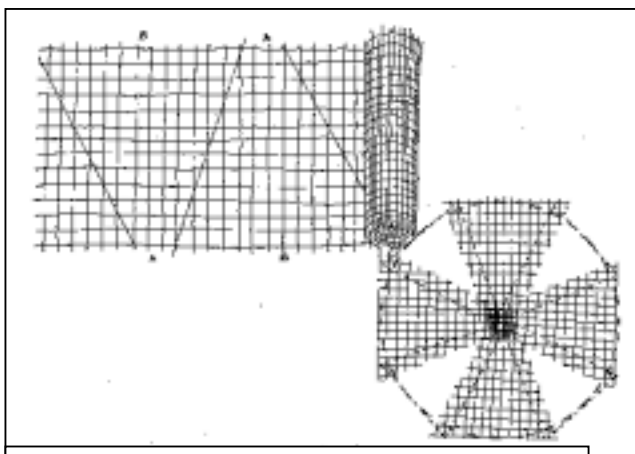

figure 5.11

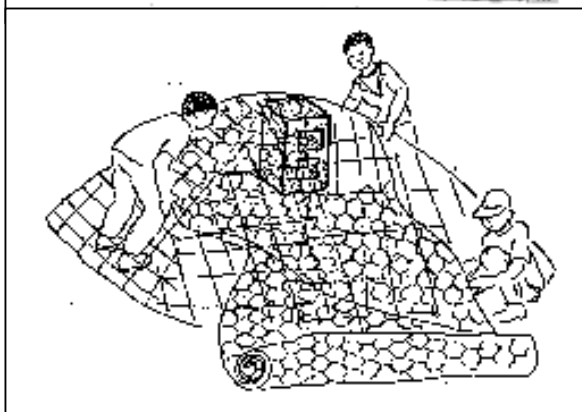

figure 5.12

5.1.6 Further procedure on the tank wall

First prepare some spreaders out of wood and fix them in the upper third part between the reinforcement mesh. This will prevent vibration and bending during the further work on the wall. The next step is to wrap the outside of the wall reinforcement mesh with one layer of chicken wire, from the uppermost horizontal wire to the concrete floor. Take the roll of chicken wire and push the top long edge over the free vertical mesh. While continuing to encircle the cylinder, keep pulling the chicken wire tight in both vertical and horizontal directions, Fig. 5.13. Try to do this job with three people, one carrying the roll and pulling the wire, one fixing it with prepared short pieces of binding wire on the mesh, and the third assisting him in pulling the chicken wire tightly into position. Overlap the two ends of the chicken wire by 200 mm and fasten it. The chicken wire has to cover the entire wall reinforcement. Depending on the size of the roll of wire and the height of the tank wall reinforcement, it might require three or more layers. It is imperative that each layer overlaps the other by at least 200 mm.

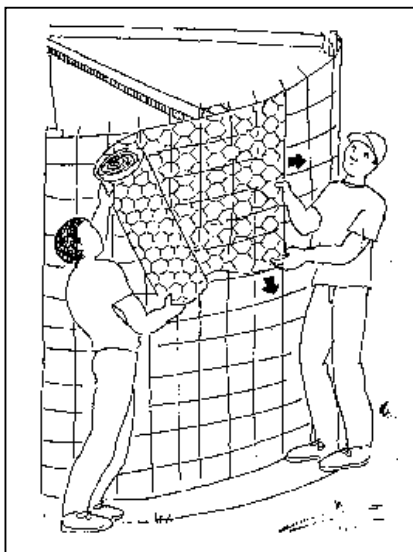

figure 5.13

After the chicken wire wrapping is completed and all sags and bulges are tightened up, take a roll of 16-gauge binding wire and wrap it four times around the top horizontal. This helps to support the roof. Then proceed to spiral the binding wire down every 100 mm for the next 600 mm of wall height, pulling it very tight. After you have completed wrapping the next 600 mm downwards, reduce the intervals between wraps to 80 mm for the 600 mm or more, but make sure the bottom 700 mm have an interval of only 50 mm. At the very bottom do the same as at the top, and wrap the wire round four times. It is most important that the wrapping of reinforcement with binding wire be done by pulling it with force and fixing the ends very tightly. If your roll of wire ends before the wall reinforcement is wrapped, tie the end around a vertical reinforcement wire of the mesh, using pliers,

Fig. 5.14.

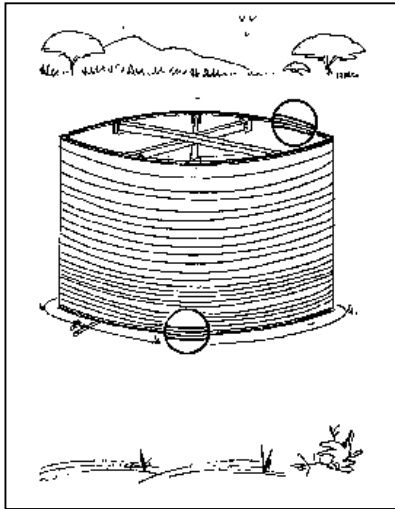

figure 5.14

Now the reinforcement of the wall is ready. It must be lined with cloth from the outside to hold the plaster which will be smeared on the reinforcement from the inside. The material you choose for this will be determined by availability. Clean sacks can be cut in straight pieces and sewn together. If you can get sugar sacks made of nylon, this will be best but jute sacks or sisal material are also suitable. The nylon sugar sacks have proved to be very good. Fix the cloth temporarily at the reinforcement, overlapping by about 50 mm. Then take a roll of sisal string and wrap the cloth from top to bottom at intervals of 50 mm in the same way you tied the gauge wire, but using a uniform interval all over, Fig. 5.15.

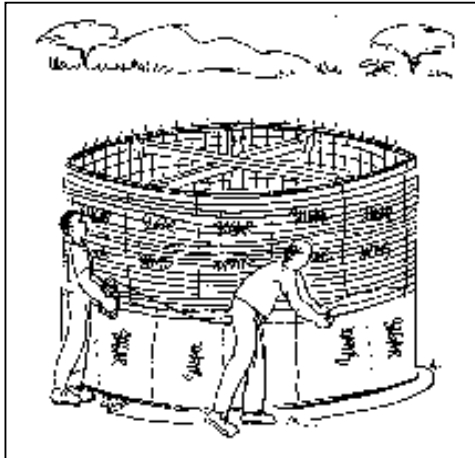

figure 5.15

After the tank is entirely wrapped, make sure there is no gap where the reinforcement is visible. Prepare a scaffold to bridge the wall without touching it. Remember all the plaster has to be transported via this scaffold and during all this procedure the wall will be protected from vibrations. Inside there should be enough space between the scaffold and the wall to allow one man to plaster it. In case material for stable scaffolding is not available, fix two ladders together at the top as shown in Fig. 5.16. Outside they should be spread to prevent transmitting vibrations to the wall. Remove the stabilization spreading from inside. Now it may be necessary to adjust the wall to make it stand straight and in a good circle. The foreman climbs the ladder or scaffold and inspects the shape. Where it is not in good cylindrical form, adjustments are made by fastening lengths of binding wire to the reinforcement mesh. Pull the wire with just the right strength to remove any sags or bulges (see Fig. 5.16). The next step is the preparation and mixing of the plaster, see Chapter 3.

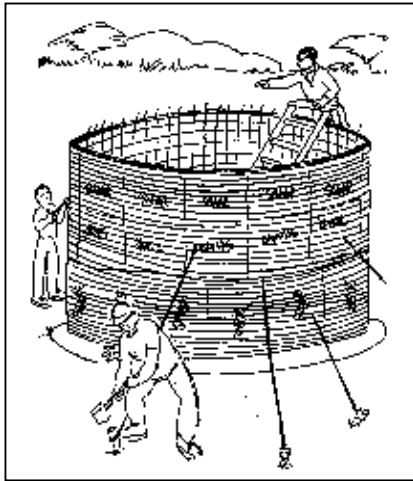

figure 5.16

5.1.7 Plastering the tank from the inside

Before you start plastering, remember that the entire first coat of the tank must be plastered in one day. It is not possible to keep the unfinished plaster overnight. Where the one-day-old plaster is joined with the fresh plaster, leaking will occur. Make sure you have enough labour for mixing the plaster and carrying it to the plasterers. If necessary have two plasterers and start on two opposite sides of the tank wall. Push or smear the plaster onto the wires from the inside of the tank. Starting at the bottom, no plaster should leak through the outside cover cloth. Plaster in this way until you reach the top horizontal reinforcement wire. However, leave two squares empty at the top underneath the future roof for construction of the overflow, Fig. 5.17. After the plastering is finished, hang plastic sheets from the top to the bottom to cover the inside plaster. The plastic should overlap and be protected against blowing away by the wind. This can be achieved by fixing sisal strings at the bent formerly vertical wires of the reinforcement mesh, and weighting them with bricks or stones at the end above the floor. If the outside cover material is nylon, no further action need be taken. In the case of sisal, just splash water on it until you leave the site in the evening. This material must be kept wet to prevent the plaster from drying out. Don't forget to keep splashing water on the floor; the floor concrete should never become dry.

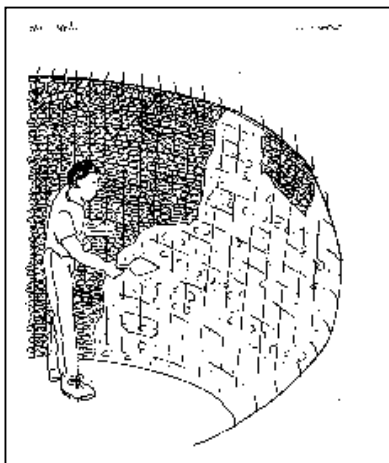

figure 5.17

Only remove the plastic cover the day after you have plastered the inside of the tank. Start the second coat by throwing plaster evenly. The plaster can be a slightly wetter mixture than you used the day before, but it should not be shiny. Remember that the wall thickness when finished is only 50 mm, 30 mm of which are on the inside. Fill up the sags and level them with the bulges. Finish with a wooden float. Work with two plasterers and finish the job in one

operation, see Fig. 5.18. After you have finished, cover the inside again with plastic like you did the day before.



figure 5.18

Now remove the cloth from the outside and start plastering as for the inside, but not more than 10 mm thick. Fill the sags and level them with the bulges, Fig. 5.19. Do not float. Allow the plaster to set (about 1-2 hours). After this job is finished, which can be done simultaneously with the inside plaster levelling, Fig. 5.18, cover the wall outside as well as inside again with plastic and keep covered for at least one night. Make sure the plastic cannot be blown away. Secure it with sisal string and stones as indicated above.



figure 5.19

The following day remove the plastic from the outside first. Throw on a light coat of plaster about 10 mm thick. Then smooth it with a wooden float until the entire outside is a smooth plumb wall. During outside plastering, prepare the overflow. Choose the place carefully. Under no circumstances should the overflow be at the same side as the tap. It is advisable to locate the overflow at a side where a slope (even a slight one) directs the flow-off away from the tank. Make sure the water does not flow towards the house. With a hacksaw, cut the horizontal wires of the reinforcement mesh. The size of the opening should be slightly larger than the downpipe filling the tank. Bend down the piece of wall and wrap with several pieces of chicken wire. Place a flat board under the overflow and use one or two posts to support it. Plaster the top and smooth it. With the plaster form a gutter-shape, round or squared, whichever is easier. Do not cut through the top wires. This reinforcement is needed to keep the circle together, Fig. 5.20.

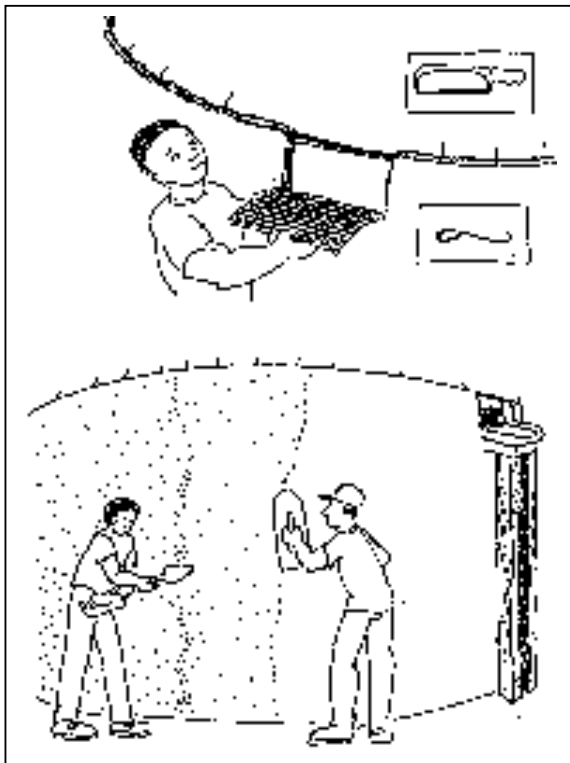
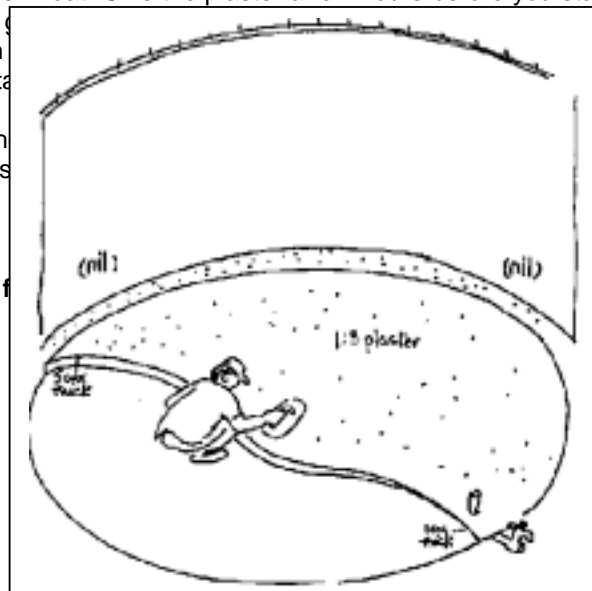
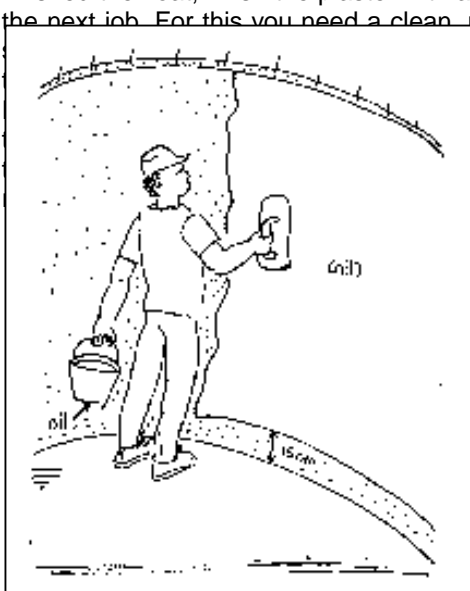

figure 5.20

Remove the plastic foil from the inside wall and prepare the nil. If possible, the nil coat should be applied on the wooden - float-finished plaster from inside on the same day you plaster. If this is not possible, the wall must be splashed with water before applying the nil. Mix pure cement with water until you have a thick soupy consistency. This is achieved by nearly equal parts of cement and water. Stir until smooth and free of lumps. This is done most easily by adding cement to the water, in small portions, while stirring constantly, not the other way around. The mixture is called nil. Use a steel rectangular trowel and smooth it very evenly onto the new plaster. If the nil is still too thin, add more cement. Leave a 100 mm strip around the bottom of the wall free of nil. These 100 mm should be marked first to make sure you always meet the right height, Fig. 5.21. After the nil is finalized, cover the wall again with plastic, clean the concrete floor of all leftover mortar, and splash with water to keep it wet. Next day, prepare the same 1:3 mixture as specified for plastering the floor. There should be no dust or loose material left on the concrete floor. The plaster is to slope towards the outflow. You should start on the opposite side with a thickness of about 40 mm and slope down towards the outflow, reducing the thickness to not less than 15 mm, Fig. 5.22. After you have finished the float, finish the plaster with a wooden float. Give the plaster a few hours before you start the next job. For this you need a clean round



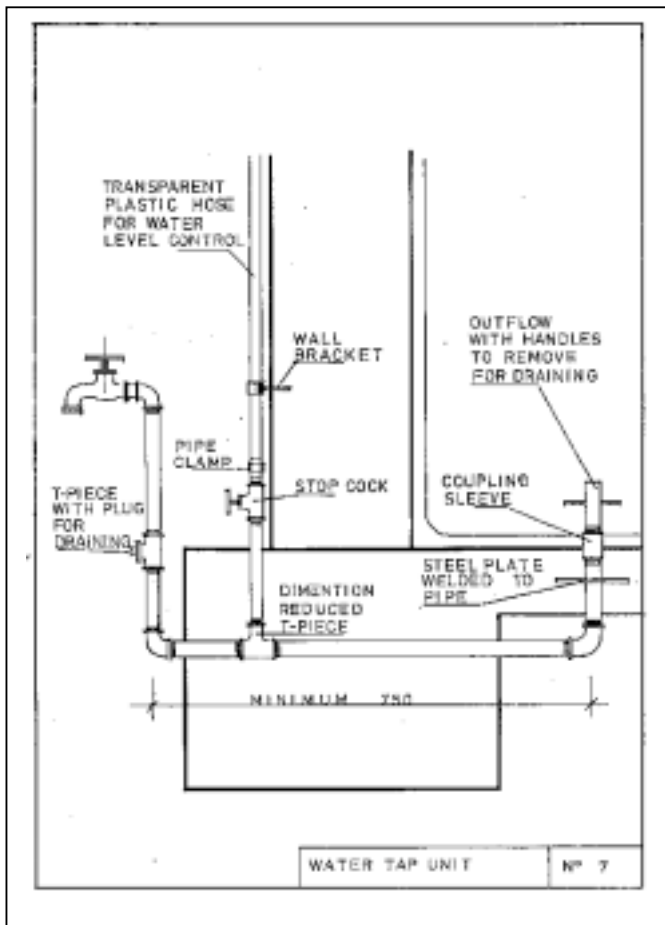

figure 5.23

After you have shaped the corner remove the rest of the plaster carefully from the floor. Working in steps of about 2 m, move round the tank until you reach the starting point. From here you start again, this time with the nil coat. If the plaster is still too wet, wait for a while. This is an important operation and has to be done very carefully, since this part of the tank sometimes leaks. After the corner all around the tank is neatly shaped and covered with nil coat, pour water onto the floor slab. The nil coat for the floor is not to be done before the roof is finished.

5.1.8 Preparing the roof reinforcement

Turn the prepared reinforcement of the roof over and start covering it from the inside with cloth. You must sew the cloth (sisal, jute or nylon, as for the wall) to the reinforcement. It is imperative that the cloth remains in the same shape as the dome when you turn the roof back over into the normal position, Fig. 5.24. Move the roof onto the tank and put it in position, then tie it in this position using the former vertical ends of the reinforcement mesh, as well as with binding wire using pliers. After the roof reinforcement is secured onto the wall, cut out a 450/450-mm manhole using a hacksaw. Trim off all excess wires from the roof reinforcement. Examine from inside the tank. Where cloth forms a sag, sew it back to the reinforcement. Support and prop up the roof from inside with poles, starting in the centre. Now mark the place (or places) where the downpipe from the roof will be fitted into the tank. This remains an opening. Start plastering and use the same mixture as you used for the wall, keeping it slightly wet. If the mixture falls through the wire it is too wet. After the roof is

plastered with the first coat, cover the entire tank with plastic.

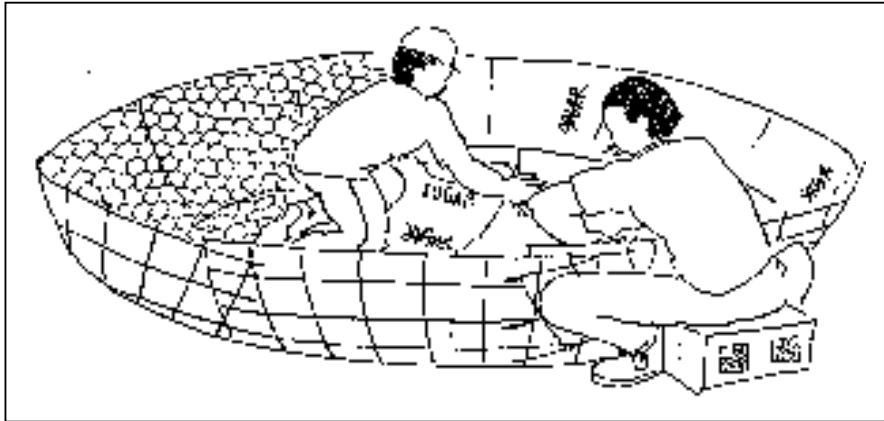

figure 5.24

Next day place the second coat on the roof, smooth it with a wooden float. Prepare the manhole cover using the same size and shape as the opening. Cut a piece of reinforcement mesh slightly smaller than the manhole cover. Shape a mould in the ground or shutter with wood to form handles as shown in Fig. 5.26. Make sure the manhole cover does not become more than 30 mm thick. You can put a piece of chicken wire on top of the reinforcement mesh and fix the end of the handles on the bottom side of the reinforcement. Put the reinforcement into the mould and pour 1 :3 concrete in it, lifting the reinforcement up slightly.

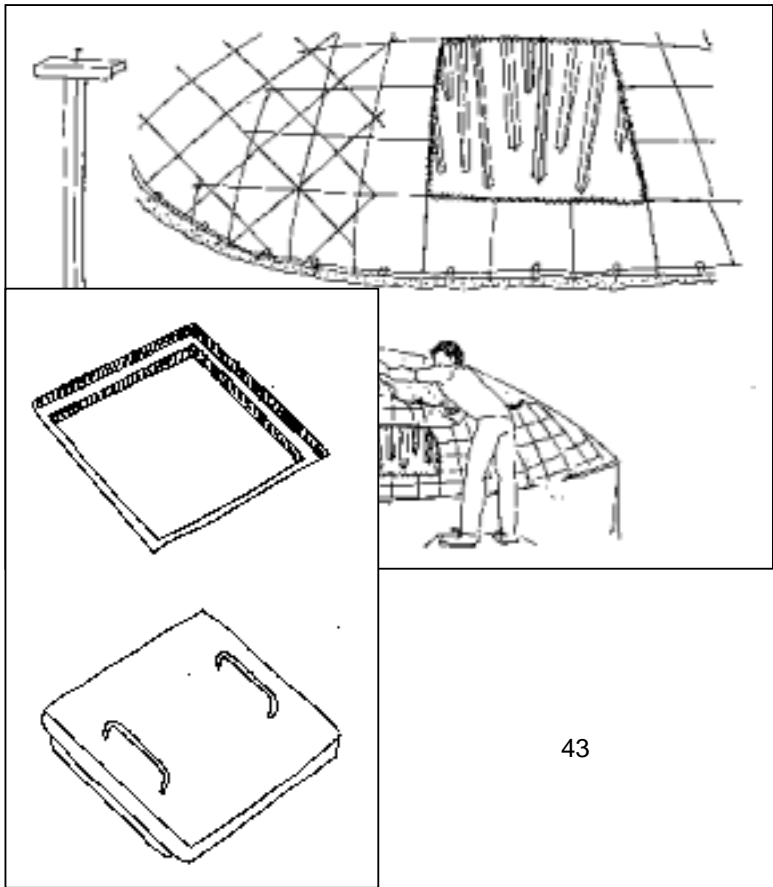
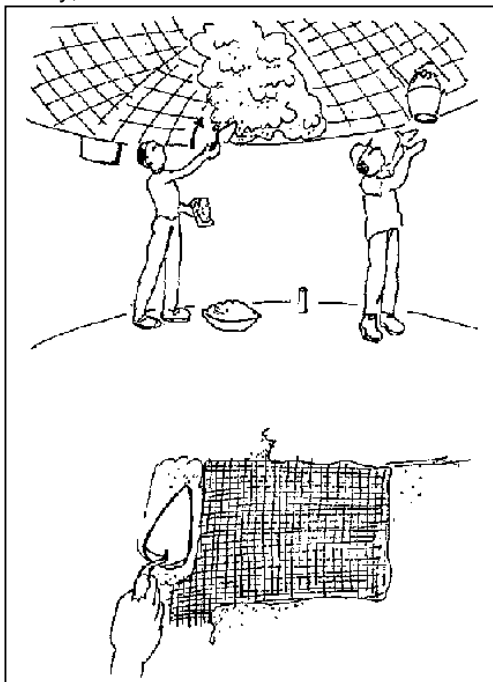

figure 5.25

figure 5.26

After two days you can remove the support poles from inside the tank and start plastering the dome from the inside. This plaster is mainly to cover the sags and the reinforcement and is not supposed to be entirely smooth. But it is important that all reinforcement still visible is covered by at least 10 mm plaster. Remember water in the tank will evaporate and condense inside the roof. The condensation creates corrosion of the reinforcement if it is not properly covered with cement mortar. While plastering cut a piece of galvanized gauze wire overlapping all sides of the overflow opening by 30 mm. Fix it in position with binding wire from inside, then plaster on top of the overlap, keeping the overflow opening uncovered, Fig. 5.27. If you need a scaffold inside the tank to reach the dome for plastering, make sure it does not damage the floor plaster. Always put straight timber boarding underneath the scaffold. After the roof plaster is finished, remove everything from inside the tank and clean the floor, using a broom -if available a wire broom. It is very important to clean the floor as well as possible. If there are marks or holes in the floor plaster, patch them with a 1: 3 mixture. Next prepare a mixture like nil, but add one part fine sand (two parts cement, one part fine sand) and water. The consistency should be slightly stiffer than the nil coat you used for the wall. Plaster this mixture on the floor inside the tank using a rectangular steel trowel. After you have finished the last coat, set the floor under water. However, use the water carefully Do not pour a bucket of water on the floor from the manhole. The water will spoil the smooth surface. If you have a hose, put the end on the bottom of the floor and open the tap. If a hose is not available, take a timber board covered at one end with some cloth, and place this end carefully on the floor through the manhole. The upper end must lean on the edge of the manhole. Then take a bucket of water and pour it along the board slowly, so that it runs down to the bottom. Repeat this until the floor is covered with water. After the



manhole cover has been inserted, the reservoir is ready. Downpipes should be connected but, before the crew leaves the site, water must be filled into the reservoir up to a level of at least 100 mm.

figure 5.27

5.2 Reservoir with factory-made mould¹

5.2.1 General advice

5.2.2 The mould

5.2.3 Foundation slab

5.2.4 Foundation on unstable ground

5.2.5 Assembling the mould and placing the reinforcement

5.2.6 Placing wire reinforcement

5.2.7 External plastering of tank was

5.2.8 Removal of mould

5.2.9 Internal plastering of the tank wall

5.2.10 Screeding the tank floor

5.2.11 Roof support pier

5.2.12 Roof slab shutter

5.2.13 Roof reinforcement

5.2.14 Concreting roof slab

5.2.15 Removing shuttering

5.2.16 Alternative roof structure

5.2.1 General advice

In Chapter 5.1, detailed advice was given on the entire procedure of building a ferro-cement structure. This and the following chapter will only mention the differences in the technique employed. This means there will be no advice on curing the plaster and concrete, including the repeated covering with plastic sheets and splashing with water. The general plastering technique will be named but not explained in detail. Mixing the plaster, testing, sifting the sand etc. are explained in Chapter 3, and remain the same for all types of ferro-cement tanks and waterproof plastering of reinforced bricktanks. The advantages or disadvantages of the various tank structures should first be established by consulting Chapter 2.

5.2.2 The mould

The mould is an expensive capital investment which, if carefully handled, is good for ten to fifteen structures. Since it involves the bending of corrugated galvanized sheets as well as welding, it should be manufactured by a well-equipped workshop experienced in this type of work.

The mould is constructed in six sections. This is necessary to reduce the weight and make it easy to handle, especially when it has to be removed from inside the tank. The sections are fabricated from

rolled sheets of corrugated iron, joined together by mild steel angles (30 x 30 x 3 mm). These steel angles are fixed by spot welding to the corrugated sheets. Three of the sections have overlaps, being 30 mm wider on each side than one sixth of the circle, Fig. 5.29. The other three sections are exactly one sixth of the circumference. The example given in Fig. 5.29 shows a diameter of 4.00 m with a height of 1.85 m. This makes a tank of 20 m³ capacity. The sections are bolted together with timber spacers. These spacers are to be made after all the welding is done and the mould is to be assembled for testing. The timber spacers are made to cover up unequal parts of the mould and should therefore be made specifically for each joint. They also serve to ease the dismantling of the mould after the wall has been made. The overlapping of the mould sections are to prevent mortar passing through during plastering. Test assembly should be performed on an even and horizontal base, preferably a concrete floor. After all holes for bolts are drilled, the mould should be bolted together. The single parts of the assembled mould including the timber spacers must be marked clearly, so that after dismantling, reassembly is always done in the same way. It is best to number the parts and paint the numbers on the inside with oil paint. Do not forget to number the spacers as well. The spacers should be made of hardwood and oiled afterwards. If carefully handled they can last for some time, but are easily replaceable, Figs 5.28, 5.29.

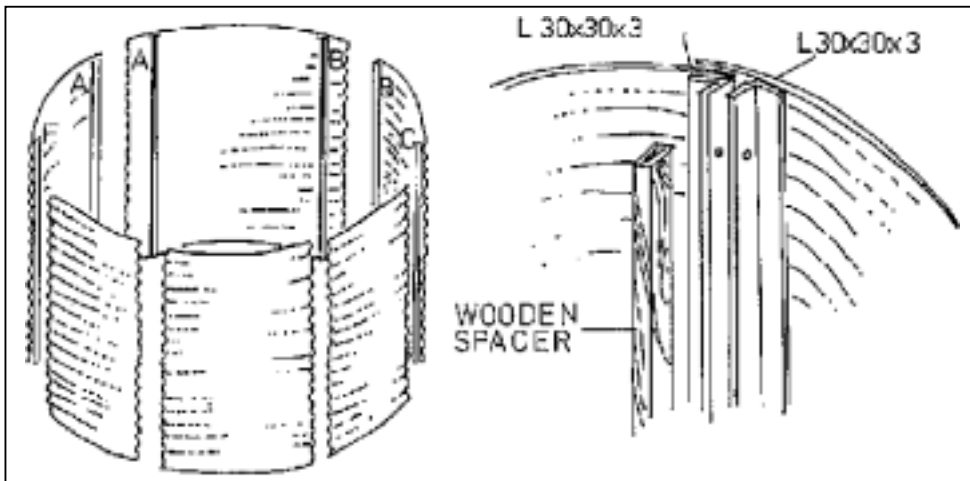

figure 5.28

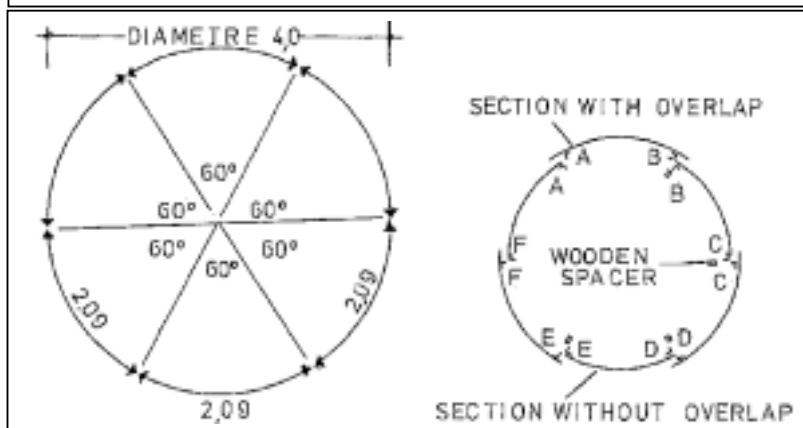

figure 5.29

5.2.3 Foundation slab

Different soil conditions require different foundations. The foundation slab can be constructed as described in Chapter 5.1. If welded reinforcement mesh is not available, it can be substituted by one layer of fencing mesh combined with one layer of chicken wire. If reinforcement rods are available, any size above 4 mm diameter can be used to produce a mesh as shown in Fig. 5.30 by tying

crossed rods with binding wire. The squares should not exceed 150 mm. If only reinforcement bars of 10 mm or more diameter are available, the squares can be enlarged up to 200 mm, but in this case one layer of chicken wire should be fixed to the self-made mesh.

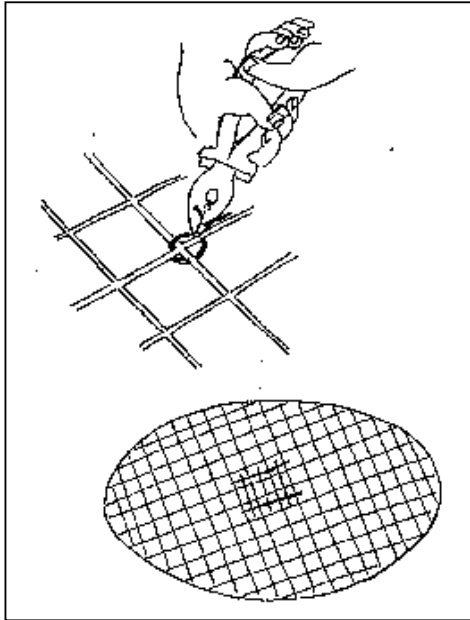

figure 5.30

If you intend to cover the reservoir with a concrete slab, there should be a pier in the centre of the tank to support it. This requires double reinforcement in the centre of the floor slab. The concrete slab can only be constructed if sufficient reinforcement is available. If this is not the case, the roof can be constructed as a ferro-cement dome, as described in Chapter 5.1. If you intend to choose this type of roof there is no need to double-reinforce the centre of the floor slab, since a pier to support the roof is not needed.

5.2.4 Foundation on unstable ground

In general it must be said that any foundation on unstable ground remains a task. Sometimes it is advisable to choose another place where ground conditions are more favourable. But, as explained already for reservoirs, there are not many suitable places if the best catchment position is to be achieved. In the case of unstable soil the best and usually cheapest method is to exchange the soil. After marking the area of the tank foundation, extend the radius for another 500 mm and excavate all soil which is not stable, even if you only reach the stable soil at a depth of 1.00 m. If, for instance, even at this depth stable soil occurs on one side but the other side is still unstable, continue to excavate until your entire ground appears to be stable enough for the structure. Now find backfilling material. This can be old bricks and gravel. Natural hardcore is preferred. Fill this material in layers of not more than 300 mm and compact mechanically by pile-driving. Do not backfill more than half a metre per day and fill the compaction with water overnight. Next morning first pile-drive the work from the day before. After the backfill is finished, keep compacting for one week, filling up with water once a day and recompacting the following day. Then construct a concrete slab foundation as described in Chapter 5.1.

Another method to be applied whenever there is uncertainty about the soil conditions is the ring foundation. Mark the external diameter of the slab and then mark another circle reducing the radius by 500 mm. Between the external and internal circle dig out a trench of 400 mm depth, Fig. 5.31. Do the same in the centre in a square or circular shape of 600 mm (in case you need a pier). The bottom of the trench must be levelled and recompacted. The same applies to the area inside the

circle. The foundation and slab area is now ready for reinforcement. See Chapter 6 for reinforcement of foundation. Follow the advice given there for the construction of the slab too. Make sure it will be level and smooth, otherwise there will be problems in assembling the mould. Before concreting the slab, do not forget to place the water tap unit as shown in Fig. 5.8.



figure 5.31

5.2.5 Assembling the mould and placing the reinforcement

The mould is in six sections, each marked to ensure that they are assembled in the correct order. Tapered wooden spacers are used between the frames to make it easier to remove the sections (Fig. 5.28).

Assemble the mould loosely near the base and check that all the pieces are present and fit properly. This should be done before the mould is required.

Find the centre of the slab and mark a circle on the slab the same size as the mould to ensure the mould is centred on the base.

Take the first section A-B and place it on the line. Take the second section B-C, and place it on the line with the overlap outside the first section and the letters matching.

Place the wooden spacers between the metal flanges and bolt them together loosely.

Do not tighten until all sections are assembled.

Bolt the remaining sections together in the correct order (B—C, C-D, etc.) until the mould is loosely assembled.

Using the circle on the slab as a guide, move the sections until the mould is circular and in the centre of the slab.

Tighten all bolts.

Place paper at the bottom of the mould to prevent oil from spilling on the concrete. Using shutter oil

(or old engine oil) paint the outside of the mould. If oil does get on the concrete it should be cleaned off. Make sure the mould is oily, but that no oil runs off.

Ensure the mould is in the right position. Check this by measuring the distance from the mould to the edge of the concrete slab. Do not start reinforcing until the mould is assembled and stable.

5.2.6 Placing wire reinforcement

Wrap the chicken mesh around the bottom of the mould once with approximately 50 mm tucked under the mould to the inside, Fig. 5.32.

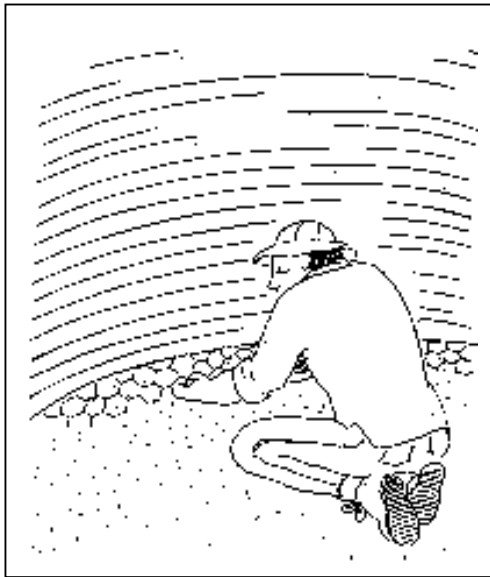
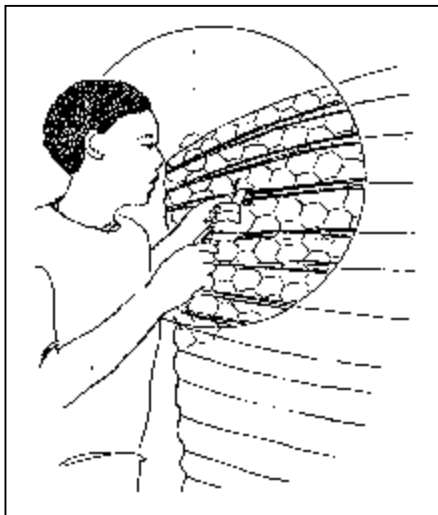

figure 5.32

When you have reached your starting point, pull the chicken mesh, cut it and tighten it, overlapping by 100 mm, then start again above the first circle, overlapping the already fixed mesh by about 100 mm. If the height of the tank requires a third circle of wire mesh, do the same again, overlapping the second circle by 100 mm.

Wrap the chicken mesh around the top of the mould. The top layer should overlap the mould by approximately 100 mm and the remainder is folded over the top of the mould.

Wrap 8-gauge fencing wire around the outside of the chicken mesh, starting at the bottom. The corrugations are used to keep the spacing even. The wire should be wrapped with two wires in each corrugation for the first eight corrugations from the bottom, and then once per corrugation up to the top three, which again should have two strands each.



Use the thin tie wire to fasten the chicken wire to the fencing wire to prevent it from slipping, Fig. 5.33.

figure 5.33

5.2.7 External plastering of tank was

Also see Chapter 5.1 and general advice for material and mixing in Chapter 3.

Mix the first batch of mortar (1 :3 cement: sand, as stiff as possible). Make the first batch small, about one wheelbarrowful. Although the method of application is similar to plastering a wall, progress will be slow at the beginning. Make sure the mortar is stiff and not too wet. If it is too wet it will slip and leave cracks in the plaster which should not happen at all.

Start plastering at the bottom and work up. Try to work evenly around the tank. But remember there will be another external coat so if the plaster is not very even and smooth this can be put right with the second coat.

Apply the first coat thinly. Make sure all the corrugated iron is covered but some of the wire can still be left showing. You will experience that the more plaster you try to apply for the first coat, the more difficult it is to prevent the plaster from slipping. The right technique can only be learned by experience.

Leave a hole at the top for the overflow, about 100 mm below the top of the mould. Ensure the mortar remains damp by covering the finished parts with plastic. This is especially important in bright sunlight and on hot summer days.

The second coat can be applied as soon as the first coat is stiff enough, and so it is possible to do both on the same day. However if there is any doubt it is better to leave it until the following day.

Remember that the mortar will require wetting and covering when finished.

Mix the mortar in the same way as the first coat (1 :3 cement: sand; -stiff).

Plaster up from the bottom uniformly.

Plaster as thinly as possible but be sure all the wires are covered. Smooth the surface using a wooden float. This is the outside

finish of the tank, so try to make a smooth surface.

Keep plaster damp while you work —do not let it dry out. When the second layer is completed, dampen with water and cover with plastic immediately: Leave to cure for at least one full day.

5.2.8 Removal of mould

Fig. 5.34 shows the ferro-cement wall with the mould still fixed. After completing the second layer of plaster, the tank should be left at least one full day before removing the mould.

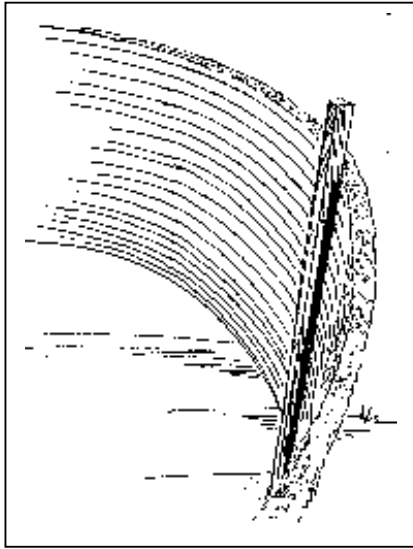

figure 5.34

Remove all bolts.

Remove all the timber spacers.

Starting at joint A-A, pull the edge of the inner panel A-B.

If the panel sticks, lever off gently using the flange of the adjacent panel. Do not knock the shutters as the plaster will still be soft and can be easily damaged.

Remove panel A-B completely.

Repeat with panels C-D and E-F.

Remove panels B-C, D-E and F-A.

Inspect plaster inside and outside for damage.

Wet inside and outside of plaster.

5.2.9 Internal plastering of the tank wall

Before you start this work remove all leftover oil visible on the plaster. This must be done very carefully, washing away with lots of water.

It is possible to plaster inside the wall of the tank as soon as the mould is removed but, as before, remember that the plaster must be applied in one continuous layer. If you are not sure there is enough time for this, start the next morning. But do not forget to cover the wall. Access to the inside should be via a scaffold or ladders as shown in Fig. 5.16. Under no circumstances should the wall be exposed to any load. At this stage even vertical load should be avoided.

Clean the overflow hole of mortar and put the pipe in position. The overflow should start about 100 mm below the top, since the reinforcement at the top should not be cut.

Bend up the wire that was left inside at the bottom of the mould. Plaster only up to 100 or 150 mm above the floor slab.

Plaster inside the tank in the same way as the outside, using a 1 :3 mortar mix, as stiff as possible,

and applying the plaster as thinly as possible. The plaster should just be thick enough to fill the corrugations. Cover the wire completely and provide a smooth finish using a wooden float, Fig. 5.35.



figure 5.35

The chicken wire pulled underneath the mould should be tied in the corner. Prepare a mortar fillet in the corner between wall and floor as shown in Fig. 5.36 or apply the technique as shown in Fig. 5.23.

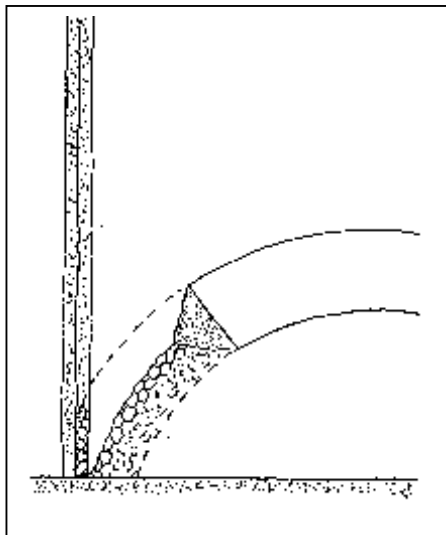

figure 5.36

Using additional mortar, ensure the top of the wall is smooth and level. Trim the high points if necessary, but do not cut off the chicken wire bent inwards.

Make sure that all the plaster is damp and cover immediately with the plastic sheets as soon as it is finished.

Prepare the nil coat and apply it as described in Chapter 5.1.7.

5.2.10 Screeding the tank floor

This layer acts as a final finish and seal to the tank base.

Roughen the bottom of the wall to ensure a good bond between the screed and the wall, cleaning it of all dust.

Wet the mortar fillet and the base slab.

Mix mortar using a dry mix of 1 :3 cement: sand.

Apply a thin screed, approximately 15 mm thick over the floor slab, starting from the fillet and working inwards. Finish the surface of screed by 'shining', i.e. dusting the surface of the screed with cement and using a steel float to produce a very smooth surface.

Dampen walls and floor and cover the tank completely with the plastic sheet.

Alternatively apply the technique described in Chapter 5.1.

5.2.11 Roof support pier

Leave floor screed to set for at least two days, covered in water, before starting the next stage.

Mark the centre of the tank.

Build a brick pier 230 mm wide in the centre up to the level of the top of the tank wall.

Plaster the pier with 1: 3 mortar (cement: sand) to produce a smooth finish.

Dampen all walls and the floor, and cover the tank with PVC sheeting.

5.2.12 Roof slab shutter

Leave the pier and wall for at least a full day before starting work. Making the roof shuttering may damage the walls if it is done too soon after plastering.

Check the inside diameter at the top of the tank.

Mark a circle on the ground with the diameter of the inside of the tank

Cut the sheets of shutter ply in half, lengthwise, to make strips 600 mm wide.

Place the strips of ply over the circle to cover it as efficiently as possible and mark their positions.

Construct the supporting structure of poles and rafters inside the tank, ensuring that the top surface of the ply will be level with the top of the wall. Nail the rafters to the vertical props.

Starting at the side opposite the manhole, lay the sheets of shutter ply on the rafters and cut to shape. Nail the ply to the rafters.

Make an opening in the shutter ply at the manhole, as all the inside timber has to be removed through it later. The opening should be 650 x 650 mm.

Fill all gaps in the shutter or between shutter and wall with paper or plastic.

Lay a damp proof course on top of the tank wall.

Cut hardboard into strips 300 mm wide, or use hardboard from the slab.

Tie the hardboard around the top of the tank to form an edge shutter so that this edge is 100 mm above the wall.

Form an edge shutter for the manhole. This should be 75 mm deep and slightly larger than the hole in the shutter (650 x 650 mm) so that it can rest on the shutter.

Paint the shutter with shutter oil or old engine oil.

5.2.13 Roof reinforcement

On the preparation area cut a piece of reinforcement mesh to the size of the circle. If this is not available use 6-mm reinforcement mild steel and tie together in the same way as the floor reinforcement.

Place the reinforcement in the shutter and either support it with 20-mm plywood blocks or distribute about four wheelbarrows of concrete in the shutter and place the reinforcement on top of this concrete. Ensure that the reinforcement is 20 mm above shutter level.

Double the reinforcement in the centre above the pier which will support the roof.

5.2.14 Concreting roof slab

The concrete used must be of good quality and care should be taken in selecting the sand and stone. See Chapter 3.

Start at the side furthest from the manhole and work evenly towards the manhole opening.

Use a straight piece of timber, the edge shuttering and manhole shutter as guides to form a smooth surface as the concrete is laid (Fig 5.37)

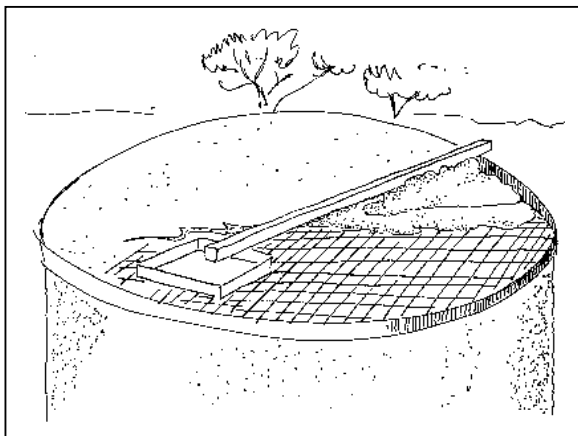

figure 5.37

5.2.15 Removing shuttering

Do not remove the shutter until seven days after the roof slab was cast.

Remove the shutter as gently as possible, starting at the middle.

Remove the shutter from next to the walls last and do not lever or strike the tank walls. Clean all shuttering material and remove all nails.

Save the shuttering for reuse.

After you have removed all shutter material, start to clean the floor carefully. There should be no dust left. If there is any damage in the floor, repair with mortar 1: 1 sand and cement using only sifted sand. Wet the floor for one day or night and apply the nil coat. Since the nil of the wall only goes down to the mortar fillet, this must also be covered with nil. After this job is done, the main structure is finalized. Prepare the manhole cover according to Fig. 5.26.

Remember the tank now has to be filled with water at least to a level of 100 mm to keep it wet. If it is possible the entire structure of the reservoir should be sprayed with water twice a day for at least one week. If this cannot be assured, it should be covered entirely by plastic sheeting to avoid drying off.

5.2.16 Alternative roof structure

If there is not enough reinforcement mesh or rods to be used for making a mesh on the site, it is possible to prepare a roof of ferro-cement by applying the technique described in Chapter 5.1. This type of dome roof does not need a pier to support it. Special care has to be taken when the dome reinforcement is placed on the wall. The bottom circle line must have a ring wire tightly fixed to the reinforcement.

After the reinforcement dome has been placed in position on top of the wall, the ring reinforcement of the wall must be tied to the ring reinforcement of the dome using binding wire. The chicken wire projecting beyond the top of the wall should be neatly fixed to the dome reinforcement.

5.3 Reservoir with made-on-site mould¹

5.3.1 Preparation of the mould or erecting the shutter

5.3.2 Fixing reinforcement

5.3.3 Plastering outside

5.3.4. Inside plastering

5.3.5 Floor finish

5.3.6 Roof shuttering

5.3.7 The roof concrete

5.3.8 Alternative

The ferro-cement technique here remains the same as described in Chapters 5.1 and 5.2. The difference in this technique lies in the method of shuttering applied. In principle it is a made-on-site mould. By means of shuttering, therefore, it can be used in cases which are unsuitable for other techniques, see Chapter 2.2. In addition this technique uses fencing mesh which is also adequate for the technique explained in Chapter 5.2.

Choose the tank size according to the advice given in Chapter 2.4.

Choose the most suitable location of the tank according to the general advice given in Chapter 2.4.

Prepare the ground and dig the foundation. The different techniques required for the different soil conditions are explained in Chapters 5.1 and 5.2.

Don't forget to place the water tap unit, see Chapter 5.1 and Fig. 5.8.

5.3.1 Preparation of the mould or erecting the shutter

Keep the concrete covered with plastic for two days until the slab has set. This means keeping the slab wet. Mark the centre point of the tank and a circle corresponding to the inner diameter of the tank, see schedule Chapter 5.1.

This circle is needed for positioning the framework. Prepare the supporter for the shutter as shown in Fig. 5.38. Using a spirit level make sure the upright rafters have strong support and are fixed in a vertical position. The base timber cross on the slab should be fixed in the centre to avoid dislocation. This can be done either with steel nails hammered into predrilled holes, or by putting pieces of 10-mm or 20-mm reinforcement steel into the still fresh concrete after the slab is poured or during this process. It is imperative that the timber structure to support the shutter be immovable. After you have prepared the four major supportters at right angles to each other, the four vertical rafters must form a square on the slab. All sides should be the same length. Now form an octagon by preparing intermediate supportters. Ensure that the octagon is equilateral, meaning all sides on the ground have the same length. Start fixing the corrugated roof sheets. These sheets must overlap each other by at least one corrugation. They should be fixed using short nails at the top and the bottom. Fix the sheet about 20 mm above the concrete slab. Keep the last sheet unnailed and use this opening to go inside and check the supporting structure. If necessary fix additional spreading stabilization, see Fig. 5.39.

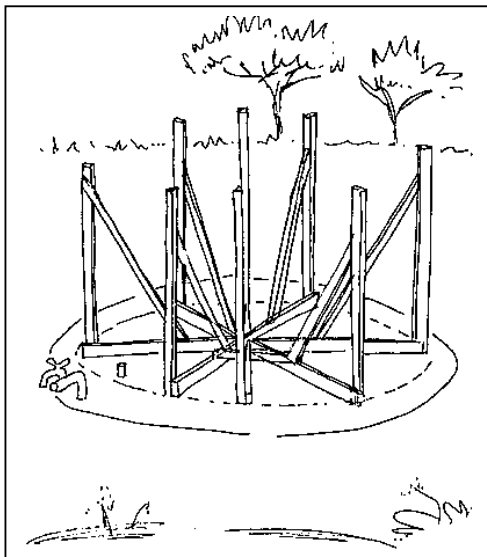

5.38

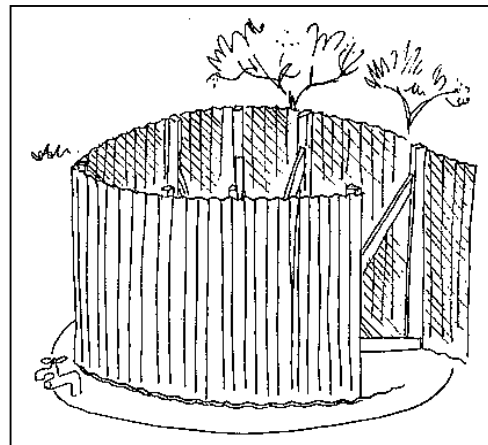

5.39

5.3.2 Fixing reinforcement

After the shutter is closed and the last roof sheet closely fixed, tie soft wire tightly around the galvanized sheets at least in the upper third and bottom third parts. Now the mould must be well stabilized and really fixed in position. If this is not the case, improve the support structure. Do not

start wrapping the mould with mesh wire before stability is achieved. Once this is done pull out all nails or as many as you can still pull. Then roll wire mesh around the mould as shown in Fig. 5.40. The wire mesh must extend under the sheet at least 150 mm to the inside of the tank, as shown in Fig. 5.32. It also must extend about 200 mm over the top of the sheets. Overlapping must be 200 mm. It will be difficult to push the mesh wire underneath the mould, so the 20-mm space must be kept between the slab and the sheets. Where the mesh is hindered by the vertical supporting structure inside the mould, cut the wire vertically in such a way that both of the cut sides can pass the supporting timber. If the fencing mesh is not tight to the mould, which is likely, use soft wire again to tie it round tightly. The next step is to increase the reinforcement by a layer of chicken wire, overlapping by 200 mm, Fig. 5.41. The chicken wire should be tied loosely to the mesh wire.

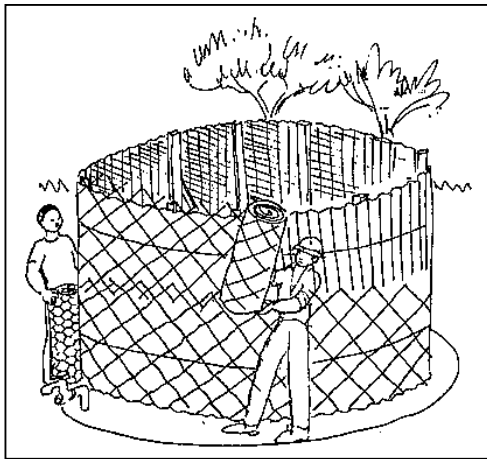

figure 5.40

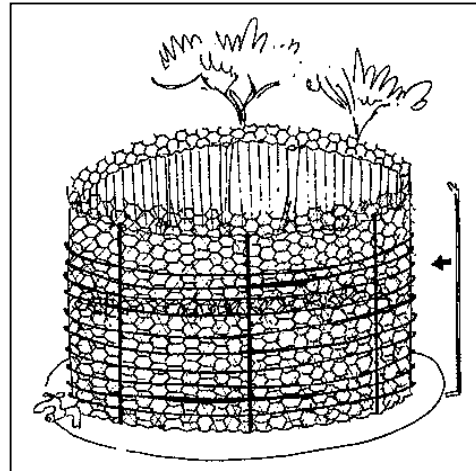

figure 5.41

Prepare 10-mm mild steel reinforcement bars bending them at both ends after cutting them to the right length, as shown in Fig. 5.41. The bent ends are to be added to the height of the mould. These bars are loosely fixed in position by using soft wire and binding them to the fencing mesh. The vertical bars should be equidistant from each other, between 1.00 and 1.5 m. After this is achieved, start wrapping 16-gauge fencing wire around the outside, starting at the bottom. This is the same procedure as shown in Fig. 5.14 and spacing around the bottom, then coil the wire upwards ground. From there you can increase the distance when you should again narrow the distance to 1

5.3.3 Plastering outside

After the reinforcement is finished, prepare for The first plastering coat is done one day, the second day, the second coat is be plastered, wooden float. After the second coat is finished

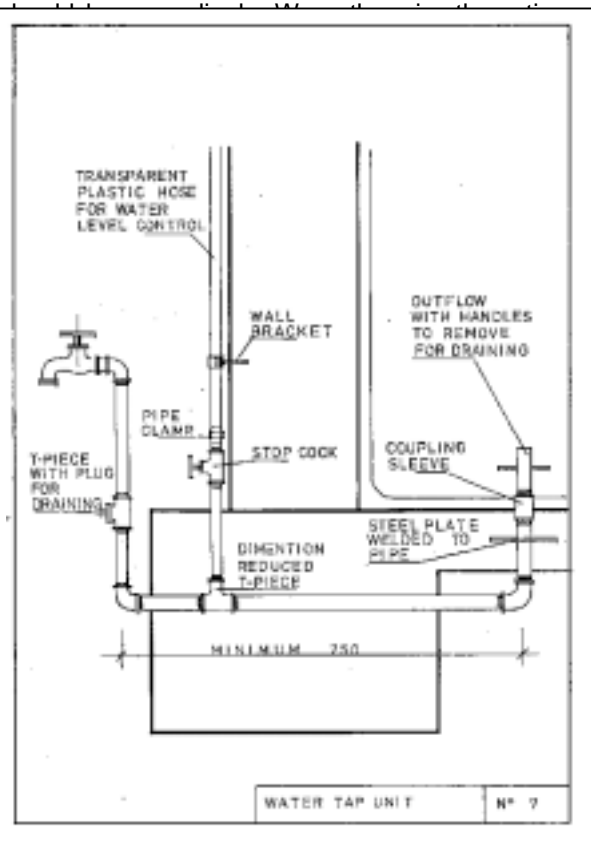
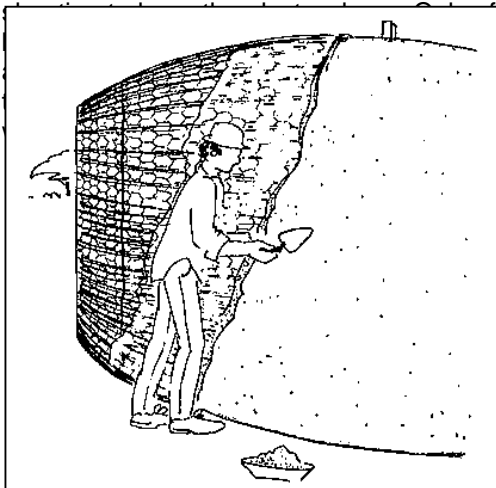

figure 5.42

figure 5.43

5.3.4. Inside plastering

For inside plastering again see the advice given in Chapters 3 and 5.1. The wire mesh which was pushed underneath the mould provides reinforcement for the corner between the wall and the floor, about 100-150 mm up the wall and inside the floor. Use a glass bottle as described in Chapter 5.1 and as shown in Fig. 5.24. After this is done or before you execute the curved corner, apply the nil coat to the wall.

5.3.5 Floor finish

Floor finish is to be performed as explained in Chapter 5.1. The construction can be done before shuttering the roof or after the roof is finished and the shutter removed. The advantage of doing the job before shuttering is the easy access for the material that has to be brought into the tank. The disadvantage is that the floor finish cannot be protected against damage during the work process. To apply the floor finish after the roof shuttering is dismantled means transporting all mortar through the manhole. If this is considered a reasonable procedure, which depends on the situation and the resources on site, then do it. It is the better solution. Otherwise, careful repair of the floor finish must be performed and the nil coat on the floor should always be applied after the shuttering is removed, see Fig. 5.44.

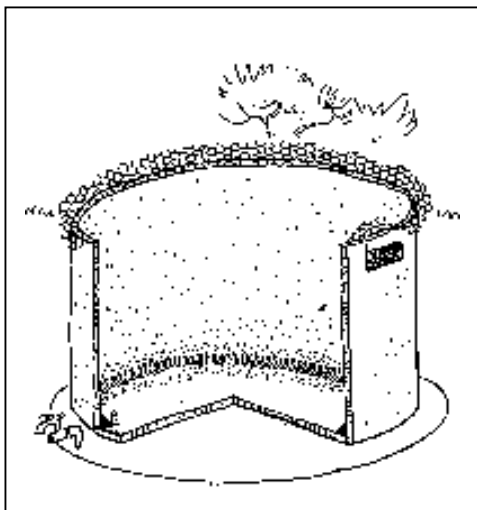

figure 5.44

5.3.6 Roof shuttering

Figs. 5.45 and 5.46 show different stages of the roof shutter based on a central pole. The platform for the pole should be 250 mm higher than the tank wall. The central pole is fixed in position by a cross of timber boards supported at the wall. It might be necessary to fix a second cross as for moulding the shutter, in such a way that the ends of the timber boards (or rather rafters) form an octagon where they are supported at the wall. If this is achieved, segments of chipboard or blockboard should be cut as shown in Fig. 5.46. These trapezoidal pieces of timber are to be supported against the supporting understructure. A manhole of 450 x 450 mm must be made by nailing a frame of this size onto the shutter boards at the desired place. Reinforcement of the roof can be performed with the rest of the reinforcement rods and fencing wire. This should be done in such a way that the reinforcement rods fixed with binding wire to the vertical steel bars of the wall will meet in the centre of the roof, where they are to be tied together. This reinforcement should be covered and tied to the fencing mesh. The extended mesh from the wall must be tied to the roof mesh.

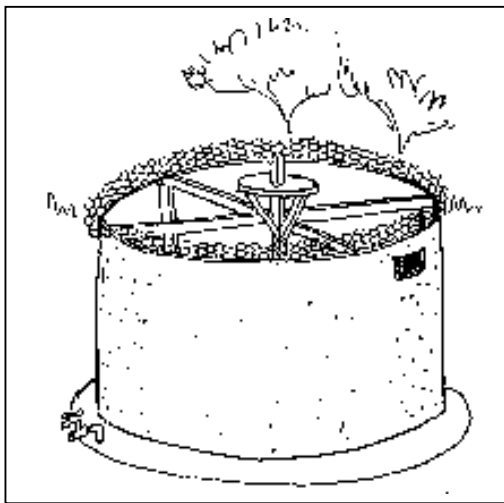

figure 5.45

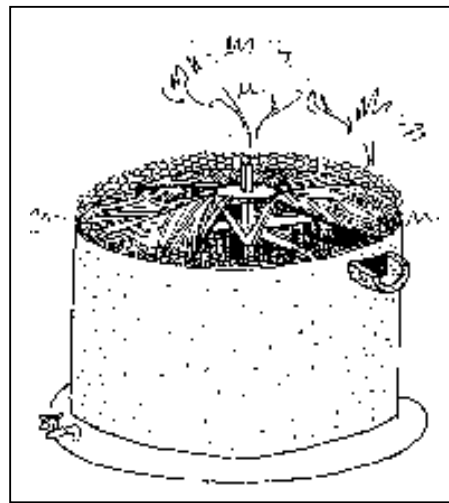

figure 5.46

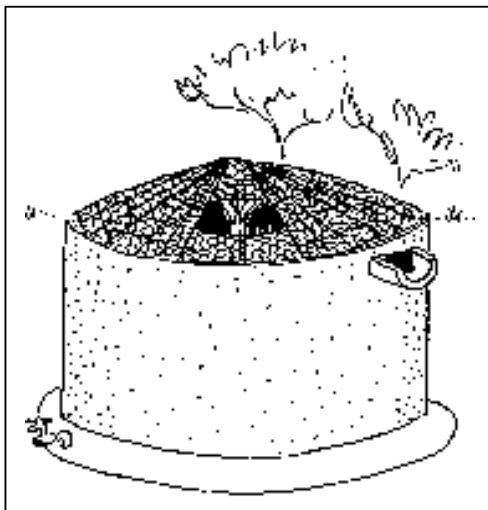

figure 5.47

5.3.7 The roof concrete

After roof shuttering has been finished, the entire opening of the tank covered and gaps filled with paper to ensure that concrete cannot pass through, the roof can be concreted. The concrete should under no circumstances be wet and the mixture remains one part cement, two parts sand, one part ballast.

5.3.8 Alternative

The roof structure described in Chapter 5.2 can also be used for this type of tank. But remember it requires a centre pier and the double reinforcement of the centre of the tank floor. This means the decision should be made before the construction work starts. It is also possible to use the roof structure of the tank described under 5.1 but this requires welded reinforcement mesh or reinforcement rods as described in this chapter.

5.4 Repair of ferro-cement reservoirs

Repairing a ferro-cement tank is easy but should not encourage slipshod work. If the structure is finished and cured as described, then no leaks are likely to occur. Small leaks which create only a wet stain need not be attended to, since they will close after some time. Only leaks where water flows out have to be repaired.

The major problem is not the repair work as such, but the fact that leaks usually cannot be identified until the reservoir is filled. As indicated earlier, the value of the water which is then wasted should be considered. As mentioned, curing after the structure is finished as well as while it is still under construction is just as important as the quality of craftsmanship and material. But, to make it entirely clear, no reservoir -and this applies to the bricktank as well -should ever become entirely dry. Only cement structures which never dry off remain waterproof in the long term. This means that, after the curing period ends, a reservoir has to be filled with water. If as is the case in Botswana there are long periods without rain, or even a drought, a reservoir cannot be kept without water until rain eventually occurs. Thus it is advisable to fill the cistern with borehole water. This will not only preserve the structure, making curing unnecessary, but also furnish immediate evidence of any leaks. If there is no rainfall some days after the structure is finished, and the necessary amount of borehole water is not available, a minimum filling of 100 mm is a must. Since reservoirs might be built in remote areas with almost no access to water and the likelihood of rainfall doubtful, the minimum fill must be provided. In addition, especially in hot arid climates, the structure must be covered on all sides with plastic foil in such a way that the moisture of the mortar cannot evaporate. This means the plastic sheets must be tied up with overlaps so that the wind cannot blow them away. If a leak appears when the tank is eventually filled with rainwater, it is more appropriate to consume the water than drain it to repair the leak. Two different methods of sealing an already filled reservoir from the outside can be tried, provided the material needed is available. However, there is no guarantee that these methods, or rather tricks, will seal the tank, but since they do not affect professional repair, they might be tried if large amounts of water are at risk.

Rapid setting cement

If it is possible to obtain a few kgs of this cement, make a simple test before you buy it. Take a clean tin, pour in some clean water, and add some cement slowly, stirring it with a stick. When the water/cement mixture becomes plastic, take some of it in your hand and mould it. This cement must become very warm in your hand and by the time the heat disappears it must harden instantly. If this test fails to produce the required result, you have either got the wrong cement or the material is overdated, or has become moist, losing its property, and cannot be used. If the test is successful, buy the amount you estimate you will need. At the tank leak start to enlarge the hole where the water is running out. The hole should at least be 10 mm large and just touching the reinforcement. While

you enlarge the hole, more water will flow out. Therefore you should make all preparations in advance, having all tools and material at hand. The best way to do the job is with two people. One prepares the hole for sealing, the other prepares the material. As you have experienced during the test, there is a very short time span during which the cement is still plastic. This is the right time when the cement has to be forced into the hole. Experience has shown that the best tools for this job are a screwdriver used as a chisel, a light hammer, and a piece of timber a little bit smaller than the hole. With the chisel shape the hole like a swallow-tail, if possible, pressing the cement into the hole at the right moment using your thumb. Take the timber piece and the hammer at the last moment before the cement sets and press the plug in by hammering the timber. This trick is likely to work if the leak is not big and some tests are first made to find out the cement's exact setting time. All that is required for this repair work is fast action.

Sodium silicate

This is a water-clear viscous liquid. It can be tried to seal leaks if the water flows out without pressure. Prepare the base for the job using sandpaper to achieve a slightly rough surface of the cement wall. Open the bottle or container with sodium silicate only when you have completed preparations, since this chemical hardens on contact with the air. Use a spatula or a thin metal sheet to apply it, using the same technique as described for the nil coat. The sodium silicate should cover an area slightly larger than the leak. This method has often been used with much success.

Even if the two methods for sealing the tank from the outside remain unsuccessful, they have not done any harm to the structure and do not influence the professional repair work required for ferro-cement structures, since the rapid setting cement or the sodium silicate can be chipped off together with the-original cement mortar.

The repair work requires the same attention to the quality of material and mixing as the construction work. If the sand which was used for construction is not available, or if the source of sand is unknown since the repair work only becomes necessary years later, material must be tested in accordance with Chapter 3. It is again important to sift the sand through gauze wire mesh (mosquito wire mesh). Mixture should be three parts sand with one part cement. There is a considerable risk of creating a new leak since different mixtures result in different expansion of this material. This might lead to the patch cracking away and leaking at the edges. It has therefore also to be stressed that the original construction work should follow strictly the advice given. It can sometimes be observed that the amount of cement is increased to be on the safe side. This is unnecessary and can result in repair problems since after some years there will be nobody who remembers the original mixture. Repair of ferro-cement tanks should not be done using other than normal Portland cement. We can only warn against the use of e.g. rapid setting cement, since the property of this material differs greatly from the original Portland cement, as shown in the example above. Different expansion also creates problems likely to result in new leaks if the mortar for repair is wet. Although the usually small patches can be filled with mortar containing more water than the original material, this seal will not last since the material will shrink and by doing so will most likely result in another leak. Small leaks should be opened by using a chisel and hammer, chipping the mortar around the leak, down to the chicken wire. This must be done from inside the reservoir. It can happen that the leak inside the tank is not visible at the wall. In this case hammer a nail through the wall from the outside. This has to be done rather carefully, knocking the nail with short hammer movements. Use a thin 2 1/2 inch nail. Where the nail appears inside is not necessarily the point of leakage. In all those cases where this method has to be used, the surrounding area with a diameter of 150 mm should be chipped away. This job must be done carefully so that no cracks develop on the outside, since this part of the wall will remain untouched. The nail should be pulled out again.

Preparations to be made for the patch differ depending on whether the tank is in use, meaning water is purposely drained, or there is a minimum of water left and/or the leak occurs in an upper part of the wall where the ferro-cement is rather dry. If the area of repair is dry' it is necessary to wet it by

splashing it with water. This procedure has to be repeated several times from inside and outside until an area of at least half a square metre is really damp. Only then should the moist mortar be filled in with a trowel and the surface smoothed (trowel finish). The mortar must be stiff or it will drop at the top, creating a new leak. If a nail was used to find the location, the hole should be filled from the outside at the same time. It is important to protect the outside repair area of the tank from the sun. If possible a piece of plastic should be tied to the patch from the outside. If this is not possible the outside area has to be splashed with a lot of water every two hours, and the inside two times a day. This curing must be continued for weeks, unless the reservoir can be filled, although applying the nil coat on the patch should be done the next day, Fig. 5.48.

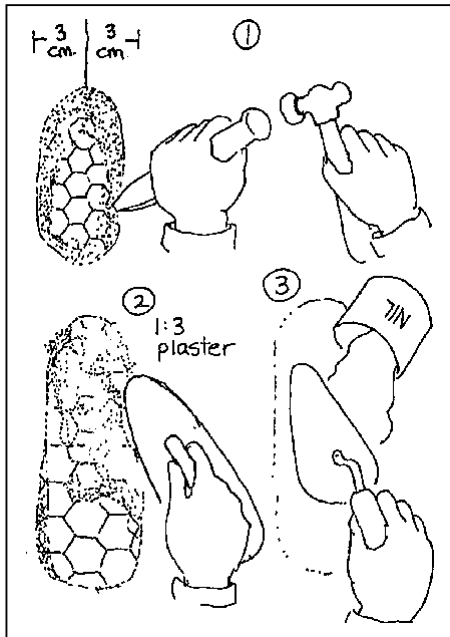

figure 5.48

Larger repairs require the same technique in principle. Because of the nature of the structure, such repairs are seldom and become necessary either immediately after the tank is filled for the first time (in which case they are the result of shoddy workmanship), or they are created by external force, for example if a car bumps the tank. If major damage has to be repaired, the area should be cleared of all material inside and outside of the wall by careful chipping and without damage to the reinforcement. If the reinforcement was damaged by external force, a larger area has to be cleared to make it possible to patch the reinforcement. If this is welded reinforcement mesh and is bent inside without a break, do not try to rebend. This will further damage the wall. If it is broken it can be rebent into position and tightly tied together using binding wire and pliers. The area then has to be cleared of all damaged chicken wire and a patch of two layers must be tied to the reinforcement mesh. If the external force has damaged the coiled fence wire, this should be rebent too. A serious problem occurs only if this damage is close to the bottom. However, in these cases too a repair should be attempted, since there is a good chance that the tank can still be used. Before plastering can start, the surrounding area must be splashed with water as described above.

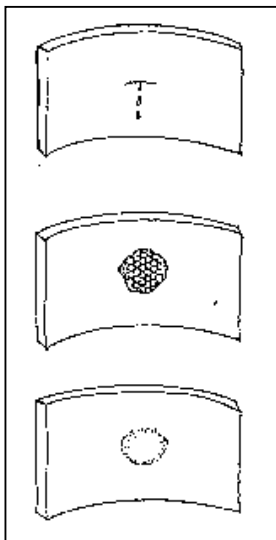

figure 5.49

Repair of large holes where all material has been removed from inside and outside must be performed using the same technique as originally used. That means, if the structure has been built on a mould, it is necessary to shutter the hole from the inside and to apply two coats of plaster from the outside. Cure each coat or cover the area with plastic. If the tank was built without a mould, the plastering to the damage should be done from inside using a shutter outside. Apply the nil coat after one day. Curing the patch for a long period is unnecessary if the reservoir can be filled above the repaired part again after two or three days. After all, this is the best way. Again if small leaks appear they usually close over, Fig. 5.50.

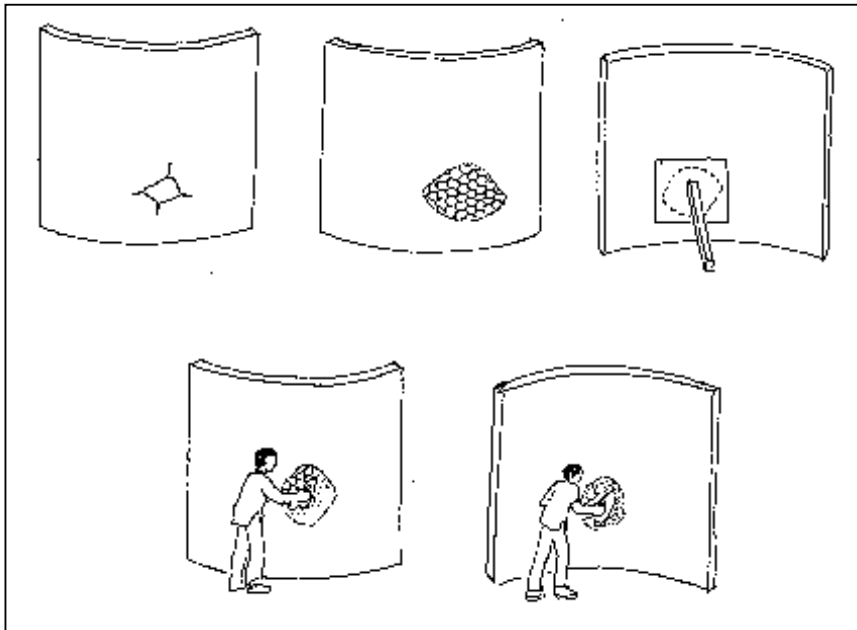

figure 5.50

6. The reinforced bricktank

6.1 The technology

In most cases, it might be appropriate to engage a contractor to build the reservoir. There are several reasons why this is recommended. A contractor is accustomed to organizing material supplies and the work at the site. He knows his staff, and can arrange for the best artisans for the more complicated work. Usually, a contractor is equipped with the necessary scaffolding and shutter material. The larger the reservoir to be built, the more important these become. On the other hand, the contractor probably has no experience with this type of structure. To cope with the different possibilities, this chapter deals with aspects of the construction work in a similar way as with the ferro-cement tanks. Chapter 6.2 provides Standard Specifications and Bills of Quantities to allow tendering of the proposed reservoir. Chapter 6 should provide the necessary information for supervising the construction work.

It should be stressed that, in all cases where tank structures are made at the site, qualified staff are needed. This means, first of all, experienced plasterers are required for ferro-cement structures, as well as for bricktanks. The bricktank requires bricklayers and plasterers, but as these are more or less the same trade, there are few differences between them. While ferro-cement reinforcement can be done by skilled artisans not necessarily experienced~ in the technique, it becomes more difficult-with bricktanks, as qualified reinforcement work must be executed. In many countries, reinforcement binding is a different trade. In this chapter, however, schedules and drawings have been made in such a way as to simplify reading them.

The relatively heavy reinforced foundation for this type of tank may cause surprise, but one must remember concrete is not ferro-cement, and it differs in its properties. Reinforced concrete and brickwork are not as elastic as ferro-cement, It is important to know there are two different forces which influence the structure; one is the soil settlement, the other temperature expansion. Both forces should be controlled by the reinforcement. Cracks in the foundation must not occur because of slight soil settlement, as cracks lead immediately to leaking. Slight soil movement can occur even after years (e.g. tree roots can create soil movement). Temperature variations can be tremendous. In the sun, a reservoir can develop an outside surface temperature of 90°C or higher, while the water in the tank might be 25°C or less. Temperatures on the outside of the tank may also vary. For example, the side of the tank which is in the shade could reach only 30°C. The case becomes even more complicated depending on the amount of water in the tank. If the tank is filled to one-quarter capacity or less, the outside heat could warm up the entire thickness of the wall of the upper part of the tank. Therefore, as demonstrated, there could be totally different temperatures at different points of a reservoir at the same time, and these temperature tensions must be kept under control by reinforcing the brick wall. Experience has shown that the temperature influence becomes clearly visible if a reinforced brickwork reservoir is plastered outside with cement plaster. After some time, microcracks occur. These cracks are not structurally important, but influence the appearance. For this reason, if possible, brick reservoirs should not be plastered outside with cement mortar. Cement mortar also increases the cost of the project, and in most cases is not used, but is replaced with a white plaster limewash which reflects the sun and partially reduces temperature tensions. Plastering bricktanks is sometimes desirable, however. Such a case might arise if the bricktank was constructed together with a new house. The house should be located in line with catchment needs, and the reservoir, although a large structure, should harmonize with the house when covered with lime plaster with a rough surface. As lime is more elastic than cement, fewer cracks will result and, if the surface is rough, they may never be visible.

Procedures for Construction Work:

-Choose the reservoir size according to the advice given in Chapter 2.4. Remember it is usually cheaper to build one large reservoir than two smaller ones which add up to the same capacity. Figure 6.1 shows a 68-m³ reservoir built at Hill School, Lobatse, Botswana, where rainwater from three roofs is drained into one tank.

-Mark the diameter of the tank foundation on the ground to make sure no passage is blocked by the proposed reservoir. Methods of bridging downpipes are explained in Chapter 7.

-In Tables 8-14 (p. 88-91) the amount of material required is specified, including a calculation for wastage. Sand for mortar and the number of bricks required are based on a brick size of 110 mm x 230 mm x 70 mm in Southern Africa. If your brick size differs considerably, you must recalculate the number of bricks and the amount of sand and cement required for bricklaying. Slight differences should be ignored. In Botswana, cement bricks have been used, but burned clay bricks can be used if available according to standard. As tests for quality need to be made in a laboratory, finding out about the quality of a brick on the work site is very difficult. If the supplier cannot submit a certificate, and there are doubts about the quality of the bricks, they should be sent for testing before they are used. For example, if a brick is not as hard as it should be for brickwork, you can rub dust off it with your hand. Bricks should be hard-burned and blue in colouring, rather than red in colouring. Burned bricks often differ in size. This makes working with them more difficult and requires skilled bricklayers. If bricks differ in length, build up the wall from the inside to achieve a smooth surface, as this is the side where the waterproof plastering must be done.

- When the material is on site, and arrangements have been made for securing storage space, mark the external diameter of the foundation on the ground. Different techniques for unstable ground are discussed in Chapter 5.2. In principle, these techniques are the same as those required for the reinforced bricktank. The foundation trench can be dug only after the topsoil inside the circle has been removed. All measurements given in the technical drawings assume the ground is stable. In cases where topsoil is not of equal depth, it must be removed to the greatest depth required to hit stable ground at all points (e.g. if the topsoil is about 300 mm in depth, it must be dug out entirely, as the foundation can only start at that depth). When all topsoil has been removed to stable ground, levelling can begin. If there is no topsoil, a foundation should be dug to 100 mm before the trench is dug. This is usually necessary to avoid soil erosion. If there are pockets of topsoil after a layer of 100 mm has been removed, they must be filled with lean concrete. When all topsoil has been removed and the stable ground has been levelled, the ring foundation should be dug as shown in Figure 5.3.1. Measurements for the size of the ring foundation and the thickness of the slab are the same for all tank sizes. All tanks with an internal diameter of 5.5 m or more require a centre pier to support the roof slab (for foundation see technical drawing).

Reinforcement work must be done on site, but a metal workshop should probably bend the stirrups, as they must be of equal size and shape. Dimensions given for the rods are the minimum. It is always possible to increase the dimensions if the scheduled size is not available. For the wall reinforcement, this is crucial. Vertical rods in the wall and ring reinforcement, which can be done with 6-mm rods, should not exceed 10 mm in diameter. This is necessary, as rods cannot disturb the brick bond or the joints which are equal in size. As Figure 6.4 shows, the reinforcement must be placed in the centre of the wall. It is therefore imperative to fix the vertical rods precisely onto the foundation reinforcement and to make sure they are not dislocated during the process of concreting the foundation and ground slab. The horizontal ring reinforcement must be tied to the vertical bars from inside, using binding wire and pliers as shown in Figure 6.2. As the joints can be only 10 mm thick, and the reinforcement steel must be covered entirely by cement mortar, any dimension exceeding the one indicated will cause problems. Reinforcement not covered with cement mortar will rust. Therefore, flush-jointed bricklaying is necessary. To maintain the required height and assure an equal and solidly filled brick wall, all courses should be indicated on a timber board which should be used as a control mechanism. As shown in Figure 6.5, keeping all vertical bars in position while bricklaying is usually difficult if the height of the tank exceeds 2.00 m. For taller structures, rods can be cut into two pieces, extending the one fixed into the foundation in such a way that it overlaps the other rod by at least 100 mm. The rods should be tied tightly together, above the

1.50-m mark.



figure 6.4

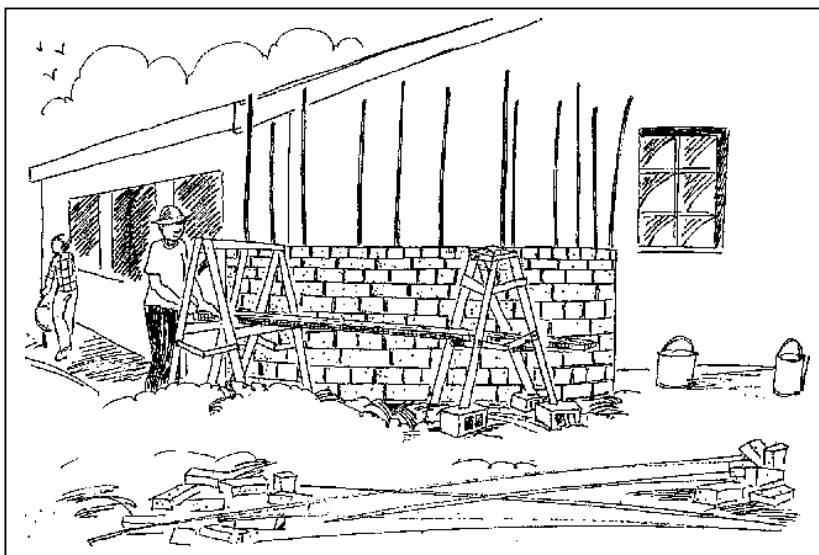

figure 6.5

Seating roof slabs is a crucial detail. As previously explained, temperature variations can be tremendous, and these create movement in the slab which is difficult to control. Therefore, provision must be made for this movement so that it does not create structural damage. A sliding joint is the best way to control this movement. Technical drawing No. 3 illustrates two different types of sliding joints. The first method is as follows: the top of the tank wall must be plastered with a smooth surface, and finished with a steel trowel. This plaster should be applied after the second coat of plaster has been applied to the inside of the tank, and then must be separated from the wall plaster by cutting through the fresh plaster in the form of a V-joint. In this method, shuttering the slab height should be done with hardboard strips nailed to the outside of the wall, exceeding the plaster slab seating by 60 mm or 80 mm, depending on the dimension of the slab. Two layers of thick plastic foil or bituminous roof felt must then be laid on the plastered seating. This will allow expansion of the slab without creating cracks in the wall. The second method can be used if hardboard for shuttering is not available, but requires strips of softboard or a material with similar properties. The shutter for the slab height is one course of half-stone, as shown in technical drawing No. 3. The remaining

half-width of the wall is sufficient as slab seating. Again, the seating must be plastered and two layers of plastic foil must be put under the slab. There must be 15 mm of softboard stripping between the wall and the fresh concrete to prevent the expanding slab from pushing the half-stone wall which acts as a permanent shutter. This material should be removed a few hours after finishing the concreting and the open space should be cleared. Although this method is not as good as the first method described, it will serve the purpose if it is properly implemented. If the slab still pushes the half-stone course, it is easy to remove the entire course and, by doing this, the problem of visibility of movement is eliminated. It must be stressed that the seating for the slab on half the wall is sufficient, but the lintel must be seated on the whole width of the wall.

Waterproof plaster should be handled with special care according to standards described in Chapter 3. Waterproof plaster consists of three coats, each applied to the previous coat while still fresh. Keeping the plaster fresh is often a major problem in hot, arid climates, but this can be done by covering the fresh plaster and by splashing it with water before applying the next coat. Plastic sheets make the best covers.

First Coat:

Before plastering, make sure the wall is moist. Make sure there are as many labourers on site as required for the job, and organize the work in such a way that the mixing, delivery and application of the plaster can be accomplished in a continuous fashion. Remember even a large tank must be completely coated in one operation. This is best done by having two teams of plasterers working at the same time, but starting opposite each other, -working anti-clockwise towards the other team's starting point. Figure 6.6 shows two plasterers working in the same direction: one on the floor and the other on a scaffold. The plasterer on the floor starts plastering an area larger than the area covered by the scaffold. The scaffold is then moved to the wall and the second plasterer starts plastering the upper wall, while the first plasterer continues on the lower part of the wall. There should be no joint between the two working areas or at the meeting point. This might require extra curing of the meeting point until the coat of plaster is closed.

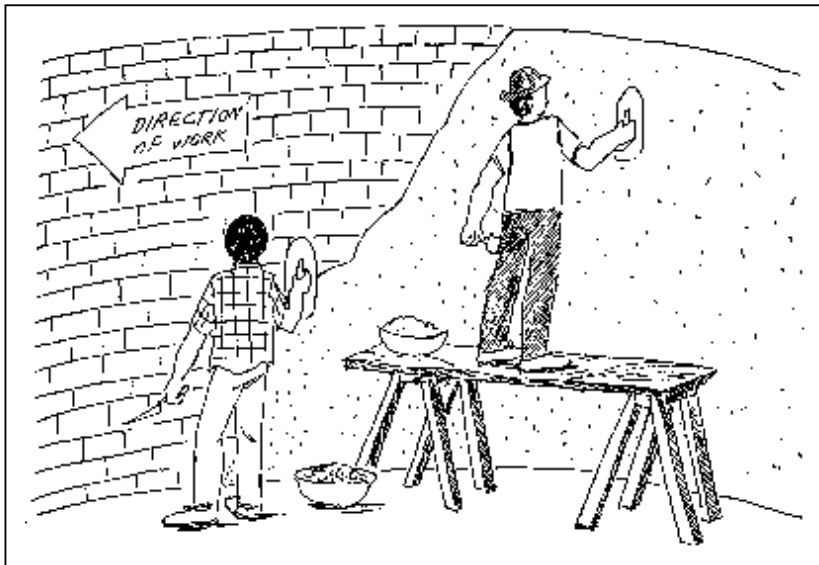

figure 6.6

The first coat of mortar should be composed of three parts river sand and one part cement, as described in Chapter 3. The river sand must be passed through a screen sieve not exceeding 3 mm. If a 3-mm sieve is not available, the sand used in the first coat can consist of the same core size as used in the second coat. The first coat should be a minimum of 10 mm thick and

wooden-floatfinished. Before the second coat is prepared, the wall must be covered from the inside with plastic sheeting to prevent it from drying out.

Second Coat:

The second coat differs from the first, as the sand must be passed through a screen sieve of 1.5 mm, as required for ferro-cement. This process is described in Chapter 3. This coat should be a minimum of 5 mm thick, and wooden-float-finished. The working procedure is the same as that of the first coat. Before starting the second coat, the first coat must be wet, and the starting point should be changed so the meeting points of the first and second coats do not coincide.

Third Coat:

If the second coat can be applied in less than a day' the third coat can be applied when the second coat has been finished. The third coat is the 'nil coat' composition, as described in Chapter 3. As the third coat is applied with a steel trowel, and is no thicker than 2 mm, it can be applied quite quickly. Remember the nil coat should be applied in one continuous process, and make sure enough cement is prepared before starting. as the nil coat consumes about one 50 kg bag of cement per five square metres. The nil coat should not cover the lower 100 mm of the wall, as the corner must be executed as shown in Figure 5.23.

Floor screed mixture should be of the same composition as the first coat of plaster. After the screed is mixed, apply it to the corner with a glass bottle, as described in Chapter 5.1 and Figure 5.23. The nil coat should be applied to the floor the following day, and two-three hours after finishing the nil coat application, the floor should be covered with water for at least three days.

When handling the formwork for the roof slab, make sure the floor is not damaged.

6.2 Tendering a reinforced bricktank

How to use the information in this section

If a reinforced bricktank is to be tendered, the dimensions and amount of material required for building it can be selected from Tables 8-14. This information can then be written in the relevant space on the Bill of Quantities.

This is not the place to explain the entire tendering process, but this brief information will assist you in reaching an agreement with a contractor. Tender documents should be given to at least three contractors, in order to receive competitive prices. There are three different tendering documents: Conditions of Contract, Standard Specifications and Bill of Quantities After the documents have been completed by the contractors, they should be compared to ascertain the differences in prices. The cheapest contractor is not always the best, however, and workmanship demonstrated on previous projects should be taken into consideration.

Examples of the above-listed tendering documents follow.

Contract Conditions

After the tender has been accepted, an agreement shall be made and entered into by and between (Name of Client)_____hereinafter called 'Employer' on the one part, and

(Name and address of contractor) _____ hereinafter called 'Contractor' on the other part.

Whereas the Employer is desirous of the erection and completion of a rainwater reservoir as a reinforced brickwork structure, and has caused drawings of the work to be prepared, and whereas said drawing Nos. _____ have been signed by or on behalf of the Employer and the Contractor, the following is hereby agreed:

1. For consideration hereinafter mentioned, the Contractor will upon and subject to the conditions annexed hereto as Standard Specifications execute and complete the works shown and described upon the said drawings, and as quoted for in the Bill of Quantities.

2. The Employer will pay the Contractor the sum of _____ (hereinafter referred to as the Contract Sum) for the erection of the reinforced brickwork.

3. Date of Completion

Possession of the site shall be given to the Contractor on or before (Day, Month, Year) _____ who shall thereupon and forthwith begin the works, and regularly proceed with and complete the same on or before (Day, Month, Year) _____

4. Damage and Non-Completion

If the Contractor fails to complete the works by (Day, Month, Year) _____ or within any extended time given by the Employer in writing, the Contractor shall pay or allow to the Employer as liquidated and ascertained damages the sum of _____ for every day of non-completion. The Employer may deduct such damages from any money due to the Contractor.

5. Certificates of Payments

The Contractor shall be entitled to a Certificate of Payment on the day of commencing the construction work, not exceeding 33% of the Contract Sum. Final payment shall be due the day of completion providing proof the mentioned structure is waterproof.

Signed and deted by the Contractor _____

1. As Witness (Date _____ Signature _____)

2. As Witness (Date _____ Signature _____)

Signed and deted by the Employer _____

1. As Witness (Date _____ Signature _____)

2. As Witness (Date _____ Signature _____)

Standard Specifications for Reinforced Bricktanks

Material and Workmanship

The whole of the works shall be carried out and completed in the best and most workmanlike manner, and with the best materials of the kind respectively specified. No second-hand materials shall be used.

Protection

The Contractor shall protect all materials and work from damage during the progress of the works, until completion and handover.

Excavation

Nature of Soil

The Contractor shall base his contract sum on excavations in 'pickable' material. Should soft or hard rock be encountered, the contract sum shall be adjusted in accordance with the schedule of rates and measurements taken on site.

Hard Rock

When used, the term 'hard rock' means granite, quartzite or other rock of similar hardness which, in the opinion of the Clerk of Works (Site Supervisor), can only be removed by wedging, drill splitting or blasting.

Soft Rock

The term 'soft rock' is understood to mean all hard ground such as outcrop, shale, decomposed rock and small loose boulders or large stones.

Pickable Material

The term 'pickable material' is understood to mean all earth, clay, gravel, soft shale, made-up ground, etc., which can be removed by means of a pick and shovel.

Trenches/Excavations

The foundation shall not be concreted until the Clerk of Works has signified his opinion in writing that proper bottom has been obtained' and reinforcement shall not be placed until all necessary variations have been measured.

Any excavated matter taken out below the level shown as required to obtain a solid bottom shall be filled up by the Contractor with lean concrete. Measurements of the amount of lean concrete required shall be taken before backfilling begins.

Backfilling

Return and fill around foundations with selected clean, hard, dry earth from the excavation. Backfill should be watered and rammed.

Filling under the Floor Slab

Fill in under solid floor slabs with selected clean, hard, dry earth from the excavation. Water the fill and ram it in layers not exceeding a thickness of 250 mm. The fill should be consolidated and levelled as required.

Should the earth from the excavation be unsuitable or insufficient for this purpose, the Contractor is to supply the required material. No pot clay should be used for filling.

Concrete Work

Concrete work shall consist of providing, placing, curing, etc., the concrete specified in terms of 28-day strength, inclusive of all formwork.

Material Storage

All material shall be as described hereunder. Cement shall be stored in a cool, dry place and used in the order of delivery to the site. Cement which has become damp or has deteriorated in any way shall be removed from the site immediately.

Sand and stones shall be stored in separate bays and heaps, and shall not be placed with earth, grass or other impurities.

Cement

Only Portland cement of an approved brand shall be used, and shall conform to latest British standard specifications in force at the time the tender is submitted.

Stones

Stones for concrete shall be clean, hard, durable particles without soft weathering properties, and shall vary in size from a minimum which fails to pass through a mesh sieve screen of 5 mm to the maximum of 20 mm.

Sand (Concrete)

Sand for concrete shall be clean, sharp, or other approved sand. It shall be graded free from soft particles, clay, organic matter or other impurities, and washed if so directed by the Clerk of Works. Crusher sand shall not be used.

Water

Clean, fresh water from an approved source shall be used throughout. The water shall be free of vegetable or organic matter, earth, clay, acid or alkaline substances, either in suspension or in solution.

Mixing, Transport and Placing Concrete

1: 2: 1 = one part cement, two parts 20-mm aggregate, one part river sand shall be mixed in an appropriate concrete mixer at a time specified by the Clerk of Works, and shall not exceed the amount required for immediate use.

Concrete shall be transported by suitable means without causing any segregation or loss of ingredients, and shall be placed within 10 minutes of leaving the mixer. The mixture shall be plastic in consistency, and under no circumstances be of a consistency which can be poured (chuted concrete). The Contractor shall be directed when and where to use mechanical vibrators. Tamping rods or other suitable means of compacting the concrete may be adopted.

Curing

The concrete shall be covered with a layer of sacking, canvas hessian or similar absorbent material, and shall be kept wet constantly for seven days. Alternatively, when thoroughly wet, the concrete may be covered by a layer of approved waterproof material, which shall be in contact with the concrete for seven days.

Reinforcement

Unless otherwise described, mild steel rod or bar reinforcement which complies with British standards shall be used, and shall be supplied truly straight. Fabric (mesh) reinforcement shall also comply with British standards, and all fabric reinforcement shall be held in place securely by welding. Fabric reinforcement shall be supplied in flat sheets, unless approved otherwise. If fabric reinforcement is supplied in rolls' it shall be cut to the required size immediately, placed on flat

ground and straightened for several days, by pressing it with a heavy weight.

Reinforcement shall be bent to the required detail, and cold-formed by approved means. Reinforcement shall be free from loose mill scale, rust, oil, grease or other harmful matter.

Unless otherwise directed, reinforcement shall be covered with the following: slab -15 mm, beam -25 mm, foundation -50 mm. Concrete covering for reinforcement shall be maintained as shown on detailed drawings, using all necessary spacers and other temporary supports as required.

Formwork

Formwork shall be approved and shall conform to the shape, lines, levels and dimensions of the concrete, as shown in the drawings, and shall be true, rigid, properly braced and sufficiently strong enough to prevent bulging or distortion. All joints shall be sufficiently tight to prevent loss of liquid from the concrete. Immediately before concreting, the area of timber in contact with the concrete shall be thoroughly wet or, preferably, treated with shutter oil. When shutter oil is used, none of it shall come into contact with the reinforcement. The Contractor shall be responsible for any damage to work and any consequent damage caused by negligent handling of formwork. Formwork for roof slab shall not be removed before permission to do so has been given by the Clerk of Works. The minimum period required before removal is 14 days, during which the slab shall be kept wet at all times, or covered with an approved waterproof material which shall be in contact with the concrete for the entire period.

Brickwork

Cement

See Concrete Work above.

Sand

Pit sand free of clay and vegetable matter shall be mixed with fine river sand to produce a workable and strong mortar. Sand for mortar shall be fine-grained and, if required, shall be screened through a 3-mm sieve screen.

Cement Mortar

Cement mortar shall be made of three parts sand to one part cement by volume. Cement mortar shall be mixed in small quantities and shall be used within 30 minutes of mixing.

Bricks

The dimensions, crushing strength and absorption of clay bricks or cement bricks shall comply with standard specifications. Before use, all bricks shall be saturated with water.

Brickwork

Brickwork shall be well bedded and flushed up solid in mortar throughout the whole wall. No one portion of the wall shall be raised more than one metre above the remaining wall. Mortar joints shall be 10 mm thick. All wall reinforcement shall be covered entirely with cement mortar joints.

Brickwork shall be built in cross bond; no false headers shall be used. Horizontal reinforcement shall be tied with binding wire on vertical rods from the inside.

Cement Screed

Cement screed shall comprise one part cement to three parts sand and shall be floated to a true plane surface with a wooden float. Sand used for screed shall be screened through a 3-mm mesh screen to expel all vegetable matter, pebbles, etc. Sand used shall be pure river sand with less than

6% clay, silt, etc. Before commencing work, the quality of the sand shall be proven by test, and submitted to the Clerk of Works. After the float-finished screed has been watered for 24 hours, the nil coat shall be applied, using a steel trowel.

Waterproof Plaster

Three-Coat Plaster

First Coat: 10 -15 mm cement plaster of one part cement and three parts river sand screened through a 3-mm sieve screen shall be wooden-float-finished.

Second Coat: 5 -8 mm cement plaster mixture, as described in First Coat above, shall be screened through a 1.5-mm sieve screen.

Third Coat: This shall be a nil coat composed of pure cement with a consistency of water, and shall be steel-trowel-finished. The plaster shall be cured after each coat has been applied, and when the third (nil) coat has been applied, it shall be covered with waterproof material or soaked thoroughly for seven days.

Bill of Quantities

	Quantity	Unit
	Rate	Amount
Earth: Excavate oversite average 100 mm deep to remove vegetable soil, remove, and deposit according to Employer's advice, not exceeding 50 m	m ²	
Earth: Excavate foundation trench to 'Barth' not exceeding 0.50 m deep and remove, part-return, fill in and ram around foundation	m ³	
Earth: Additional excavations for trenches to reach stable ground	m ³	
Earth: Additional excavation for inner circle to reach stable ground	m ³	
Earth: Backfilling and ramming of hardcore approved material in layers not exceeding 200 mm	m ³	
Earth: Lean concrete for backfilling: 1 part cement: 2 parts river sand: 4 parts gravel	m ³	
Reinforcement: Supply and place reinforcement cage for ring foundation and welded reinforcement mesh for bottom slab consisting of		
Mild steel rods Ø 20	m ²	
Mild steel rods Ø8	m	
Welded reinforcement mesh	m	
Concrete: 1 :2 :1 -20-mm aggregate as specified in ring foundation and slab compacting by mechanical vibrator	m ³	
Reinforced Brickwork: 240-mm brick wall in cross bond reinforced vertically by 10-mm mild steel rods and horizontally by 6-mm mild steel rods		
Brick wall	m ²	
Mild steel rods Ø10	m	
Mild steel rods Ø6	m	
Waterproof cement plaster consisting of 3 coats as specified, inclusive curing	m ²	
Concrete Slab Seating: Plaster of the wall top steel-trowel-finished and placing of 2 layers plastic sheeting to provide for sliding joint under roof slab		
Reinforcement of Roof Slab: Supply and place mild steel reinforcement cage for roof lintel and welded reinforcement mesh for roof slab consisting of		
Mild steel rods Ø6	m	
Mild steel rods Ø20	m	
Welded mesh	m ²	
Formwork and Concreting Roof Slab: Concrete 1: 2: 1 as specified compacting by mechanical vibrator	m ²	
Supply and place water tap unit according to drawing	1	N ^o
Supply and place overflow 150 mm Øasbestos pipe of 800 mm length provided with galvanized gauze wire cover	1	N ^o
Supply and place manhole cover 600/450 mm cast iron painted 3 times with	1	N ^o

bitumen-protected nontoxic paint	
Cement floor screed 1 = 3 inclusive concave moulding of corner	m ²
Lime whitewash of 1 part lime and 1 part river sand for outside elevation	m ²
Carried to Summary	

6.3 Tables of material and quantities

Example 1

A reservoir of 76.0 m³ storage capacity is to be built. According to Table 5 this can have an inner diameter of 5.30 m and a filling height of 3.45 m. The construction work is to be performed by employed craftsmen of repute and labour provided through self-help. Supervision and technical advice are to be provided by a building technician who has fully understood the information given in this booklet. Material must be ordered on time and stored according to advice given in Chapter 3.

Portland cement:

Cement consumption is given in Table 8. The first column indicates the internal diameter. The construction height of the reservoir with filling height 3.45 m is 3.60 m. This is shown in the last column. According to this table the total cement consumption for a reservoir of the given size will be 113 bags of 50 kg each. This is the amount needed for the reinforced concrete, the mortar for bricklaying and the plaster, including a certain amount of waste. If the concrete and mortar are mixed following the advice, the amount of cement will be sufficient for the entire reservoir. The amount should be entered in a "Schedule of material for price comparison".

Schedule of material for price comparison						
Material	unit	quantity	Supplier A		Supplier B	
			rate	amount	rate	amount
Portland cement	50-kg bags	113				
fine aggregate (river sand)	m ³	12.50				
coarse aggregate 20 mm ϕ	m ³	5.50				
cement bricks	No.	6,000				
BRC welded mesh	m ²	74.0				
reinforcement rods 20 mm ϕ	m	159.0				
reinforcement rods 10 mm ϕ	m	66.0				
reinforcement rods 8 mm ϕ	m	341.0				
reinforcement rods 6 mm ϕ	m	32.0				

figure

Fine aggregate (river sand)

Quality according to Chapter 3. Table 10 provides the amount of sand needed for concrete, the mortar for bricklaying and the plaster. The 12.50 m³ include a certain amount of waste.

Coarse aggregate 20 mm ϕ

For foundation, floor slab and roof slab. The last column of Table 13 shows the amount needed: 5.50 m³

Cement bricks

Burned clay bricks also possible if according to standard specification. Table 9 shows the number of bricks for wall height 3.52 m. This is equivalent to construction height of 3.60 m which includes the height of the roof slab. The wall of 3.52 m must be made of 44 courses, based on a brick size of 70 mm and 10-mm joint. This shows the number of bricks needed is 5960, that will be 6000 bricks.

BRC welded mesh

The quality definition 6" x 6" mesh No. 65 or 66 in rolls or sheets. Table 11 last column under internal diameter 5.30 m shows 74 m² for ground and roof slab reinforcement.

Reinforcement rods 20 mm Ø

This is the major reinforcement of the ring foundation. The amount needed is shown in Table 12, being 134 metre run. The next column indicates the distribution which is shown in drawing No. 1 for this diameter, the number being seven.

In addition 20-mm rods are used for the lintel reinforcement. Table 13 provides the information in column six = 25.00 m which has to be added to the 134.0 m and entered in the schedule.

Reinforcement rods 10 mm Ø

It is assumed that rods of 8 mm Ø are available and therefore 10-mm rods are only to be used where this diameter is needed. Table 11 indicates the amount for the vertical wall reinforcement, distribution shown in drawing No 2. The Table shows under construction height 3.60 m and internal diameter 5.30 m an amount of 66.0 m.

Reinforcement rods 8 mm Ø

To be used as horizontal wall reinforcement shown in drawing No. 4. Table 12 shows the amount of steel in columns two, three and four. The construction height of 3.60 m has to be provided with 14 ring reinforcements. For this 256 m are needed.

In addition the stirrups for the ring foundation are of the same diameter and have to be added. In Table 12 the last two columns show the amount = 85.0 m and the number of stirrups = 56. The 85.0 m have to be added to the 256 m and to be indicated in the schedule of material.

Reinforcement rods 6 mm Ø

This is needed for stirrups of the lintel reinforcement cage only. If this dimension is not available, 8-mm rods can also be used. In this case the amount has to be added to the previous figures. Table 13 in column seven indicates the amount of 32.0 m and in column eight the number of stirrups to be bent.

After the amount of major building material has been indicated in the schedule, it is recommended that the different prices be investigated. The more suppliers asked to give their rates, the better. It can be experienced that prices differ from item to item, and it might therefore be appropriate to order from different suppliers.

Example 2

A large reservoir of 152 m³ capacity is to be tendered. According to Table 5 this reservoir a construction height of 3.45 m. For the process of tendering all information is provided in Chapter 6.2. To make use of the Bill of Quantities, it is necessary to find the quantities in the different tables and fill them in on the form.

a) Excavation of ground slab 100 mm
Table 13 column two: 5.46 m³

b) Excavation of foundation trench
Table 13 column three: 3.73 m³

c) Reinforcement for foundation and ground slab

Mild steel rods 20 mm Ø , Table 12 column five: 214.0 m run

Mild steel rods 8 mm Ø , Table 12 column seven: 120.0 m run

Welded mesh No. 65 or 66. Table 11 last column gives the amount for ground and roof slab. For the purpose of this tender it is sufficient to divide this amount 2 = 68.5 m²

d) Concrete as specified for foundation and ground slab. Table 13 columns two and three give the exact amount of excavation which is the same as for concrete: 5.46 m³ + 3.73 m³ =9.19 m³

e) Brick wall in square metres

Table 14 shows the square metres of water- proof plaster for the different sizes of reservoirs. This is the same as the square metres of brick wall. The filling height of 3.45 m is equivalent to the height of the brick wall of 3.52 m. The table shows 82.9 m²

Reinforcement for brick wall 10 mmØ

This is the vertical reinforcement shown in drawing No. 2. Table 11 construction height 3.60 m, amount needed 89.0 m run.

Reinforcement for brick wall 8 mm Ø

This is the horizontal reinforcement, distribution shown in drawing No. 4. Table 12 shows the amount needed as 363.0 m run.

f) Waterproof cement plaster
Shown in Table 14: 82.9 m²

g) Reinforcement for roof slab and lintel

Mild steel rods 6 mm Ø for stirrups of the lintel cage

Table 13 column seven: 43.0 m run.

Mild steel rods 20 mm Ø main bars of lintel Table 13 column six: 42.50 m run.

h) Formwork and concreting roof slab in m² Height of the slab 80 mm

Table 13 column five: 49.80 m²

i) Cement floor screed
Table 14 last column: 44.20 m²

1. Lime whitewash outside elevation

Table 14 shows the square metre inside plaster for the proposed 7.50 m diameter and wall height 3.52 m. The table shows 82.90 m² For the external elevation 5.5 m² have to be added (valid for all sizes): 88.40 m²

Internal diameter (m)	Construction height (m)					
	2.00	2.32	2.88	3.12	3.44	3.60
3.5	53	58	62	62	67	67
3.8	62	62	66	71	71	75
4.0	65	69	74	74	78	78
4.3	73	73	78	82	82	87
4.5	76	76	85	85	90	90
4.8	80	85	89	94	98	98
5.0	88	88	97	97	101	101
5.3	95	99	104	108	113	113
5.5	99	103	112	112	117	123
5.8	110	115	119	124	128	128
6.0	117	122	131	135	135	140
6.3	125	125	134	138	143	147
6.5	129	133	142	147	147	151
6.8	136	140	149	154	158	163
7.0	147	152	161	165	170	174
7.3	150	155	164	168	177	177
7.5	162	166	171	180	184	189
7.8	169	173	182	191	196	200
8.0	177	182	191	195	200	209

Table 8: Consumption of Portland cement for different sizes of reservoirs in number of 50-kg bags

Internal diameter (m)	Height of the tank wall (m)					
	1.92	2.24	2.80	3.04	3.36	3.52
	Number of brick courses					
	24	28	35	38	42	44
3.5	2420	2820	3520	3830	4230	4430
3.8	2620	3060	3840	4150	4590	4810
4.0	2760	3220	4030	4370	4830	5060
4.3	2970	3430	4230	4580	5040	5270
4.5	3110	3570	4370	4720	5180	5410
4.8	3320	3780	4580	4920	5380	5610
5.0	3450	3910	4720	5060	5520	5750
5.3	3660	4120	4920	5270	5730	5960
5.5	3800	4260	5060	5410	5870	6100
5.8	4000	4460	5264	5610	6070	6300
6.0	4140	4600	5410	5750	6210	6440
6.3	4350	4810	5610	5960	6420	6650
6.5	4490	4950	5750	6100	6560	6790
6.8	4690	5150	5960	6300	6760	6990
7.0	4830	5290	6100	6440	6900	7130
7.3	5040	5500	6300	6650	7110	7340
7.5	5180	5640	6440	6790	7250	7480
7.8	5380	5840	6650	6990	7450	7680
8.0	5120	6000	6790	7130	7590	7790

Table 9: Number of bricks for different

sizes of reservoirs including 10% waste

Internal diameter (m)	Construction height (m)					
	2.00	2.32	2.88	3.12	3.44	3.60
3.5	5.50	6.00	7.00	7.00	7.50	7.50
3.8	6.50	6.50	7.50	7.50	7.50	8.00
4.0	7.00	8.00	8.50	8.50	9.00	9.00
4.3	8.00	8.00	8.50	9.00	9.00	9.50
4.5	8.00	8.50	9.50	9.50	10.00	10.00
4.8	9.00	9.50	10.00	10.50	11.00	11.00
5.0	9.50	9.50	10.50	10.50	11.00	11.00
5.3	10.00	10.50	11.00	12.00	12.50	12.50
5.5	10.50	11.00	12.00	12.00	13.00	13.50
5.8	11.50	12.00	12.50	13.50	14.00	14.00
6.0	12.00	12.50	14.00	14.50	14.50	15.00
6.3	13.00	13.00	14.50	15.00	15.50	16.50
6.5	13.50	14.50	15.50	16.00	16.00	17.00
6.8	14.00	15.00	16.00	16.50	17.50	18.00
7.0	15.50	16.00	17.00	18.00	18.50	19.00
7.3	16.00	16.50	17.50	18.50	19.50	19.50
7.5	17.00	17.50	18.00	19.50	20.50	20.50
7.8	17.50	18.00	19.50	20.50	21.00	22.00
8.0	18.50	19.00	20.50	21.00	21.50	22.50

Table 10: Consumption of sand for different sizes of reservoirs in m3 comprises sand for concrete bricklaying and plastering

Internal diameter (m)	Construction height (m)						Reinforcement mesh ground + roof slab (m ²)
	2.00	2.32	2.88	3.12	3.44	3.60	
3.5	23.00	27.00	34.00	37.00	41.00	43.00	37.00
3.8	25.00	30.00	37.00	40.00	44.00	47.00	42.00
4.0	25.00	30.00	37.00	40.00	44.00	47.00	46.00
4.3	27.00	32.00	40.00	43.00	48.00	50.00	52.00
4.5	30.00	35.00	43.00	47.00	52.00	54.00	56.00
4.8	32.00	37.00	46.00	50.00	55.00	58.00	63.00
5.0	34.00	39.00	49.00	54.00	59.00	62.00	67.00
5.3	36.00	42.00	52.00	57.00	63.00	66.00	74.00
5.5	36.00	42.00	52.00	57.00	63.00	66.00	79.00
5.8	38.00	44.00	55.00	60.00	67.00	70.00	87.00
6.0	40.00	47.00	58.00	64.00	70.00	74.00	93.00
6.3	42.00	49.00	62.00	67.00	74.00	77.00	100.00
6.5	42.00	49.00	62.00	67.00	74.00	77.00	106.00

Internal diameter (m)	Horizontal reinforcement for brickwall mild steel 8 mm rods (m run) for different sizes of reservoirs			Foundation ring-reinforcement mild steel 20 mm rods, different sizes		Stirrups for ring foundation mild steel 8 mm rods, different sizes	
	Construction height (m)			m run	Number of rods	m run	Number of stirrups
	2.00	2.88	3.44				
	Number of ring-reinforcements						
	10	12	14				
3.5	121.0	145.0	169.0	90.0	7	56.0	37
3.8	131.0	157.0	184.0	98.0	7	61.0	40
4.0	138.0	166.0	193.0	102.0	7	64.0	42
4.3	149.0	178.0	208.0	110.0	7	68.0	45
4.5	155.0	186.0	218.0	119.0	7	71.0	47
4.8	166.0	199.0	232.0	122.0	7	77.0	51
5.0	173.0	207.0	242.0	126.0	7	80.0	53
5.3	183.0	220.0	256.0	134.0	7	85.0	56
5.5	190.0	228.0	266.0	139.0	7	88.0	58
5.8	200.0	240.0	280.0	146.0	7	92.0	61
6.0	207.0	249.0	290.0	169.0	8	95.0	63
6.3	218.0	261.0	305.0	180.0	8	100.0	66
6.5	225.0	269.0	314.0	186.0	8	103.0	68
6.8	235.0	282.0	329.0	194.0	8	109.0	72
7.0	242.0	290.0	338.0	200.0	8	112.0	74
7.3	252.0	303.0	353.0	199.0	8	117.0	77
7.5	260.0	311.0	363.0	214.0	8	120.0	79
7.8	269.0	323.0	377.0	222.0	8	124.0	82
8.0	276.0	332.0	387.0	227.0	8	127.0	84

Table 11: Vertical reinforcement of brickwall mild steel 10-m rods (m run) for different sizes of reservoirs

Table 12

Tank size internal diameter (m)	Table of quantities							
	excavation ground slab (m ³)	excavation foundation trench (m ³)	ground slab 100 mm (m ²)	roof slab 60 mm 80 mm (m ²)	20 mm rods lintel reinforcement (m run)	6 mm rods lintel stirrups (m run)	stirrups (number)	concrete aggregate 20 mm for all concrete (m ³)
3.5	1.48	1.81	14.80	12.31	17.00	20.50	26	3.00
3.8	1.69	1.95	16.90	14.25	18.50	23.00	28	3.50
4.0	1.85	2.05	18.40	15.60	19.00	25.00	29	4.00
4.3	2.07	2.19	20.80	17.80	20.00	26.00	32	4.00
4.5	2.24	2.29	22.40	19.30	21.50	28.00	33	4.50
4.8	2.50	2.42	25.00	21.75	22.50	29.00	35	5.00
5.0	2.68	2.52	27.00	23.40	23.00	30.00	36	5.00
5.3	2.96	2.66	29.60	26.00	25.00	32.00	38	5.50
5.5	3.16	2.76	31.60	27.90	25.50	33.00	40	6.00
5.8	3.46	2.90	34.60	30.80	33.50	34.00	42	6.50
6.0	3.67	3.00	36.80	32.80	34.50	35.00	43	7.00
6.3	4.00	3.14	40.00	35.90	36.50	36.00	45	7.50
6.5	4.23	3.23	42.30	38.00	37.50	38.00	46	8.00

Internal diameter (m)	Height of tank wall (m)						Floor screed (m ²)
	1.92	2.24	2.80	3.04	3.36	3.52	
3.5	21.10	24.65	30.80	33.45	36.95	38.70	9.70
3.8	22.90	26.75	33.60	36.30	40.10	42.00	11.40
4.0	24.15	28.15	35.20	38.20	42.20	44.25	12.60
4.3	25.95	30.25	37.80	41.00	45.40	47.55	14.50
4.5	27.20	31.65	39.60	43.00	47.50	49.80	15.90
4.8	29.00	33.80	42.20	45.80	50.70	53.10	18.10
5.0	30.20	35.20	44.00	47.75	52.75	55.26	19.70
5.3	32.00	37.30	46.60	50.60	56.00	58.60	22.10
5.5	33.20	38.70	48.40	52.50	58.10	61.00	23.80
5.8	35.00	41.00	51.00	55.50	61.20	18.20	26.50
6.0	36.20	42.20	52.75	57.30	63.30	66.30	28.30
6.3	38.00	44.30	55.40	60.20	66.50	69.65	31.20
6.5	39.20	45.75	57.15	62.10	68.60	71.85	33.20
6.8	41.00	47.85	59.80	64.90	71.80	75.15	36.30
7.0	42.20	49.25	61.55	66.85	73.85	77.40	38.50
7.3	44.10	51.35	64.20	69.70	77.00	80.70	41.90
7.5	45.25	52.75	65.95	71.60	79.15	82.90	44.20
7.8	47.00	54.85	68.60	74.45	82.30	86.20	47.80
8.0	48.25	56.30	70.35	76.40	84.40	88.45	50.30

Table 13

Table 14: Waterproof cement plaster for different sizes of reservoirs (m2)

7. Gutters and downpipes

The efficiency of any rainwater catchment depends to a great extent on the gutter and downpipes. Qualified tinsmith's (or plumber's) work is demanded to fix gutters for catchment. Large roofs especially need precise workmanship. Often workers are seen using ladders, rather than scaffolding, but precise gutter fixing cannot be achieved without a scaffold on the overall length of the eave.

The slope of gutters should be about 0.3-0.5%. This first of all requires precise measuring. However in rainwater catchment, a slope of 0.3 -0.5% often remains theory. As an example: an eave length of 30.0 m would require an overall slope of 90-150 mm from the end to the outflow. But gutters fixed 90 mm below the eave are likely not to catch heavy runoff. Under normal circumstances the problem would not occur as one would furnish a roof eave of 30.0 m with at least three downpipes. This would not only solve the problem of sloping but also reduce the size of the gutter, as the catchment area per outflow is much smaller. In rainwater catchment maximum runoff is to be drained into the reservoir and compromises must be made.

After scaffolding has been erected under the roof overhang, the eave must be checked to see if it is horizontal. Sometimes this is not the case, particularly with long roofs. To measure and compromise the slope a thin wire is to be stretched tightly along the length of the eave and attached to a nail on both ends. If this method is used, a 50-mm overall slope could be obtained for the gutter. This is admittedly next to nothing. However the system will also work if the gutter is absolutely horizontal and straight. Whatever minimum slope can be achieved this first of all serves the purpose to ensure that there will be not even the slightest slope in the opposite direction. Large gutters are usually square. They should not be fixed on horizontal brackets but have a slight slope toward the outside (see drawing No. 8). This means viewing the cross-section of the gutter which must show a minimum slope from the eave corner toward the opposite corner. This will help to increase the rate of draining.

A common mistake observed is the underdimensioning of the gutter bracket. It has to be kept in mind that during heavy downpours gutters can suddenly be filled with water and their weight might increase up to 40 kg/m. To avoid deformation or even collapse of large gutters, brackets must be strong and at distances not exceeding 1.0 m. Brackets for large gutters should never be fixed on purlines only. If the distance between the rafters makes an intermediate support necessary there are two ways of solving the problem. One is to have two different strong types of brackets, the stronger fixed at the rafters, the weaker ones at the purline in between the rafters. The other, often easier, method is to exchange the purline for a much stronger and larger one.

t14

In rainwater catchment downpipes often channel the water over long distances (from one gable side to the other) with a slope of sometimes only 1.5%. In all those cases they are not working as downpipes but rather as covered channels. As a result the downpipes sometimes develop a weight similar to the gutters and must therefore be securely fixed to the wall. Usually downpipes are of smaller dimension than gutters since water falls more or less vertically. In rainwater catchment this is often not the case and downpipes should be of the same dimension as the gutters they are linked to.

Reservoirs at public buildings are often large and, so as not to block the passage, sometimes more than 2.00 m away from the building. In those cases the downpipes must be bridged from the building wall to the tank inflow. It is necessary to suspend the bridged downpipes or to support them. Suspension is done if the wall above the bridge point is high enough. A steel clamp must be put around the downpipe in the centre of the pipe bridge and this fixed by a steel rope with a strong hook plugged into the wall. This has to be done in such a way that gable wall, pipe bridge and steel rope form a triangle. If it is not possible to suspend the pipe bridge, it must be supported. This is done by fixing a welded triangle of steel angles at the wall underneath the pipe bridge. Any pipe bridge must at least be supported or suspended in the centre if it exceeds 1 m in length.

Calculation of gutter and downpipe dimensions

General rule 1.0 cm² cross-section of gutter and downpipe per m² catchment (roof) area.

Catchment area (m ²)	Gutter diameter (mm)	Cross-section (cm ²)	Thickness of sheets (mm)
up to 25	80	25	0.65
25– 40	105	43	0.65
40– 60	127	63	0.70
60–100	153	92	0.70
100–150	192	145	0.70
150–250	250	245	0.80

Table 15

Catchment area (m ²)	Gutter size		Cross-section (cm ²)	Thickness of material (mm)
	height (mm)	width (mm)		
up to 30	41	65	21	0.65
30– 40	51	85	35	0.65
40–100	75	112	70	0.70
100–150	90	140	110	0.70
150–250	115	190	196	0.80
250–450	180	225	364	0.80

Table 16

Example: Catchment area 8.0 x 30.0 m = 240.0 m², cross-section of gutter and downpipe 240 cm². According to Table 15 you can choose a gutter of half-round shape, inner diameter 250 mm or following Table 16 a squared gutter, height 115 mm, width 190 mm.

Appendix: Technical drawings

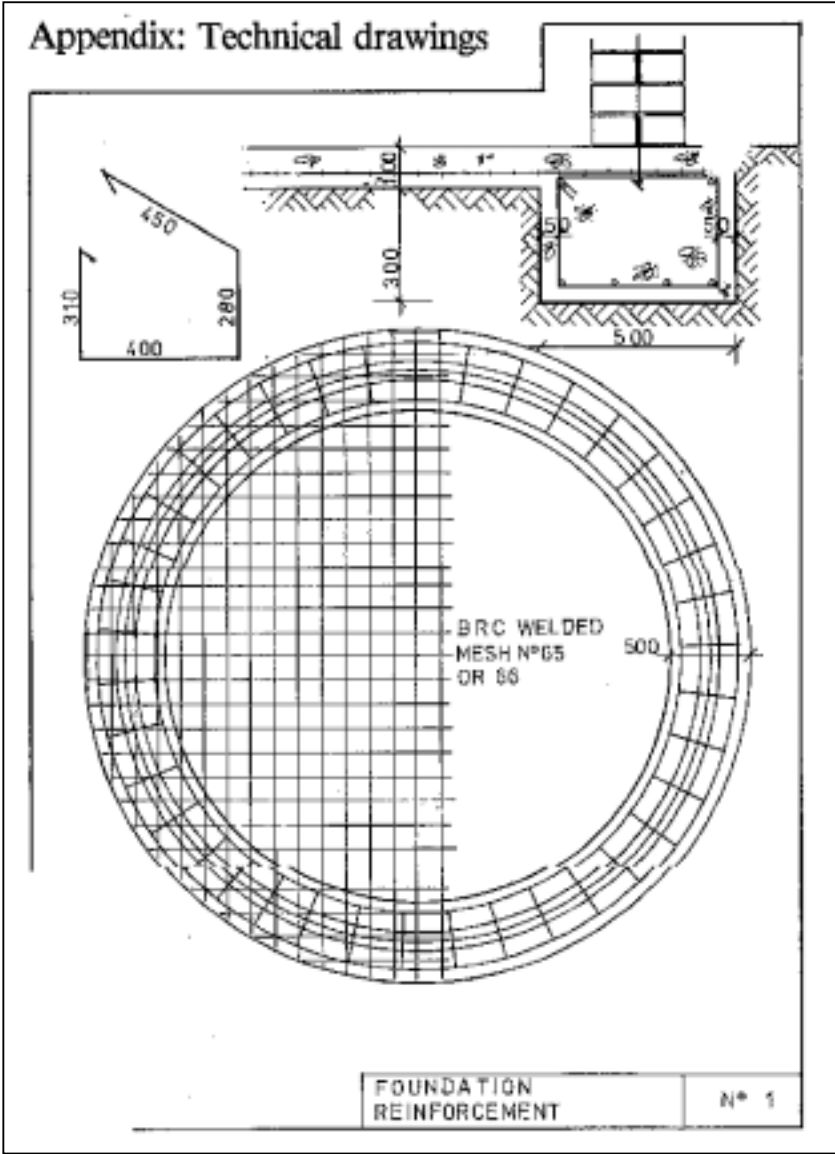

figure

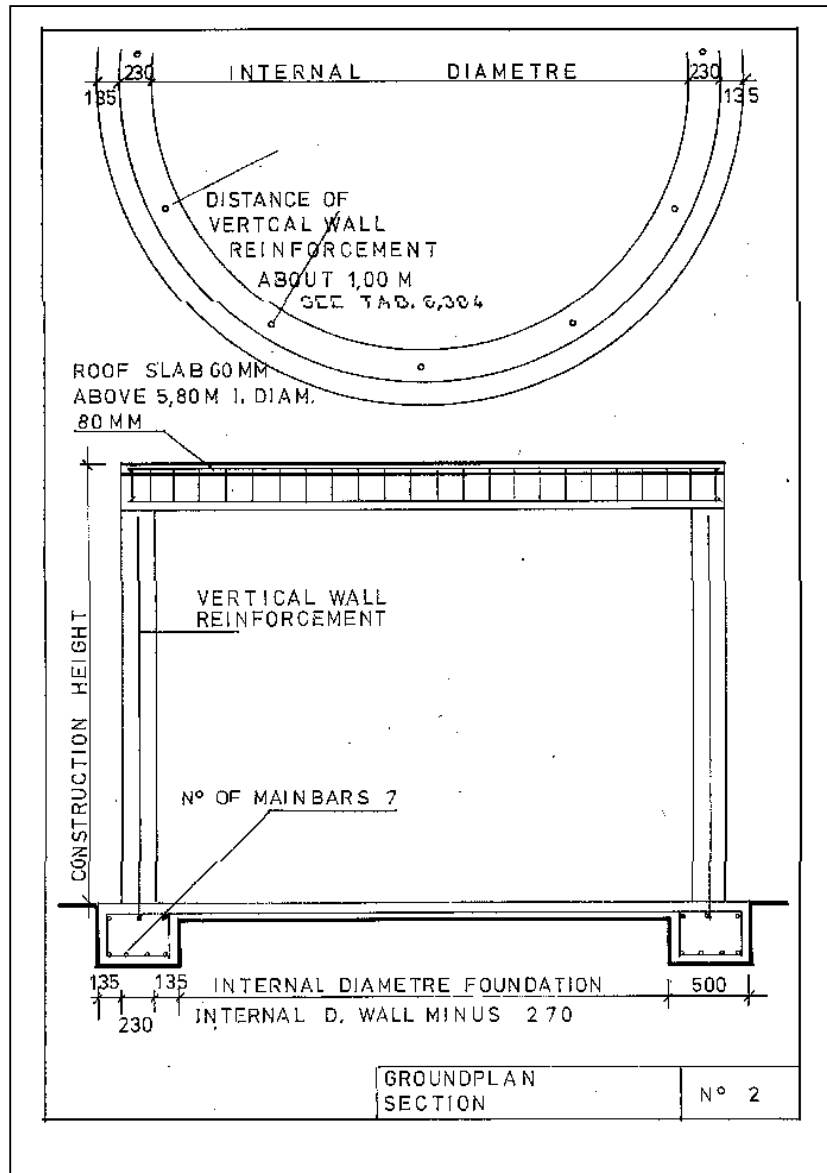

figure

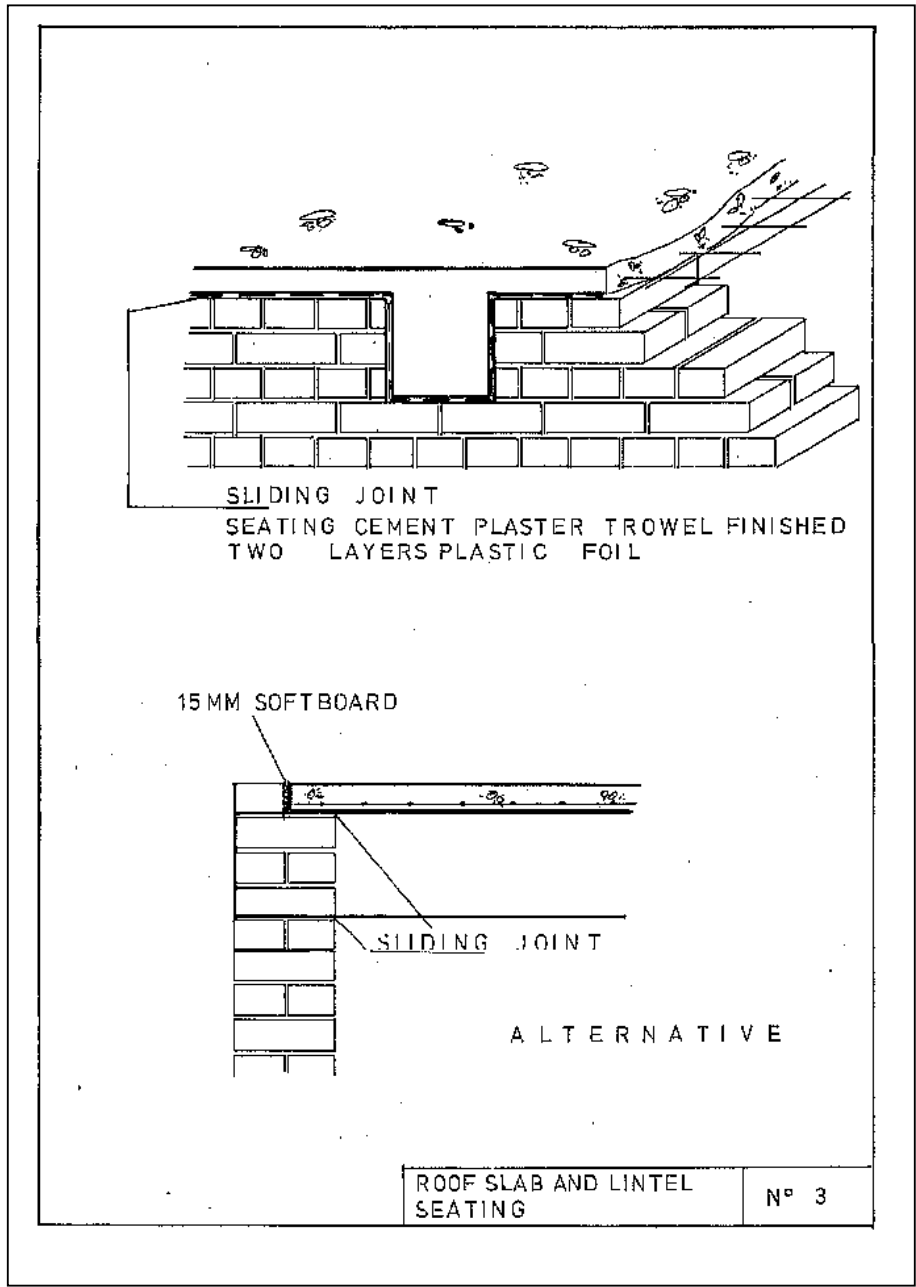

figure

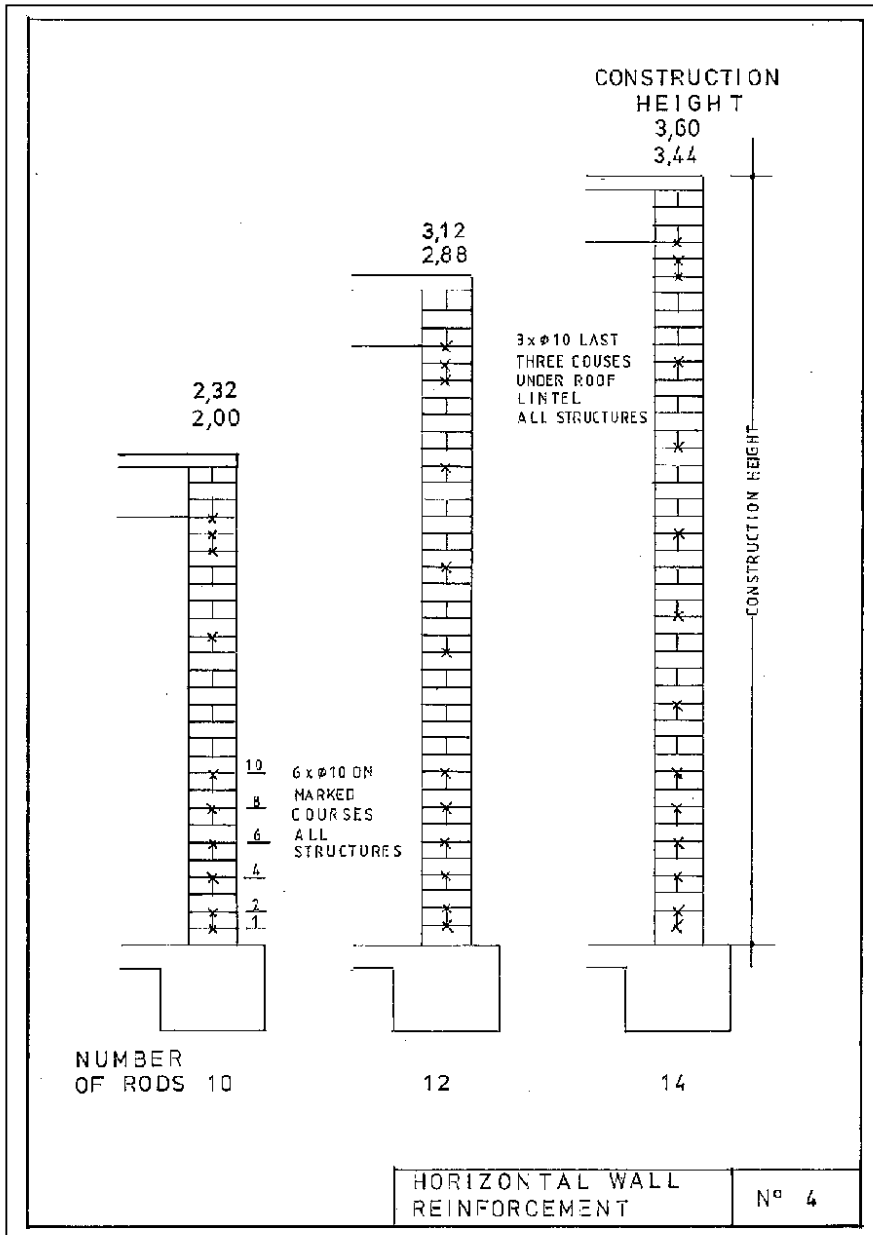

figure

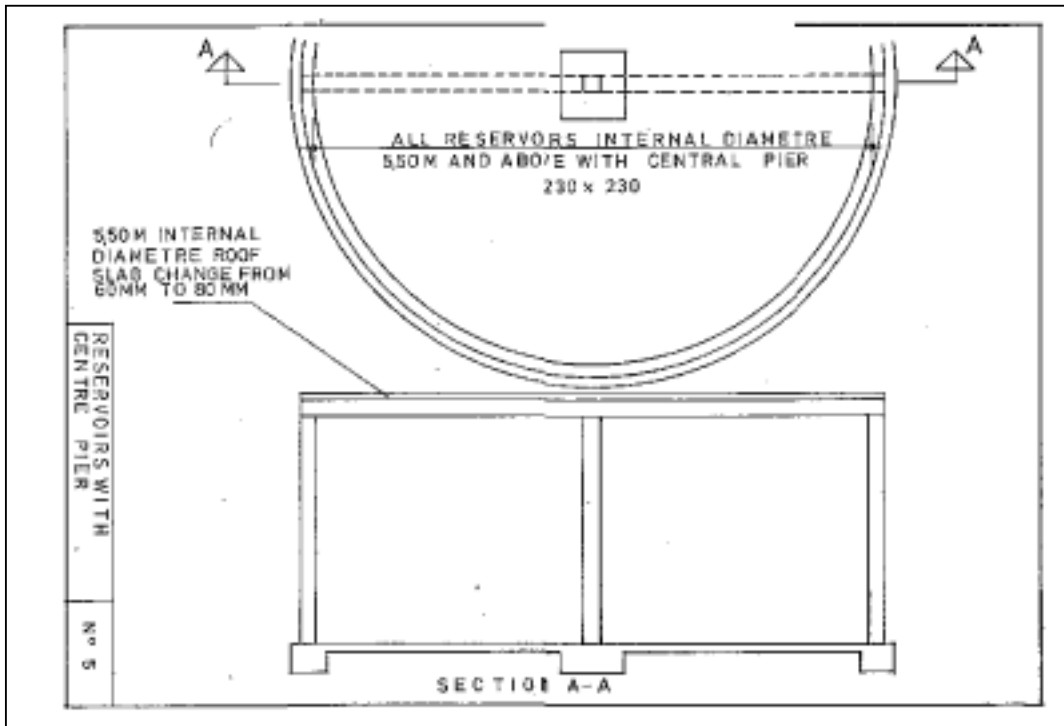

figure

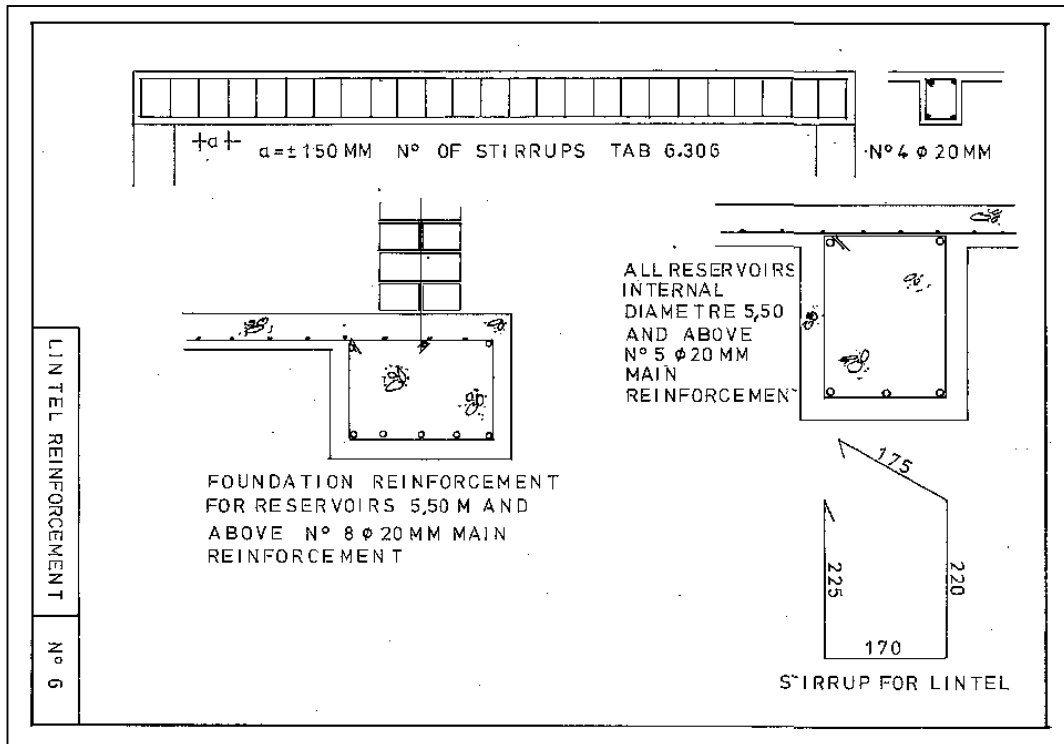

figure

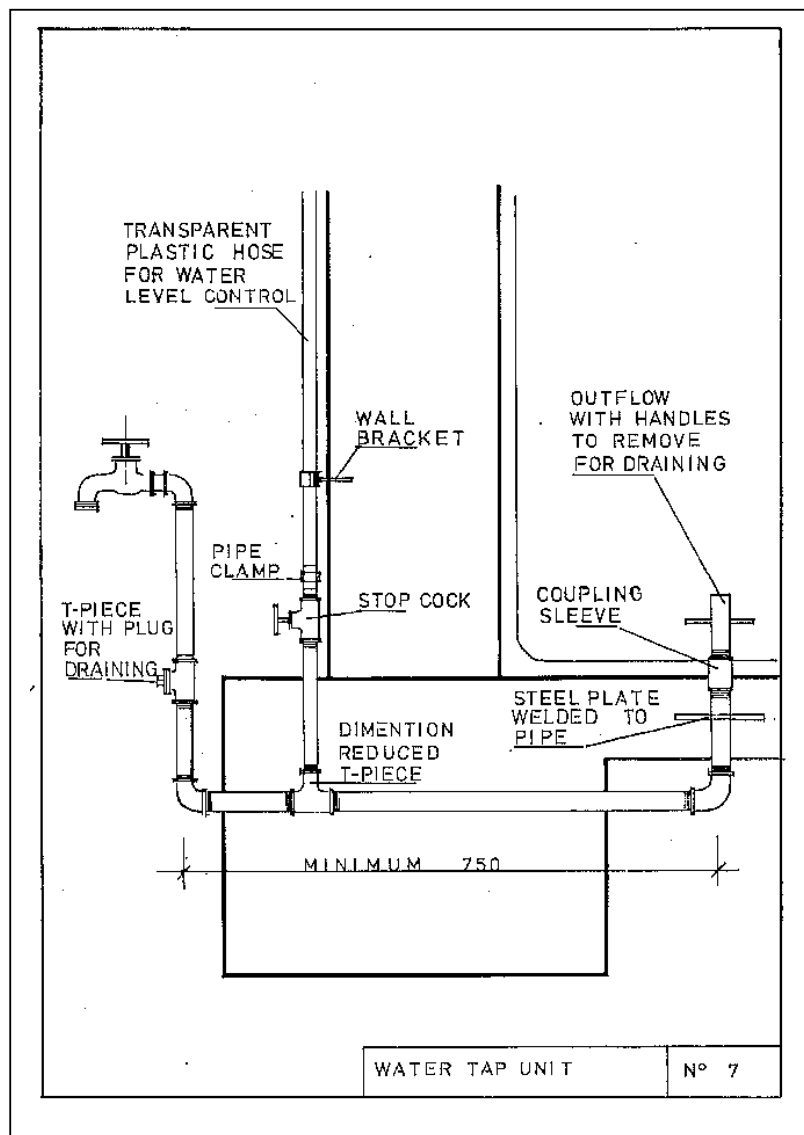

figure

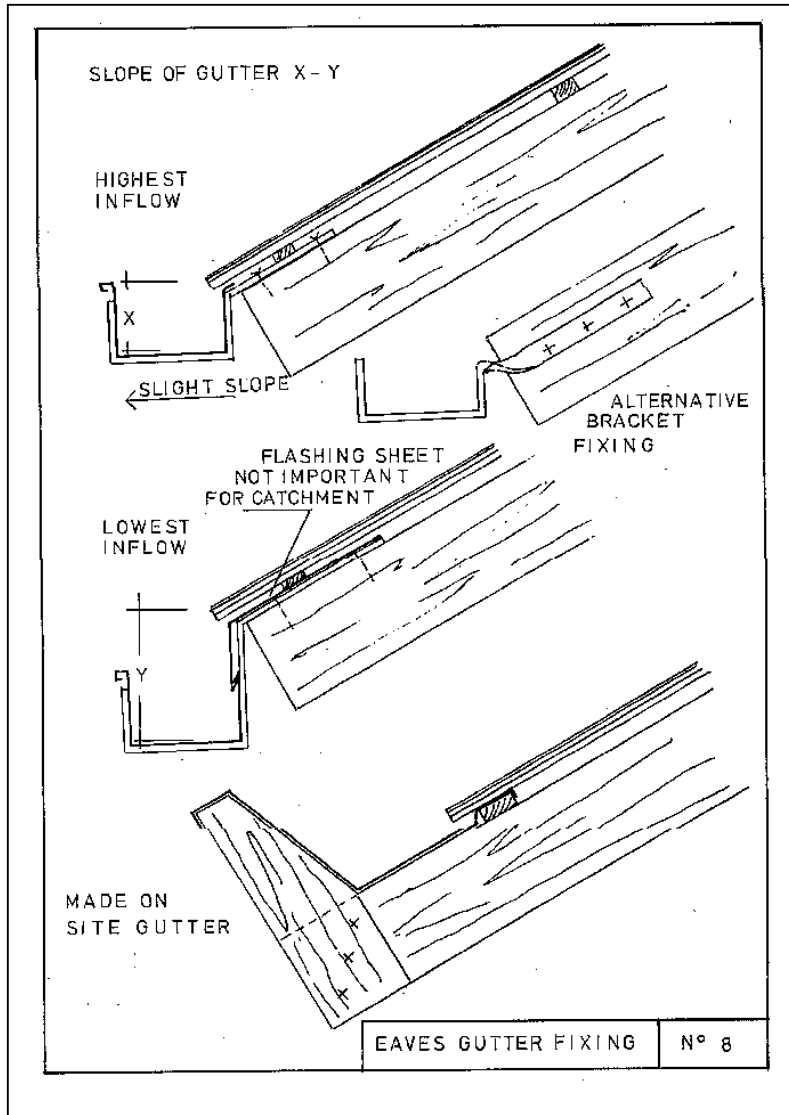

figure