

MINISTRY OF AGRICULTURE NATURAL RESOURCE SECTOR



GUIDELINE ON IRRIGATION AGRONOMY



Ministry of Agriculture



MASHAV
Israel's Agency for International
Development Cooperation
Ministry of Foreign Affairs





Published by

Natural Resources Management Directorate, Natural Resource Sector and the Ministry of Agriculture, Ethiopia. This publication has been supported by Deutsche Gesellschaft für Internationale Zusammenarbeit (GIZ) GmbH on behalf of the German Government.

Material in this publication may be freely quoted or reprinted with acknowledgment.

Contributors:

Hussein Kebede (MoA, NRMD) and Ermias Birru (GIZ, SSI- PMU)

Scanned pictures:

Hussein Kebede

Ordering Information

To order copies please contact:

Ministry of Agriculture

Natural Resources Management Directorate

P.O.Box 62347

Addis Ababa

Ethiopia

Tel.: +251-1-6462373

Fax: +251-1-6462366

E-mail: moard-nr@telecom.net.et

Table of Contents

PART I. PRINCIPLES AND PRACTICES OF IRRIGATION

ACKNOWLEDGEMENT.....	IV
FOREWORD.....	v
1. INTRODUCTION.....	1
2. DEFINITION AND IMPORTANCE OF IRRIGATION.....	3
2.1 Definition of irrigation.....	3
2.2 The need and importance of irrigation.....	3
3. ILL- EFFECTS OF IRRIGATION.....	5
4.OPPORTUNITIES AND CHALLENGES OF IRRIGATED AGRICULTURE IN ETHIOPIA...7	
4.1 Natural Sources of Water.....	7
4.2 Irrigation Water Sources.....	8
4.3 Opportunities for Irrigated Agriculture.....	8
4.4 Challenges and Constraints to Irrigated Agriculture.....	11
5. SOIL- PLANT- WATER RELATIONSHIPS.....	13
5.1 Soil Physical Properties Influencing Irrigation.....	13
5.2 Soil Moisture.....	20
5.3 Infiltration Characteristics of Soil.....	22
6. ESTIMATING WATER REQUIREMENT OF CROPS.....	26
6.1 Crop Water Requirement	26
6.2 Evapotranspiration and Consumptive Use.....	27
6.3 Factors Influencing Evapotranspiration.....	28
6.4 Estimating Reference Crop Evapotranspiration (ETO).....	31
6.5 Effective Rainfall.....	40
6.6 Irrigation Requirement.....	42
7 METHODS OF IRRIGATION.....	45
7.1 Classification of Irrigation Methods.....	45
7.2 Surface Irrigation Methods.....	45

7.3 Sprinkler Irrigation.....	53
7.4 Drip Irrigation.....	55
7.5 Selection Criteria for Suitable Irrigation Methods.....	57
8. ENHANCING IRRIGATION WATER USE EFFICIENCY.....	58
8.1 Enhancing Irrigation Efficiency in the Abstraction and Conveyance Systems.....	58
8.2 Applying of Improved on-farm Water and Crop Management.....	63
9. IRRIGATION SCHEDULING	65
9.1 Factors Affecting Irrigation Scheduling.....	65
9.2 Criteria for Irrigation Scheduling.....	70
9.3 Frequency and Interval of Irrigation.....	72
9.4 Determination of Irrigation Scheduling for Major Irrigated Crops.....	76
10. MEASUREMENT OF IRRIGATION WATER.....	84
10.1 Methods of Mater Measurements.....	84
10.2 Procedures of Water Measurement in an Open Channel.....	86
11. IRRIGATION WATER QUALITY.....	90
11.1 Sources of Salinity.....	91
11.2 Types of Salt Affected Soils.....	91
11.3 Salinity Problems.....	93
11.4 Salinity Effects on Crops.....	94
11.5 Methods of Overcoming Salinity Problems.....	95
12. IRRIGATION AND CROPPING PATTERN.....	102
12.1 Factors Governing Cropping Patterns.....	102
12.2 Developing Cropping Pattern.....	107
13. IRRIGATION AND FERTILIZER USE.....	109
13.1 Synergism of Irrigation and Fertilizer Use.....	109
13.2 Water and Nutrient Availability in the Soil.....	109
13.3 Nutrient Losses.....	110
13.4 Nutrient Uptake and Use in Irrigated Condition.....	110
13.5 Water and Fertilizer Response.....	111
13.6. Factors Affecting Fertilizer Use.....	112
13.7 Determination of Fertilizer Needs.....	113
13.8 Efficient Use of Fertilizers.....	115

PART II. IRRIGATION AGRONOMIC PRACTICES IN MAJOR IRRIGATED CROPS

1.Cereals.....	122
1.1 Maize	122
1.2 Wheat.....	132
Oil seeds.....	140
2.1 Groundnuts.....	140
3 Vegetables.....	147
3.1 Guiding principles and practices for successful growing of vegetables.....	148
3.2 Selected vegetable crops.....	159
3.2.1 Onion.....	159
3.2.2 Tomato.....	167
3.2.3 Pepper.....	178
3.2.3 Cabbage.....	183
4 Tuber crops.....	189
4.1 Potato.....	189
4.2 Sweet potato.....	198
5 Irrigation practices in some fruit crops.....	204
5.1 Banan.....	204
6 References.....	215

PART III. Annexes

Annex I. Irrigation methods and intervals of major irrigated crops.....	216
Annex II. Planting distance and optimum plant population of major irrigated crops.....	257
Annex III. Crop coefficient for different crop growth stages and seasonal crop water requirements.....	217
Annex IV. Approximate duration of crop growth stages for various field crops.....	218
Annex V. Tables to be used in the calculation of ET ₀ using the modified Penman method /Tables 29- 36/.....	218-220
Annex VI. Pan- coefficient for class- A pan for different ground cover and level of mean RH and 24 wind run.....	220-221
Annex VII. Climatic, soils and water requirements for major irrigated crops.....	222
Annex VIII. Nutrient composition of vegetable crops per 100 g edible portion.....	222-223
Annex IX. Evapotranspiration rate of certain areas of the country.....	223
Annex X. Root depth of major irrigated crops.....	223-224
Annex XI. Fertilizer recommendations for major cereal crops.....	224
Annex XII. Fertilizer calibration.....	225-228

Acknowledgements

The preparation of the current guideline is basically based on the earlier irrigation agronomy manual prepared by the former Crop Development Department with the former Ministry of Agriculture and Rural Development. Of course, most of the materials for the previous and current guidelines are contributed by Hussein Kebede who worked in the past as senior irrigation agronomist with the former Crop Development Department and currently working as senior agronomist with the Natural Resources Management Directorate with the Ministry of Agriculture. Therefore, the Natural Resource Sector is expressing its appreciation for the significant contribution made by Hussein Kebede in this regard. Similarly, part one of the guideline, which focused on principles and practices of irrigation is further edited by Ermias Birru who is currently working with GIZ-SLMP as senior irrigation and infrastructure advisor, particularly working for Enhancing Irrigation Efficiency and Water Management Project, contributed significantly for the improvement of the guideline in its present form for which the Natural Resource Sector is also quite grateful.

Of course, the guideline is improved significantly and updated based on practical field experiences and using the research findings obtained from the Ethiopian Institute of Agricultural Research in the area of on-farm irrigation water and crop management practices for which we are also extending our appreciation.

The Natural Resources Management Directorate would like to extend its acknowledgement to GIZ – SLM Programme Coordinating Office, Addis Ababa for the financial support provided for publishing the guideline through a trilateral project, Enhancing Irrigation Efficiency and Water Management-EIE.

We are also grateful to the contribution of various professionals who had worked in the past with the MoA in the area of irrigation and actively participated in the development of similar technical guidelines on which the current guideline is based on and even though the present form of the guideline is presented in a more comprehensive and elaborated manner.

The publication of the guideline has been materialized with the assistance of GIZ-SLMP and the Natural Resource Sector acknowledges the supporting staff of GIZ in general and in particular, our appreciation goes to Ato Alemayehu Zewdie for the close follow up and facilitating role in order to effectively handling the publishing activity. However, the contents of this guideline are the sole responsibility of the Natural Resources Sector and by no means be taken to reflect the views of GIZ-SLMP.

Foreword

The preparation of this Irrigation Agronomy Guideline is timely and focuses on improved on-farm water and crop management practices that have significant importance to enhance irrigation efficiency and increase crop production and productivity of irrigated agriculture. Of course, traditional small-scale irrigation development in Ethiopia has a history of antiquity; while “modern” irrigation development was started only in the 1950s’ by the expansion of commercial irrigated farms established in the Awash Valley through the joint venture of the then Government of Ethiopia and a foreign company. However, the irrigation sub-sector has not yet developed and thus, is not contributing its share to the overall economic development of the country as required, due to different constraints. Limited availability of improved irrigation technologies, limited trained manpower, inadequate capacity and skills in the area of irrigation and inadequate extension services are among the major production constraints that impede irrigation development. Hence, considering this fact the Federal Democratic Republic of Ethiopia has given top priority to the irrigation sub-sector in the National economic development plan with the ultimate objective of enhancing agricultural production and productivity in general and crop production in particular thereby improving the food security situation of the country.

Therefore, Irrigation is generally considered as a means of modernizing the country’s agricultural economy and is an important investment for improving the rural income through increased agricultural production and productivity. It is also central for reducing the ever increasing pressure on land, especially up in the highlands primarily by increasing the productivity per a unit of land and to some extent by bringing new land under cultivation, particularly in the lowlands where population density is relatively lower and uncultivated land is abundantly available. Moreover, irrigation plays an important role in combating the effects of recurrent droughts and sustains production with efficient and effective use of the available resources; namely, water and land in order to primarily alleviate the problem of food insecurity, improve nutritional status of the rural population and in the long-run to achieve the bigger picture of alleviating poverty. It is through irrigation and integrated crop management that sustainable crop production can be ensured.

Water centered development is taken as a key strategy both for adaptation to the impacts of climate change and insuring of food security. The Ethiopian government, considering the potential of irrigation sub-sector including water harvesting in improving the availability of water for different uses, particularly in drought-prone areas of the country, is exerting its maximum efforts and significant achievements have been recorded. However, there are also constraints and challenges being faced in implementing irrigation technologies. The major production constraints that impede the development of the irrigation sub- sector among others are predominantly primitive nature of the overall existing production system,

shortage and increased price of agricultural inputs and limited availability of improved irrigation technologies, limited trained manpower, inadequate capacity and skills in the area of irrigation, inadequate extension services, particularly in irrigated agriculture and losses of stored water through seepage and evaporation.

Therefore, this Irrigation Agronomy Guideline is prepared with the prime objective of making the information available primarily for regional, zonal and woreda irrigation agronomists and even the manual can be used by DAs to improve their theoretical knowledge base and upgrade their practical skills for providing efficient and effective technical assistance to farmers engaged in irrigated agriculture. The manual is subject to periodical revision to enrich it with practical field experiences and new research findings.

Therefore, readers of this guideline are advised to use the guideline as a learning tool and a practical guide, which could be further enriched through practical field experiences considering the specific situation of their respective working areas.

A handwritten signature in blue ink, appearing to be 'Sileshi Getahun', written in a cursive style.

Sileshi Getahun
State Minister, Ministry of Agriculture

PART I.

PRINCIPLES AND PRACTICES OF IRRIGATION

1. INTRODUCTION

Agriculture is the leading sector in the national economy of Ethiopia, accounting for about 46% of GDP, while contributing almost 90% of export earnings and employing 85% of the population. The country is endowed with a wide range of natural resources such as land, irrigation potential and agro-ecological diversities suitable for the growing of various crops and need prime consideration and a more systematic utilization in order to bring a sound change and sustainable growth in the agriculture sector, which positively contributes for the overall economic development of the country.

The predominant agricultural system is based on smallholder production and the sub-sector for crop production is entirely dependent on rainfed agriculture with very limited areas currently developed under irrigation. The agriculture sector is facing a great challenge of not fulfilling the food requirement of the nation and the country is forced to depend on foreign food aid in order to feed its people accordingly.

The irrigation potential of the country is estimated to be about 3.7 million hectares, of which about 20 to 23% is currently utilized (PASDEP, 2009/10, MoA), even there is no consistent inventory with regard to the developed area under irrigation both traditional and modern irrigation schemes. The major production constraints that impede the development of the irrigation sub-sector among others are predominantly primitive nature of the overall existing production system, shortage and increased price of agricultural inputs and limited availability of improved irrigation technologies, limited trained manpower, inadequate capacity and skills in the area of irrigation, inadequate extension services, particularly in irrigated agriculture.

Therefore, the importance of irrigation development, particularly in the peasant sub-sector needs prime consideration to raise production to achieve food self-sufficiency and ensure food security at household level in particular and at country level at large. The irrigated agriculture can also play a vital role in supplying with sufficient amount and the required quality of raw materials for domestic agro-industries and increase export earnings. In recent years there are a large number of small-scale irrigation schemes that have been developed in different parts of the country by the Government and support of different funding agencies. However, due to different environmental and management factors most of these small-scale irrigation schemes are not being exploited fully and irrigation, in general is not contributing its share to the overall economic development of the country as required. Hence, the irrigation sub-sector has to be given top priority in the overall development plans of the country with the ultimate objective of enhancing agricultural production and sustain crop production and alleviate food insecurity problems.

This irrigation agronomy training manual is mainly prepared with the prime objective of making the information available primarily for regional irrigation agronomy experts and even the manual can be used by Woreda experts to enhance their theoretical knowledge and upgrade their practical skills in providing efficient and effective technical assistance to farmers engaged in irrigated agriculture. The manual is subject to periodical revision to enrich it with practical field experiences and new research findings.

The manual is designed in such a way as to deliver some basic and useful information to

the readers. In part one of the manual main emphasis is given to principles and practices of irrigation, of which importance of irrigation, ill- effects of irrigation, sources of irrigation water, opportunities, challenges and constraints to irrigated agriculture in Ethiopia, soil- plant- water relationship, irrigation methods, options for enhancing irrigation water use efficiency, irrigation scheduling, irrigation and cropping pattern, irrigation and fertilizer use are given prime consideration. In part two of the manual included irrigation agronomic practices for major irrigated crops, in which specific coverage of soil and climatic requirements of each crop, recommended varieties for production, improved cultural practices, crop protection measures and harvesting procedures are discussed in detail. At last, annexes are attached to be used as references

2. DEFINITION AND IMPORTANCE OF IRRIGATION

Module 1

Objectives:

- **After reading this chapter, readers and/or training participants will be able to:**
- **clearly define what irrigation means and describe its need and importance;**
- **describe its economic importance and role in the national economic development plan.**

2.1 Definition of irrigation

Irrigation is defined as an artificial application of water to irrigated crop fields to supplement the natural sources of water to satisfy the crop water requirements and increase crop yields on sustainable basis without causing damage to the land and soils. The natural supply of water to the agricultural land for crop production purpose is usually received from natural sources such as precipitation /rain/, other atmospheric water, ground water and floodwater. But the fact is that in many parts of the world including Ethiopia, the amount, frequency and distribution of rainfall, which is the principal source of water for crop production, is becoming more unpredictable and inadequate. Furthermore, the rainfall nature may be insufficient and untimely, and the ground water may be too deep in the soil profile beyond the active root zone, which is unavailable to the plant roots. This is a common phenomenon in drought- prone areas of the country and successful crop production in these areas is only possible with the support of irrigation.

Irrigation itself is a key input for successful and sustainable crop production. Irrigation water management is strictly combined with improved agronomic practices for increased yields of irrigated crops. In this context, irrigation agronomy simply defined as a branch of agriculture and biology that explores the principles and concepts of plants- soils- water relationships combined with other improved crop management practices to optimize production on sustainable basis without causing damage to the environment. Therefore, maximum benefit of using improved crop production technologies such as high yielding varieties, optimum fertilizer use, establishing multiple cropping systems, improved cultural practices and appropriate plant protection measures can only be achieved when adequate supply of water is assured. On the other hand, optimum benefit from irrigation can be obtained only when the required inputs are available on time and applied properly in a more integrated manner with other technologies.

2.2 The need and importance of irrigation

Irrigation is considered necessary when the natural supply of water is not sufficient to satisfy the crop water requirements for sustaining crop production. Therefore, the water deficit should be supplied by supplemental or full irrigation. Inadequate and uneven distribution of rainfall, with adequate but uneven distribution throughout the growing season, the need to sustain the practice

of double cropping in the dry season, and ensuring of growing of high value crops are among the factors that necessitate irrigation.

Irrigation plays an important role in the development of the agriculture sector and contributes much in the national economic development of the country. Therefore, irrigation ensures production of high value crops, ensures protection of crop failures, due to drought; ensures cultivation of suitable multiple cropping practices in a season, maximizes the value of land and farmers may become prosperous and their living standard could be raised and creates an opportunity of introducing aquaculture to farmers that will improve their diet by supplementing with protein source and can be used as an additional income source. In addition, irrigation water can be used for domestic and industrial water supplies for nearby areas and Irrigated agriculture requires increased farm labours and this creates employment opportunities for the rural population.

Module 2

Objectives:

After reading this chapter, readers and/or training participants will be able to:

- **describe the ill- effects of irrigation and their impacts on the environment and human health;**
- **better understand the importance of enhancing efficiency of on- farm water management**

Irrigation is useful only when it is properly managed and controlled. Faulty and careless irrigation water management practices do harm to crops and damage the land and ultimately reduce crop yields. Besides, excess watering is a waste of the valuable and scarce resource- the water. Traditionally, including the Ethiopian experience when water is excessively available, farmers are usually tempted to over- irrigate their lands without being conscious of the harmful effects of over-watering on their fields.

Therefore, the following are some harmful effects of faulty and excess irrigation practices:

- **Poor soil aeration:** Excess irrigation fills the pores with water expelling soil air completely and this leads to deficiency of oxygen, which affects the root respiration and normal growth of crop plants.
- **Increase nutrient toxicity level to crops:** In excess water application nutrients such as manganese and iron become more soluble and their increased availability may be toxic to plants.
- **Creates physiological imbalance in plants:** Physiological activities of plants will seriously be affected, due to lack of adequate oxygen in poorly aerated soil.
- **Restricts the root system:** Lack of adequate oxygen, restricts the root development. Roots do not grow well in wet soil conditions and usually remain shallow and affects the nutrient uptake of plants that ultimately affect crop growth and resulted in reduced crop yields.
- **Increases soil erosion and lead to degradation of soil fertility status:** Heavy irrigation in areas of sloping and undulating lands may cause erosion of surface soil. The stream size and amount of irrigation water applied should be decided based on the water intake rate, hydraulic conductivity, textural class and water retentive capacity of the soil, land slope and soil water depletion status in order to minimize the likely erosion hazard and leaching of nutrients beyond the active root zone.
- **Rise of water table:** Faulty and over- irrigation in a farm, if continued for a long period leads to rise of water table. The rise of water table restricts the root development and limits the feeding zones of crops. Growing of fruit trees and deep- rooted crops in areas, where the water table rises high up and gets near the soil surface, is not suitable. Instead, shallow

rooted- crops are recommended to be cultivated in such conditions.

- **Creates water logging:** When irrigation is done in a large stream size and if not turned off in the proper time, excess water accumulates in the lower part of the field and causes water logging. The water logging further destroys the crumb structure and soil aggregates and encourages the development of platy structure, which is not suitable for crop production. Therefore, controlling of the stream size and constructing of drainage systems is highly essential to drain out excess water and create favorable conditions for normal growth and development of crop plants.
- **Affects activities of micro- organisms:** Useful aerobic bacteria such as ammonifying, nitrifying and nitrogen fixing bacteria cannot function well under deficiency of oxygen. As a result, decomposition of organic matter, atmospheric nitrogen fixation and availability of nutrients to plants are hampered. On the other hand, anaerobic bacteria are activated causing loss of nitrogen in the form of gas, evolution of harmful gases and encourages incidence of plant diseases.
- **Increases incidence of malaria and other water borne diseases:** Waterlogged areas are ideal sites for breeding of mosquitoes and enhance the outbreak of malaria and water borne diseases. Therefore, basic knowledge and skills are required for efficient water management practices.

Module 3

Objectives:

After reading this chapter, readers and/or training participants will be able to:

- define the sources of irrigation water in Ethiopian context;
- understand the potential opportunities and challenges of irrigated agriculture in Ethiopia.

Crops are getting water from natural sources and through irrigation. Natural sources supply the largest part of the water required by crops in most of the places, particularly in humid climates. The natural sources are inexpensive as no cost is involved in their exploitation and application. However, crop yields are fluctuating significantly when crop production system is entirely depend on rainfall, due to unpredictable nature of rainfall, which is in most cases inadequate in its amount and uneven distribution throughout the crop-growing period. This necessitates irrigation to supplement the crop water need by irrigation.

4.1 Natural Sources of Water

Precipitation, atmospheric waters other than precipitation (such as dew, fog, cloud and atmospheric humidity), ground water and floodwater are natural sources of water for crop production. However, their contribution to crops varies depending on their amount and availability throughout the season. Each of the natural sources of water is discussed in more detail as follows for better understanding and designing of more appropriate and wise use of the resources.

Precipitation: The primary source of water for agricultural production, for large parts of the world, including Ethiopia is rainfall or precipitation. Rainfall is characterized by its amount, intensity and distribution in time. Precipitation is the most important part of natural sources of water for crop plants and rain is the largest part of it, snow also contributes significant portion in temperate regions. In humid and sub-humid areas where rainfall is moderate to high crops are grown depending mainly on rain and the water requirement of crops is fully met from this source. However, in moisture deficit areas, when irrigation water is available part of the water need of crops are met from irrigation.

Atmospheric water other than rain: Atmospheric water, which is consisting of dew, fog, cloud and atmospheric humidity, also serves a very minor contribution in supplying water for crop plants. Though their contribution to water needs of crops is negligible, particularly in Ethiopian condition, their role to make some water available to crop plants cannot be overlooked. These sources of water are quite effective in reducing evaporation from soil surface and transpiration by plants owing to reduction in atmospheric demand.

Ground water: Ground water is the water found beneath the ground surface and considered as the second main source of water for crop plants. When water table rises and comes near the crop roots, crop plants utilize a considerable amount of ground water and that cuts down the irrigation requirement of crops. However, deep- rooted crops can exploit the maximum and benefit from deep water table.

Floodwater: Floodwater is generally, used for growing of crops during the main rainy season by diverting seasonal floods to crop fields. After the flood recedes, crops are grown in the field and give good yields. This is a common practice in drought- affected areas and utilizing the seasonal flow of rivers by diverting them to cultivated fields and growing low water demanding and drought tolerant crops, which have significant values in improving the household food security situation in drought- prone areas.

4.2 Irrigation Water Sources

Irrigation supports successful crop growing and stabilizes crop yields. Irrigation is required in most of the places having uncertainty and uneven distribution of rainfall, particularly in semi- arid and arid regions. Irrigation, however, involves high capital investment for its exploitation and supply to crop fields. Irrigation water is obtained mainly from two sources: Surface water and ground water.

4.2.1. Surface water

In general, rain, melting snow, rivers, lakes, reservoirs, water tanks and ponds are the main sources of surface water. However, in the Ethiopian context, melting snow is not considered as part of the main source of surface water. The surface water provides the largest quantity of irrigation water. Dams are constructed across rivers and water is diverted to agricultural fields through canals and distributed by gravity flow. Streams are developed and the water is led to fields under gravity to irrigate crops.

4.2.2. Ground water

Ground water is also an important source of irrigation water. Rain and melting snow are the principal sources for recharging ground water. However, rain is considered as the main source for recharging ground water in the Ethiopian condition. Besides, seepage water from canals, reservoirs and lakes, rivers drainage and percolating floodwater recharge also the ground water. Ground water is an ideal water source provided that there is an adequate recharging potential.

4.3 Opportunities for Irrigated Agriculture

4.3.1 Water resources

Ethiopia has a vast water resource potential and the Ethiopian highlands are the source of many of international rivers like that of the Blue Nile and Wabe Shebelle draining into the neighboring countries. The country has 12 major river basins, two of which are dry /Aysha and Ogaden/ and several lakes and wetlands. Integrated development master plan studies and related river basin surveys of the 1990s indicate that the total surface water resource potential of the country is about 122 billion cubic meters (m³). Most of these surface water resources are draining out to the territory of the neighboring countries as run- off, which is benefiting them significantly and

only 8- 10% of the available surface water remains within the country. Only about 4 to 5% of the potential of the surface water resource is used for irrigation. The second main source of water is the ground water, which is estimated at 2.6 billion m³. This source of water is not yet exploited fully. Ethiopia has several lakes (about 7, 000 km²), a number of saline and crater lakes as well as several wetlands. Most of the lakes, except Lake Tana, which is located in the northwestern part of the country, are located within the Rift Valley. Among these lakes only Ziway has fresh water, which is suitable for irrigation, while others are saline. Considering the water potential of the country promotion of both small- scale and large- scale irrigations can play major roles in the development of the agriculture sector in particular and the national economy at large.

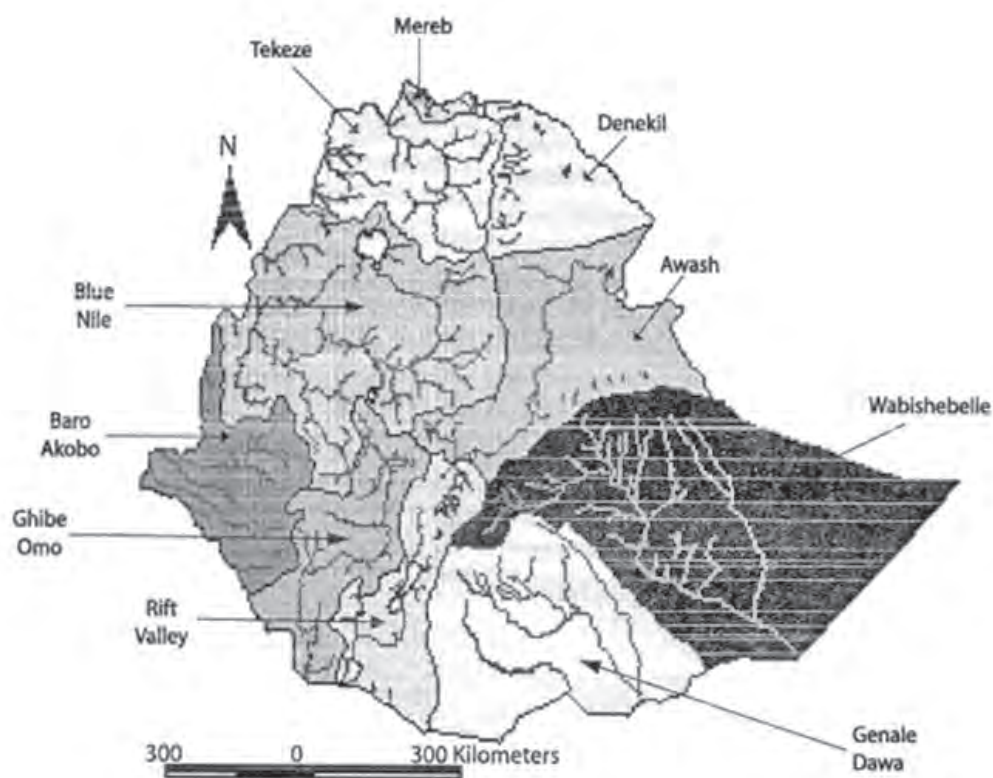

Figure1. Water resource basins of Ethiopia (adopted from IWMI Working paper 98. 2005, Addis Ababa, Ethiopia)

4.3.2 Soil and climatic conditions

Ethiopia has diverse soil types suitable for the growing of different crop species and obtains optimum crop yields. In addition, the country has a tropical monsoon climate with wide topographic- induced variation. In general, three climatic zones can be distinguished: a cool zone consisting of the central parts of the western and eastern section of the high plateaus, a temperate zone between 1,500 and 2,400 m above seas level, and the hot lowlands below 1,500 m. The mean annual temperature varies from less than 7- 12 °C in the cool zone to over 25 °C in the hot lowlands

and the mean annual potential evapotranspiration varies between 1,700- 2,600 mm in arid and semi- arid areas and 1,600- 2,100 mm in dry sub- humid areas.

In Ethiopian condition, rainfall is the most important part of the natural sources of water that contributes significantly to the increased flow of surface water sources and the principal sources for recharging ground water. The average annual rainfall for the country is estimated about 800 mm, varying from about 2,000 mm over some pocket areas in southwest Ethiopia to less than 100 mm over the Afar lowlands in the northeast of the country. The rainfall, generally, characterized with erratic nature and uneven distribution throughout the crop-growing period.

4.3.3 Land resource

The country's total land area is about 1.12 million km². Of which, the potential area for irrigated agriculture is estimated to be about 4.25 million hectares. This potential figure is liable to change when the master plan studies of all the remaining river basins are completed and this potential area could be raised up, if cultivation is planned using pressurized irrigation systems using the land up to 12- 14 % slope. Irrigation in Ethiopia dates back several centuries, while the "modern" irrigation development was started by the commercial irrigated farms established in the early 1950s through the joint venture of the Government of Ethiopia and the Dutch company in the Awash Valley.

4.3.4 Irrigation technologies

Most of the irrigated land is supplied from surface water sources, while ground water use has just been started on pilot phases in east Amhara, Southern Tigray and in the Rift Valley areas. Surface irrigation methods are dominated throughout. However, sprinkler irrigation system is being practiced on about 2% of the irrigated area for sugarcane production in Fincha State farms, in Southern Tigray and Eastern Amahara under subsistence farmers. Similarly, it is being introduced in localized areas in the Rift Valley (Oromia). Drip irrigation technologies are also being promoted in Southern Tigray, Eastern Amhara, Rift Valley areas and under commercial farms within the Rift Valley areas.

Local factories are coming up and actively engaged in manufacturing irrigation technologies and improved farm implements, which could be considered as a promising step in strengthening the irrigation sub- sector.

4.3.5 Labour availability

Irrigation requires intensive labour works and the availability of the required labour force throughout the season is very crucial for successful production. Irrigation as compared to rainfed agriculture requires more skilled labour and basic know- how of the main operational activities to fulfill the operations at optimum level. Labour availability is very vital for running irrigation activities effectively and efficiently in order to fulfill operational activities at optimum time and establish a more profitable enterprise to get the maximum benefit out of it. In this regard, the required labour forces for successful production exist in Ethiopia as compared to other countries. This can be considered as one of the attractive element that could be taken into account to invest in the irrigation sub-sector. In rural areas even there is an opportunity as well to train educated youth to actively participate in providing technical maintenance services for irrigation equipment and pumps, which is crucial in some places and smallholder users are forced to get the required services at distant areas.

4.4 Challenges and Constraints to Irrigated Agriculture

Ethiopia is experiencing a rapid population growth (about 2.9% per annum) and the great challenge is that the growth of the agriculture sector is not proportional with the rate of the population growth and as a result the sector is unable to fulfill the food requirements of the whole nation and even not satisfying the need of domestic industries in supply of raw materials with the required quantity and quality of produce. Similarly, the country is not earning foreign exchange as it is supposed to be persuaded. Crop production is mostly dependent on rainfed agriculture, which is characterized at the same time with low crop yields, due to erratic and uneven distribution of rainfall throughout the growing period and even crop failures are being the common phenomenon, particularly in some drought-prone areas of the country. This fact can bring irrigation to the forefront in the national economic development plan of the country and this indicates that there is a great need of strengthening the national capacities and technical capabilities in the irrigation sub-sector to make the best use of the available water and land resources for improving the irrigation systems and increase the role of irrigated agriculture in the development of the agriculture sector in particular and the overall economic development of the country in general. Therefore, considering the importance of the sub-sector, it will be vital to bring the entire concerted efforts of all stakeholders to implement more appropriate and integrated water resources development to bring sustainable socio-economic development of the country and alleviate food insecurity related problems and sustain crop production.

Despite, the vast potential of irrigated agriculture in the country, only about 20 to 23% (853,000 ha) of the potential (3.7 million ha) is currently irrigated, including both traditional and modern irrigation schemes as per the recent crude data collected from regions (PASDEP, 2009/10, MoA). This shows that the irrigation sub-sector is contributing little towards the development of the national economy. Over 90% of agricultural production depends on rainfed agriculture, which is also facing serious challenges and constraints that unable to produce sufficient production to fulfill the food requirements of the whole nation. This indeed, the importance of irrigation in the overall economic development of the country and practical demonstrations have been observed that through irrigation there is a possibility to attain agricultural surpluses enough to satisfy the need for domestic consumption and for external markets, of course with the required quality of produce. Therefore, the irrigation sub-sector need to be supported by appropriate irrigation technologies and related research findings that would assist farmers engaged in irrigated agriculture to increase production and productivity of irrigated crops, particularly giving priority to high economic value crops in order to bring sound economic advantage and alleviate food insecurity problems increase their incomes.

However, the reality is that the irrigated agriculture is still in its infancy stage and facing critical challenges. The following are among the major challenges and constraints:

- Inadequate emphasis given for setting up of appropriate institutional arrangements at all levels to provide more effective and efficient services to the users in irrigated agriculture;
- Inadequate infrastructural development such as roads for transportation of inputs and agricultural produce and other transport facilities, poor access to input and output markets, etc;
- Inadequate support in input supply and distribution systems and credit facilities,

- Increased input prices that are not affordable to subsistence farmers’;
- Shortage of agricultural inputs and limited availability of improved irrigation technologies,
- Low level of know- how and limited practical skills of farmers in irrigated agriculture with predominated traditional and inefficient water management practices,
- Availability of limited trained manpower and inadequate capacity in providing effective and efficient extension services in irrigated agriculture;
- Increased degradation rate of natural resources- soils and vegetation cover and consequently lead to build up of siltation that would significantly affect the irrigation infrastructure;
- Limited or lack of community consultation during planning and developing of irrigation schemes;
- Limitations in skill transfer and improved irrigation agronomic practices and
- Low-level of linkage between research- extension – farmers in promoting irrigation technologies.

Module 4

Objectives:

After reading this chapter, readers and/or participants will be able to:

- describe the major properties of soils that influence irrigation regime;
- better understand and acquired skills on soil- plant- water relationships that have significant importance in irrigated agriculture;
- understand the role of water for growth and development of crops to give optimum yields

Soil- plant- water relationships are related to the properties of soil and crop plants that affect the movement, retention and use of water. The soil water both in content and potential plays an important role in sustaining agricultural production. Soil provides the room for water and soil nutrients, which are taken up by plants through their roots located in the same medium. Water contains a large amount of dissolved nutrients, which are essential for successful growth and development of crop plants. If the rainfall is not adequate for plant growth during the growing period of a crop, additional water should be supplied to the soil for plant use in the form of irrigation. Therefore, the entry of water into the soil and its retention, movement and availability to plant roots should be well known for the efficient management of irrigated agriculture.

The rate of infiltration of water into the soil, its retention, movement and availability to plant roots are all physical phenomena, related to the physical properties of soils. Hence, it is important to know the physical properties of soils in relation to water for efficient management of irrigated agriculture and maximize the benefit for increased crop production and productivity.

5.1 Soil Physical Properties Influencing Irrigation

Soil is essential for crop production as it is the basic resource from which plants derive water and soil nutrients. Soil acts as a stability medium for plant root penetration and upholding the plant. However, not all soil conditions are good enough in fertility status to support the normal growth and development of crop plants. If the soil is not in usable condition then it will be important to develop the soil and improve its fertility for normal growth in order to obtain high crop yields. Therefore, the whole crop production system focused on managing the soil through improving its physical condition and fertility status.

The physical and chemical properties of the soil will largely determine the vigour growth of plants and affecting also the capacity of a soil to hold moisture. Soil is a three phase system comprising of the solid phase made of mineral and organic matter and various compounds, the liquid phase called the soil moisture and the gaseous phase called the soil air. The main component of the solid phase is the soil particles, the size and shape of which give rise to pore spaces of different geometry.

These pore spaces are filled with water and air in varying proportions, depending on the amount of soil moisture present. The volume compaction of the three main constituents in the soil system varies widely. In general, a good agricultural soil must have a texture, or tilth that allows moisture and oxygen in adequate proportions to reach the root zone that stores water and nutrients and allows excess water to drain away. It must be workable to facilitate cultural practices such as tilling and weeding. As a general rule, when taken on volumetric basis, an average soil in good tillage will consist of 50 percent of soil minerals including humus and air and water in equal proportions of 25 percent each respectively. In addition to the three basic components of soil described above, soil usually contains numerous living organisms such as bacteria, fungi, algae, protozoa, insects and small animals, which directly or indirectly affect soil structure and plant growth.

The most important soil properties influencing irrigation are: **Infiltration characteristics** and **water-holding capacity of a soil**. Other soil properties such as *soil texture, soil structure, capillary conductivity, soil profile conditions and depth of water table* are also important soil physical properties influencing the irrigation regime and need to be given prime consideration in the management of irrigation water. The soil properties that have influence in irrigated agriculture are discussed in more details hereunder.

5.1.1 Soil profile

A soil profile is a succession of soil layers in a vertical position down into loose weathered rock from which the soil was formed. The soil layers are different in colour and composition. The nature of the soil profile greatly influences the growth of roots, recycling of organic materials, the storage of moisture, and the supply of plant nutrients. Soils range in depth, with some being very shallow and not able to support rain-fed crops because there is insufficient soil for storing water or available nutrients. The depth of the effective system (root zone) depends on both the crop and soil-profile characteristics.

In general terms a simplified soil profile can be described as follows:

- **The plough layer:** This layer has a depth of 20 to 30 cm thick, which is rich in organic matter and contains many live plant roots. This is actually the layer, which is subject to land preparation and often has a dark colour, due to high organic matter content (brown to dark).
- **The deep plough layer:** This contains much less organic matter and relatively reduced live plant roots. This layer is hardly affected by normal land preparation activities. The colour is lighter, often grey and sometimes mottled with yellowish or reddish spots.
- **The subsoil layer:** This has hardly any organic matter or live plant roots. It is not very important for plant growth, as only a few plant roots will reach it.
- **The parent rock layer:** This layer consists of rock, from which the soil is formed. This rock is sometimes called parent material.

However, the depth of the different layers varies greatly and even some layers may be missing altogether.

5.1.2 Soil particles

The majority of agricultural soils are composed of particles of minerals, which include large coarse fragments, gravel, and particles of sands of varying sizes, silt and clay. In addition, there are also materials of organic matter in all stages of decomposition. The fine soil particle is composed of sands of varying size, silt and clay. According to the International Society of Soil Science classification of soil particles, different ranges of diameters of soil particles are recognized /see Table 1/.

It is indicated earlier that soil is composed of half solids and half pore spaces filled with water and air with equal proportion each. As the soil moisture is depleted the proportion of air to water increases in which the space occupied by water will be substituted by air. In certain soils, such as heavy clay soils have smaller pore spaces, which might be occupied with water and resulted in insufficient oxygen in the soil. It should be noted that low oxygen concentration at the root zone, will affect the ability of plants to absorb an adequate supply of nutrients from the soil and consequently, will affect the crop growth and resulted in reduced yield.

The mineral particles of soil are the chief components of most soils on volumetric basis. They consist of rock particles developed by weathering or deposited in bulk by wind or water. However, the fine earth soil particles composed of sand, silt and clay with a particle diameter of 2.0 mm and less is considered in the chemical and mechanical analysis of soils, which are affecting the water holding capacity of the soil and gained primary interest in irrigated farming. In Table 1 are provided sizes of soil particles according to the International Soil Science Classification of soil particles.

Table 1. Ranges of diameters of soil particles by soil type

Soil type	Diameters of particle size, mm
Clay	< 0.002
Silt	0.002 – 0.02
Fine sand	0.02 – 0.2
Coarse sand	0.2 – 2.0
Gravel	> 2.0

Source: Irrigation theory and practice, A.M. Michael, 1978, New Delhi

5.1.3 Soil texture

The mineral particles of the soil differ greatly in size and can be classified as gravel, sand, silt and clay, depending on their size, expressed in percentages. The relative proportion of sand, silt and clay determines the soil texture. However, the proportions of the various sizes of particles in the sample are determined in the laboratory by mechanical analysis. Based on the results of mechanical analysis soil textural classes are determined and ranked in their order of increasing amount of the fine particles they contain. In this case, we can express textural classes as sand, sandy loam, loamy sand, loam, silt loam, sandy clay loam, clay loam, silty clay loam, sandy clay,

silty clay and clay. Thus, the term “Silty clay” describes a soil in which the clay characteristics are outstanding and which also contains a substantial quantity of silt.

The texture of a soil determines its water-holding capacity, which in its turn plays an important role to hold sufficient or inadequate soil moisture for plant use. If the texture of the soil dominated with more sand in its content, the soil has less water holding capacity and the moisture available for plant use is less and significant amount of water will be lost through deep percolation beyond the active root zone, which is not available for further uptake by the crop roots.

Practical field method of assessing soil texture

Take a large spoon filled with about 15- 20 ml of soil devoid of roots, etc., drip water onto the soil until it become sticky, i.e. when the soil just starts to stick to the hand. The shape to which the soil can be shaped by hand is indicative of its texture. In figure 1, illustrates the most simple but practical field method of assessing soil textures and determining of their characteristics.

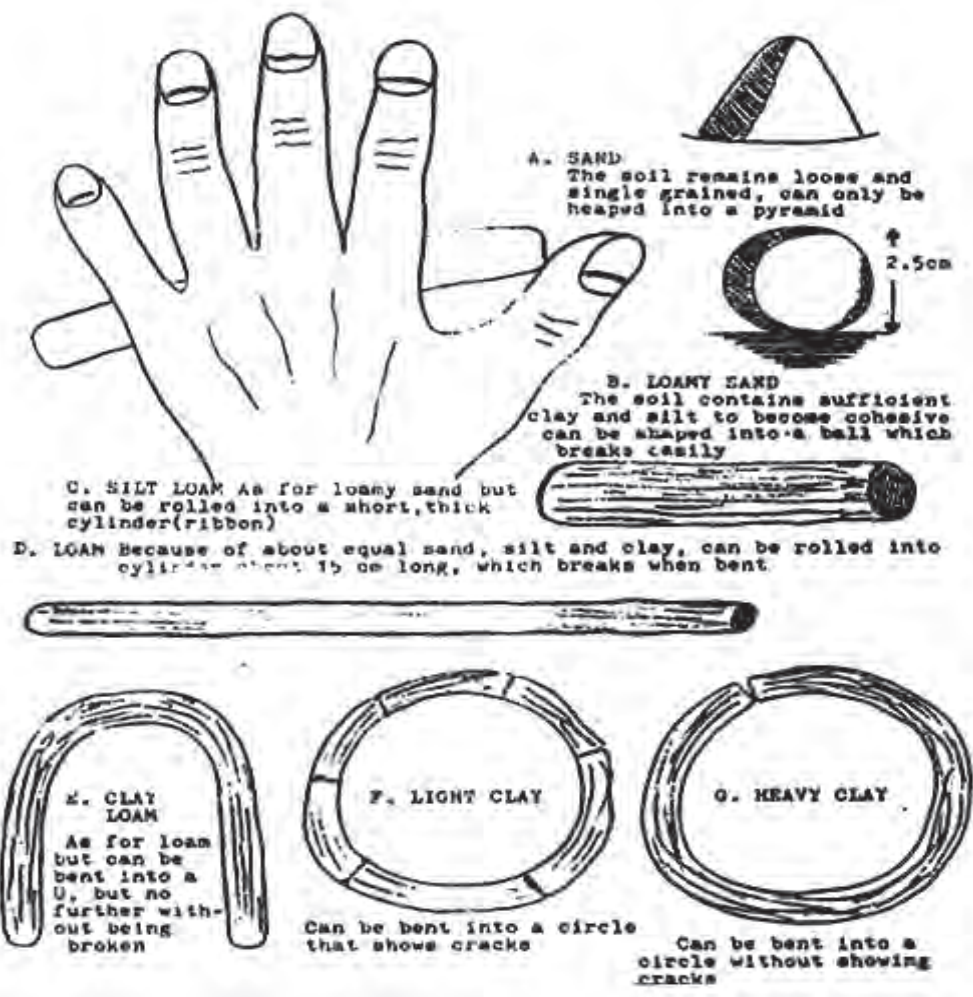

Figure 2. Practical field method of assessing soil texture (Source: Irrigation Agronomy Manual, former MoA/ADD, March 1990, Addis Ababa)

5.1.3 Soil structure

Soil structure describes the arrangement of individual particles of soil with respect to each other into a pattern or aggregates. Such aggregates may be held together by biological or chemical bonds such as clay, organic matter, microbial glue and mineral cementing materials like aluminum and iron oxides present in the soil. The chemical bonding, particularly in tropical zones are often held together by electrical forces, using positively charged oxides of iron and aluminum with that of the negatively charged silicate clay minerals. The basic types of soil aggregate arrangements are granular, blocky, prismatic and massive structures. Granular structure occurs normally only in sands and silts of low organic matter content and facilitates aeration and capillary movement of soil moisture. Massive structure is similar to single grained structure, except that it is coherent. The presence of the massive structure in the topsoil blocks the entrance of water and seed germination is difficult, due to poor aeration. On the other hand, if the topsoil is granular, the water enters easily and the seed germination is better. In a prismatic structure, movement of water in the soil is predominantly vertical and side flow is critically affected. Therefore, in prismatic structure the supply of water to the plant roots is usually poor, due to the uptake of water and soil nutrients are affected. Unlike texture, soil structure is not permanent. Through cultivation practices (ploughing, ridging, etc.), the farmer tries to obtain a granular topsoil structure for his fields to improve water entry and good seed germination.

A soil structure plays an important role in plant growth as it influences the amount and nature of porosity and regulates the proportion of water, air and heat regimes in the soil, besides affecting mechanical properties of soil. Massive structure slows the entry and movement of water into the soil and hinders free drainage. But crumb and granular structures provide the most favourable physical properties (infiltration, water-holding capacity, porosity and bulk density) of soil for plant growth. Therefore, from crop production point of view granular and crumb structures are more suitable and have better water holding capacity, which hold sufficient amount of available moisture to crop plants. The stability of soil aggregates against disintegrating forces of water and physical action is most vital in structural behaviours of soil. Soils high in water-stable aggregates are more permeable to water and air, while soil tends to puddle when stable aggregates are less. Puddling of soil as in wetlands destroys all soil structures and makes it difficult in preparing a good tilth for the crops to be planted. Therefore, capillary system formations, water-holding capacity, aeration, drainage, erosion and penetration of roots are affected by the soil structure.

Thus, the management of soils aims at obtaining soil structures favourable for plant growth, and yield, besides ensuring soil conservation, and good infiltration and movement of water in soils. Common methods of soil structure management include addition of organic matter and adoption of suitable tillage practices, soil conservation and cropping practices. Growing legumes, mulching, ensuring proper irrigation and drainage, occasional use of soil conditioners and application of balanced and optimum levels of fertilizers help in development of good physical conditions of soils. Tillage practices can be damaging to soil productivity when it is carried out at sub-optimal soil condition, since it can destroy physical condition of fine textured soils when the soil is too wet. In such cases, the naturally occurring soil aggregates, peds become fractured and thus, lose their water stability and consequently develop into hard clods. Such conditions produce an inferior seedbed as larger soil aggregates only loosely surround the seed reducing contact with soil moisture. Excessive tillage or wrongly timed tillage can also cause changes to the physical properties of soil, notably compaction, particularly fine textured soils are prone to compaction when tilled to wet or by excessive passage of animals, tractors and implements over the soils.

5.1.4 Soil bulk density

Bulk density (or *sometimes referred to as apparent specific gravity- As*) is one of the most important physical properties of soil, which defined as the ratio of the weight of a given volume of dry soil, including air spaces, to the weight of an equal volume of water, where 1 gram of water equals 1 cm³. This soil property is of great importance to the irrigation farmer as it determines the capacity of a soil to hold water. The bulk density of soils is influenced by its structure namely; the arrangement of soil particles, by its texture and degree of compaction. A given sample of soil, such as a cubic centimeter is not all solid; indeed on a volumetric basis, it may contain about 50% pore spaces occupied by water and soil. Thus, in determining bulk density it is necessary to remove all the moisture present in the soil by drying the soil sample in an oven to a constant weight at 105 °c. Typical ranges of bulk density are provided in Table 2 for different soils.

Table 2. Bulk density values of different soil types

Soil textural group	Bulk density, g/cm ³
Very heavy clay	1.0 - 1.1
Heavy clay	1.1 - 1.2
Medium	1.2 - 1.4
Light	1.4 - 1.5
Sand	1.5 - 1.6
Compact sandy clay	1.6 - 2.0

Bulk density or apparent specific gravity is calculated using the following formula:

$$Bd = \frac{W}{V} \quad \text{or} \quad As = \frac{Ws}{Vs} \quad (\text{Equation 1})$$

Where: Bd	=	Bulk density, g/cm ³
W	=	weight, gr
V	=	Volume, cm ³
As	=	Apparent specific gravity of a soil, (g/ cm ³)
Ws	=	Apparent specific weight of a soil, gr
Vs	=	Apparent specific volume of a soil, Cm ³

A practical but approximate method of determining bulk density of a soil can be achieved as follows:

- Put a tin can from which the top and bottom ends have been cut-off, into the soil;
- Remove carefully trimming of the soil with a knife and in this way a virtually non- disturbed sample of soil can be taken. The soil being in its natural state of compaction.
- Cover both ends of the can and its contents to prevent them from falling out and take to the oven;
- Place the can of soil in the oven and dry to constant weight at 105 °C, for two successive 24 hours until constant weights have been achieved.

The bulk density of the sample is calculated using the following formula:

$$V = \pi r^2 h$$

Where:	V	=	Volume of can
	π	=	3.1416
	r	=	radius of the can
	h	=	height. of the can

Example 1:

A sample of soil is taken, using a tin can with a radius of 5 cm and a height 11.5 cm from which the top and bottom ends have been cut off, and removed carefully trimming off the soil with a knife. The sample soil is placed in the oven to dry to constant weight of 1265.5 g. Calculate the bulk density of the sample soil?

Steps of calculation:

1. Calculate the volume of a tin can with 5.0 cm radius and a height of 11.5 cm;

$$\text{Volume of can} = \pi r^2 \times h = 3.1416 \times (5.0)^2 \times 11.5 \text{ cm} = 903.21 \text{ cm}^3$$

2. Constant weight of soil sample in a tin can is 1265.5 g;

3. Therefore, the soil bulk density is $\Rightarrow \text{Bd} = 1265.5 / 903.21 = 1.40 \text{ g/cm}^3$

The bulk density value calculated in the example illustrated above represents a value for light soil. Ideal bulk densities for good plant growth range from 1.2 for a clay loam to about 1.4 for medium sandy soil.

Real specific gravity /Rs/

The real specific gravity of a soil is defined as the ratio of the dry weight of a soil sample (W_s) to the net volume of soil occupied by the solid particles of the same sample (V_s). It is expressed as:

$$R_s = \frac{W_s}{V_s}$$

Where: R_s = Real specific gravity, gr/cm^3

W_s = dry weight of a soil sample, gr

V_s = net volume of soil occupied by the solid particles of the same sample, cm^3

The average real specific gravity of the common soil with low percent of organic matter is 2.65 g/cm^3 . Soils with high content of organic matter may have an average real specific gravity of 1.5 to 2.0 g/cm^3 .

5.1.6 Porosity

Porosity of a soil is defined as the ratio of the volume of voids (a space filled with air and water) to the total volume of soils and is expressed in percent of pore spaces between the particles of soil. Depending on the pore sizes existing in general, capillary pores and non- capillary pores or large pores, which induce drainage and aeration. As a general rule, coarse textured, stony and sandy soils have a lower proportion of total pore space than fine textured clays and clay loams.

The amount of pore space has a direct impact on the productive value of soils because of its influence on the water-holding capacity, the movement of air, water, root penetration and nutrients through the soil. Compaction of soil reduces the porosity of the soil by reducing the amount of pore spaces. In this regard, a 10 % reduction in porosity that might be caused as a result of an excessive tillage can have drastic consequences on the plant growth, due to greatly reduced porosity that can affect the movement of water and nutrients within the soil profile. A porosity of about 50 % is generally, considered ideal for most agricultural soils, however, its determination is difficult, since their size, number, shape and orientation vary greatly. A more practical method is to examine the development of existing plant roots in the soil prevailing. A well- developed plant root system would be a good indicative of a well-aerated soil of good porosity.

Porosity may be calculated using the available information on the bulk density and real density by the following relationship:

$$P = \left(1 - \frac{Bd}{Rd}\right) \times 100, \text{ or } \left(1 - \frac{As}{Rs}\right) \quad \text{(Equation 2)}$$

Where: P	=	Porosity, (%)
Bd	-	bulk density
Rd	-	real density and
As	-	apparent specific gravity
Rs	-	real specific density

Porosity is influenced by textural characteristics of soil and ranges from 35 to 50 % in sandy soils and from 40 – 60 % in clayey soil. It increases with an increase in fineness of particles, looseness of soils and amount of soil aggregates. Thus, a sandy soil has more non- capillary pores, which characterized by good drainage and aeration and low water-holding capacity, while the clayey soil has more capillary pores that characterized with high water-holding capacity, but it has poor drainage and aeration.

5.2 Soil Moisture

Soil moisture is one of the most important soil ingredients and dynamic properties of soil. Water affects intensely many physical and chemical reactions of the soil as well as plant growth. Only part of the soil moisture or water stored in the root zone of a crop can be available and utilized by the crop for its transpiration and building up of plant tissues. The remaining soil moisture is lost either through leaching beyond the active root zone of crop plants and/or lost into the atmosphere in the form of evapotranspiration.

5.2.1 Classification of soil water

Various forms of moisture occur in the soil. The small pores are required for moisture storage, medium- sized pores for water movement and large pores for aeration. The three main classes of soil water are:

- **Gravitational water:** This is the water that occupies the larger pore spaces and drains away from the root zone of a crop under the influence of gravity, unless prevented by impervious layer of soil, rock or a high water table. Its upper limit is when the pores are completely filled with water, when the soil is saturated. Depending on the soil type the rate at which the water drains downwards from the root zone will take less than a day in coarse sandy soils to more than 3 days in heavy clays.
- **Capillary water:** This is the water held by surface tension forces in pore spaces between soil particles. Its upper limit is when all the gravitational water has drained away and when the soil is said to be at field capacity. This is the main source of water to crop plants.
- **Hygroscopic water:** This is held as a very thin film round the particles of soil being held to firmly that in most circumstances it is unavailable to the plant.

Soils vary in their capacity to hold soil moisture according to their texture and physical structures. Fine soils such as clay soils can store much more water than coarser textured soils, such as sand soils. According to soil water availability to plants and drainage characteristics various forms of moisture occur in the soil:

- a) **Saturation:** Saturation capacity is reached when the pores of the soil are completely filled with water. It is then equal to the porosity of the soil.
- b) **Field capacity:** It is the upper limit of soil water defined as the amount of water present in the soil after gravitational water has been removed and the water content is relatively stable. Sandy soils drain readily, while clayey soils drain very slowly. In practice, the FC of sandy soils is usually determined by drying for at least 24 hrs in an oven at 105 °C after irrigation, whereas clayey soils may requiring 48 hrs or more. At this point, moisture is retained by the soil at 1/3 atmosphere.
- c) **Permanent wilting point:** It is at the lower end of the available moisture range. At this level of moisture content plants permanently wilt and they do not recover even if water is applied later to increase the moisture content of the soil. Both FC and PWP depends on the soil texture. At this point moisture is retained at about 15 atmospheres.
- d) **Readily available soil water:** The readily available soil water (AW) or the available soil moisture is the difference in the moisture content between FC and PWP, which is expressed as percentage of the dry weight of the soil or as percentage volume or as depth in mm of water. This is also known as capillary water because this water is retained in the soil pores by capillary action and is available for use to the plant. This is expressed as: $FC - PWP = AW$.

The amount of water that is available for plant growth is that portion of water between field capacity and permanent wilting point. The quantity of available soil water varies in different soils. The following table gives the various ranges of available soil moisture / Sa/ expressed in millimeter - mm of water per meter of soil for various soil types. It can be seen from the table that a heavy clay soil can hold at field capacity three times much water (180 mm of water per metre) as coarse textured soil (60 mm of water per metre of soil).

Table 3. Range of available soil moisture for various soil types

Water potential in bars	-0.2 /FC*	-0.5	-2.5	-15 (WP)*
Soil type	Available soil moisture, mm/m depth of soil- (Sa)			
Heavy clay	180	150	80	0
Silty clay	190	170	100	0
Loam	200	150	70	0
Silt loam	250	190	50	0
Silt-clay loam	160	120	70	0
Fine textured soils	200	180	70	0
Sandy clay loam	140	110	60	0
Sandy loam	130	80	30	0
Loam fine sand	140	110	50	0
Medium textured soil	140	100	50	0
Medium fine sand	60	30	20	0
Coarse textured soil	60	30	20	0

NB: * FC = Field capacity and WP = wilting point

Source: Irrigation Agronomy Manual, Revised Version, MoA /ADD, March 1990, Addis Ababa

5.3 Infiltration Characteristics of Soil

Infiltration is the process of entry of water and its downward movement from the surface into the soil. Water enters the soil through pores, cracks, wormholes, decayed-root holes, and cavities introduced by tillage. The infiltration characteristic of a soil is one of the dominant variables influencing irrigation. The rate at which water enters soil is called intake rate or infiltration rate. The infiltration rate of a soil is the maximum as soon as the water enters the soil when applied, at its surface. Infiltration rate is very rapid at the start of irrigation or rain but it decreases rapidly with the advance of time and eventually approaches a constant value. The constant value that reached after some times from the start of irrigation is termed as the basic infiltration rate. The actual rate at which water enters the soil at any given time is called *infiltration velocity*.

When water is applied at the surface, it enters the soil as fast as it is supplied as long as the supply rate is less than the intake rate of the soil. However, when the supply rate exceeds the intake rate, water ponds over the area or moves down the slope as runoff. Therefore, when irrigating, it is very important to control flow stream size as not to proceed over the intake rate of the soil.

5.3.1 Factors influencing infiltration rate

The infiltration rate is influenced by different factors. The major factors governing the rate of infiltration of water into the soil are *conditions and characteristics of the soil surface, tillage and crop management practices, vegetation cover, duration of irrigation and the level of water table*. Conditions and characteristics of the soil surface primarily involved in the process of irrigation are the initial soil water content, soil texture, soil structure, soil compaction, soil organic matter content, soil depth, depth of water table, soil surface sealing or forming crust, presence of cracks in soil surface and soil hydraulic conductivity.

Organic matter including encourages improving soil aggregates and increase macro-pores and porosity as a result it increases infiltration and improves soil moisture. A soil with higher proportion of sand allows water intake at a higher rate than that with more of silt and clay. A deep soil with good permeability allows greater infiltration than a shallow soil. As far as infiltration rate is concerned the soil surface with vegetation cover favors a greater infiltration than a bare soil, as vegetative cover encourages slow movement of water and this in turn gives more time for the water to infiltrate into the soil by minimizing surface run-off. Furthermore, infiltration rates become reduced over the

irrigation season, particularly when the irrigation water deposits fine soil particles in the irrigated fields. The soil water content and looseness of the soil surface exert a profound influence on the initial rate of the total amount of infiltration. When soil water content increases or soil gets compact, the rate and amount of infiltration decreases, soil tillage and crop management practices increase the looseness of soil and by that increase infiltration.

5.3.2 The removal of soil moisture by plants

Saturation capacity is the percentage of water content of a soil fully saturated with all its pores completely filled with water under restricted drainage. It is then equal to the porosity of the soil. Under normal conditions, gravitational water drains by gravity quickly from the root zone. After the drainage has stopped, the large soil pores are filled with both air and water, while the smaller pores are still full of water. At this stage, the soil is said to be at field capacity. At field capacity, the water and air contents of the soil are considered to be ideal for crop growth. The amount of water that is available for plant growth is that portion of water that is between field capacities, i.e. when all the gravitational water has drained away and that amount of soil moisture, which is held mainly as hygroscopic water, which the plant is unable to utilize quickly enough to maintain its normal growth. This lower limit is known as the *permanent wilting point*, because under such moisture conditions, plant leaves become permanently wilted. In this condition the plants permanently wilt and they do not recover, even if water is added later to increase the moisture content. This usually occurs at a suction pressure of 15 bars /atmosphere/ for the majority of crop plants. The water held between field capacity and permanent wilting point at a tension between - 0.2 - 15 atmospheres is referred as available water to crop plants, expressed as a percentage of the dry weight of the soil or as percentage volume or as depth in mm of water. The available water in moisture percentage by volume is given by the following formula:

$$AW = \frac{(FC - PW)AS}{D_w} \quad \text{(Equation 3)}$$

Where: Aw = Available water (% V)

FC = Field capacity, %

PW = Permanent wilting point (% by weight)

Dw = Water density = 1 g/cm³

As = Apparent specific gravity of a soil or bulk density, g/cm³

Temporary wilting point may occur in many crops on hot windy day, but the plants recover during the cooler portion of the day. The amount of available water depends on the texture and structure of soils and the amount of organic matter content present in the soil. Sandy soils drain readily, while clayey soils drain very slowly. In practice, the field capacity of sandy soils is usually determined 24 hours after irrigation, whereas clayey soils may require 48 hours or more. The field capacity can be measured by determining the moisture content of a soil after a heavy irrigation and drainage of the gravitational water. Samples from the soil profile are taken and then the moisture content determined by drying for at least 24 hours in an oven at 105 °C.

As a general rule, it is necessary to start irrigating when the soil moisture is about half way between field capacity and permanent wilting, the 50% rule. However, in the case of heavy clay soils, such as vertisols which have characteristics of swelling and cracking and generally have a low infiltration rate after they have swelled; the movement of water through them is largely facilitated by their shrinkage forming large deep cracks for the water to infiltrate. This occurs when most of the moisture has been depleted and if the 50% rule was followed, plants would suffer of moisture stress. Therefore, it is advised to start irrigating when the soil moisture depletion rate is at 60%.

5.3.4 Plant roots growth and rooting depth

The volume of water absorbed by a plant depends largely on the growth of root systems. Root development is most important for a better plant growth and ultimately increased yield. It dictates the amount of water that could be explored by plants from different layers of soils. Soil water of course, decides the depth of roots penetration and their lateral and relative growth and the same as for shoots. Roots grow more towards the moist soil and follow the water when they are in direct contact or close to it. With greater availability of water, roots grow increasingly with shoots. Roots provide the water absorbing surface and soils serve as the reservoir of water. Under, favorable conditions for root growth, the depth of rooting increases during the vegetative and flowering period, if there is no hard pan, rock or other impediment to root penetration of the soil. As a general rule, the hotter the climate or the longer the growing period, the deeper the roots will penetrate the soil. Thus, crops such as lettuce, phaseolus beans, which require three months to mature, do not penetrate the soil more than 30- 70 cm. In the contrary, longer maturing crops such as 6 months of maize, cotton and local cultivars of sorghum, which mature in some 8 months, penetrate the soil as much as 2m depth. Therefore, availability of water in the effective root zone is very crucial for root development.

The design water extraction depth of a crop is the soil depth from which the crop meets most of its water need. As a general rule, given a homogenous soil the greater part of root development takes place in the upper layer of the soil. With some 40% of the root growth occurring in the 1st quarter of the rooting zone, 30% from the 2nd quarter and 20% from 3rd and a more 10% from the last quarter. Thus, in order to obtain a fair estimate of the moisture status of the soil, it is necessary to make measurements of soil moisture at a minimum of two different soil depths.

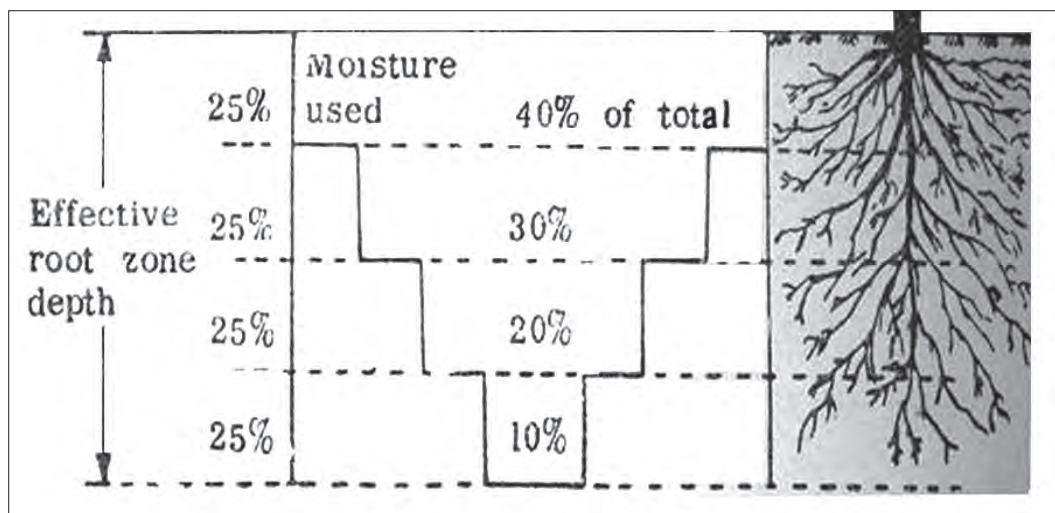

Figure 3. A soil water extraction pattern in soils of adequate soil moisture and without restrictive layer in the root zone

By contrast, in a soil, this is not homogenous but has layers of different permeability, the rooting and therefore, moisture extraction pattern will be different. This can be quite dramatic where there is a clay pan, or plough pan, which impedes both root development and the passage of water through the normal rooting zone of a crop. If there is a problem of plough pan, various remedial measures can be taken to alleviate such a problem, such as breaking up of the plough pan by deep cultivation using a single tined sub-soiler or by growing trees and other deep rooted crops whose roots are capable to penetrate such pans. If these remedial measures are not taken, then crops with very shallow root system can be grown with controlled water application to avoid waterlogging.

6. ESTIMATING CROP WATER REQUIREMENT

Module 5

Objectives:

After reading this chapter, readers and/or training participants will be able to:

- describe the influence of soil, climate, growing season, crop characteristics and cultural practices on crop water requirements;
- estimate reference crop evapotranspiration rate (ET_o) and actual crop water requirement;
- estimate effective rainfall and describe the major factors that influence effective rainfall.

6.1 Crop Water Requirement

Crop water requirements refer to the amount of water required to raise a successful crop with optimum yield in a given period or season. In another words crop water requirement is defined as “the depth of water needed to meet the water loss through evapotranspiration of a disease- free crop growing in large fields under no- restricted conditions including soil water and fertility and aimed at achieving full production potential of the crops under consideration. It comprises the water lost as evaporation from the crop field, water transpired and metabolically used by crop plants, water lost during application which is economically unavoidable, but can be reduced to some extent and the water used for special operations such as for land preparation and for leaching to bring the salinity level of the soil to salt tolerance level of the crop.

Water is one of the most critical inputs for obtaining maximum production of crops. Each crop has its own water requirement and maintains its own tolerance limits within which the moisture variations don't affect crop yields. Therefore, the moisture availability in the root zone of the crop could be maintained within the crop tolerance limits by adopting proper water management practices.

Crop water requirements are normally expressed by the rate of evapotranspiration (ET) in mm/day or mm/period and this may be formulated mathematically as:

$$CWR = E + T + IP + W_m + W_U + W_S = ET + W_m + W_U + W_S = CU + W_U + W_S \quad (\text{Equation 4})$$

Where: CWR = Crop Water Requirement

E = evaporation from crop field

T = transpiration by crop plants

IP = intercepted precipitation by crop plants that gets evaporated

W_m = water metabolically used by crop plants to make their body weight

W_u = economically unavoidable water losses during application
(seepage, evaporation & percolation)

W_s = water applied for special operations /pre- irrigation, leaching, etc

ET = evapotranspiration from crop field, E+T+IP

CU = consumptive use of water by the crop, ET + W_m

The water required by crops is essentially met from rainfall /precipitation/, irrigation, soil water and ground water sources. Considering the different source of water the water requirement of crops (CWR) may be expressed as,

$$CWR = P + I_r + \Delta SW + \Delta GW - (R + PW) \quad \text{Or} \quad CWR = P_e + I_r + \Delta SW + \Delta GW$$

Where: CWR = Crop Water Requirement

P = Precipitation

I_r = Irrigation requirement of crop

ΔSW = Soil water contribution for crop use. Difference between soil water contents at sowing and at harvest

ΔGW = Ground water contribution (usually from shallow water table)

R = Run-off

PW = Deep percolation

P_e = Effective rainfall

Effective rainfall is the portion of rainfall that goes to the soil water reserve for use of crops. This may be expressed as,

$$P_e = P - (R + PW) = \text{Rainfall} - (\text{run off} + \text{deep percolation})$$

In fact, not all precipitation received is being used by crop plants; there are losses through surface run-off and deep percolation beyond the active root zone, as part of an ineffective rainfall.

6.2 Evapotranspiration and Consumptive Use

Evaporation is a process of losing water to the atmosphere from an open water body and from the soil surface, while transpiration is a process of escaping water to the atmosphere as water vapour through the plant's leaves and stems. The term evapotranspiration (ET) refers to the amount of water lost through evaporation from the wet soil or water and plant surface in the crop field and the water transpired by crop plants including the portion of water used for building of plant tissues. Its value is largely determined by climatic factors; such as solar radiation, temperature, humidity, wind and the environment. Out of the total evapotranspiration, evaporation accounts for about 10 percent and plant transpiration for the remaining 90 percent. Therefore, crop water requirements encompass the total amount of water lost both through evaporation and transpiration including the water used by the crop for metabolic activities, which is termed as consumptive use of water by crop (Consumptive use, CU = ET + W_m). However, of the total consumptive use of water by crops the amount of water utilized for metabolic activities is hardly 1%, as a result evapotranspiration is often used synonymously with the consumptive use of water by crops. Evapotranspiration is usually expressed as surface depth of water in millimeters or centimeters. Evapotranspiration can be daily, peak, design, monthly, or seasonal.

Mathematically, it is represented as:

$$ET = E + T + IP \quad \text{(Equation 5)}$$

Actual crop evapotranspiration involves the use of a crop factor called; crop coefficient (K_c) while computing it from reference crop (ET_o) estimated by different empirical formulae or evaporation rates from evaporimeters. The ET_c varies under different soil water and atmospheric conditions and at different stages of crop growth, geographical locations and periods of the year.

The crop Evapotranspiration is formulated mathematically as:

$$ET_c = ET_o \times K_c$$

Where: ET_o = Crop Evapotranspiration

ET_o = Reference Crop Evapotranspiration

K_c = Crop coefficient

6.3 Factors Influencing Evapotranspiration

Evapotranspiration is influenced by various factors such as climate, growing season, crop characteristics, soil characteristics and cultural practices.

6.3.1 Climatic factors

Climate is one of the most important factors determining the crop water requirements needed for unrestricted optimum growth and increased crop yields. The principal climatic parameters such as precipitation, solar radiation, temperature, wind and humidity influence the crop water requirement (ET_c). Precipitation influences the ET_c to the extent that it reaches the soil surface and supplies water to the crop plants. Evaporation and transpiration occur at a potential rate when the supply of water is unlimited and ET_c becomes higher. Solar radiation supplies the energy for the ET processes. With increasing day length or solar radiation evapotranspiration also increased. The rate of ET in any locality is probably influenced more by temperature than any other factor. Temperatures of plant body and soil rise because of increased radiant energy received which leads to increased evaporation (E) and transpiration (T). Unusually low or high temperatures may retard plant growth activities and consequently the transpiration process. Rates of E and T are inversely related with atmospheric humidity, which means the consumptive use of crop plants increases with a fall in relative humidity in any given growing season. Similarly, evaporation from the soil surface and transpiration from plants occur at a higher rate on a windy day than under calm air conditions.

Table 4. Effect of major climatic factors on crop water needs

Climatic factors	Crop water need	
	High	Low
Sunshine	Sunny /no clouds	Cloudy /no sun
Temperature	Hot	Cool
Humidity	Low /dry	High /humid
Wind speed	Windy	Little wind

As it is clearly indicated in the table above, the highest crop water needs are thus, found in areas, which are hot, dry, windy and sunny conditions. The lowest values are found when it is cool, humid and cloudy with little or no wind. Evaporation losses are much larger in climates where the relative humidity is low. Here, it is clear to understand that a crop grown in different climatic zones will have different water need depending on the prevailing climatic conditions of each specific area. This means that a certain variety of maize crop grown in a cool climate will need less water per day than the same variety grown in a hotter climate. Even, in the same locality, a certain crop variety grown during the cooler months will need substantially less water than the same crop variety grown during the hotter months of the growing season. It is, therefore, useful to take a certain standard crop or reference crop, in this case a grass, and determine how much water the given crop needs per day in various climatic regions or zones.

6.3.2 Growing season

The total growing period is defined as the period from sowing or transplanting to the last day of harvesting of the crop. It is mainly dependent on crop type, variety, climate and the planting date. The growing period heavily depends on local circumstances so that data on the duration of the total growing period for various crops grown in the area can best be obtained locally. These data are very valuable for determining the crop water requirements within a specific locality. In general, it can be assumed that the growing period of crops or even a specific crop may have a longer period in cooler climates and shorter in warm climates. This is particularly associated with the effect of temperature, which usually determines the rate of crop development and consequently affects the length of the total growing period required for the crop to form optimum yield.

The length of a crop growing season and the actual date of sowing and maturity are important factors that influence the consumptive use of crop plants, particularly the growing period coinciding with the hotter part of the year. In this regard, crops sown in different seasons have different consumptive use owing variations in crop duration and other factors affecting the consumptive use of a crop. This is explained by the fact that varieties of a crop with short growing cycles will need less water while varieties of the same crop with long growing period need more water as compared with the short duration varieties. Of course, for different varieties of a crop having different growing periods grown in the same locality may have the same water need per day but varieties of a given crop with long duration will need much more water than the short duration varieties of the same crop. This is because the long duration varieties stay longer period in the field. Therefore, the crop-growing period has an important role in determining the ETc.

6.3.3 Crop characteristics

Crops have variable ET for variations in their growth habit, canopy development, leaf area index, plant density, spacing, duration and time of the year when the crop is planted and matured, drought tolerance nature of crops and as well as their rooting depths. However, plant species that are short, dense and uniformly vegetated, actively growing, infinite in extent and transpiring under unlimited soil water, have virtually an identical ET. A long period of growth favours greater consumptive use. Crops that have a faster rate of growth habit with quick development of foliage parts and roots have higher rates than those growing slowly. The influence of canopy development is also considerable. As the crop cover increases with canopy development, the evaporation from the adjacent soil surface gradually decreases, while the transpiration and resultant ET increase.

Crop density influences the ET in the same way as the crop cover influences the ET. The row spacing, seed rate and ultimate plant population decide the density of a crop. The plant population and other crop management practices that affect the net radiation at the soil surface, change the ET unless the soil surface and plants get constant water supply. With low plant population, the ET is low. Plant height increases ET by greater interception of advective heat.

The crop water needs differ depending on the growth stages of the crop. This in a simpler way can be explained by the fact that a fully-grown crop, for instance maize crop, will need more water than a maize crop, which has just planted. As a general rule, when the crop growth stages increase the water needs of a crop gradually increase and reached at the maximum during the flowering and grain filling stages for most crops, whereas towards the maturity period of the crop the water demand is gradually decreasing and ET is low. During early periods of plant growth, while much of the soil surface is exposed to sun and wind, the moisture loss by evaporation predominates. At later stages of crop maturity, much of the soil surface is shaded and protected from wind. Then transpiration water requirements predominate. Crops with longer duration and with large leaf area need more water than crops with short duration and with smaller leaf area, which need less water. Deep-rooted crops will have the capacity to extract water from deep soil layers and can withstand better of the soil moisture deficit as compared with shallow rooted crops.

6.3.4 Soil characteristics

Soil factors such as hydraulic conductivity and water-holding capacity affect ET of a crop to the extent that water supply is maintained to plants and the surface soil. Coarse textured and well-aggregated soils retain less water and have low hydraulic conductivity at relatively higher tensions and as a result, they support less ET compared to fine clays, unless frequent irrigations are provided. Crop residues on the soil surface and light colour and rough surface of the soil decrease the ET by reflecting greater amount of radiant energy. The soil moisture content also influences ET as in the case of moist soil ET increases while in dry soil condition ET decreases.

6.3.5 Cultural practices

Irrigation practice is the most important contributing factor to the amount of ET. A wet soil contributes more to the ET than dry soil, since water loss by evaporation increases in the case of wet soil. Frequency, method and depth of irrigation influence the ET to the degree of wetness of the soil surface and water availability attained. Frequent irrigation encourages water loss by evaporation because wet soil increases the rate of evaporation as the surface soil remains wet for relatively longer periods and the soil water is maintained at relatively low suction. Irrigation methods such as surface methods and sprinkler to some extent resulting in wetting larger areas are leading to higher ET as compared with drip systems, which are considered as the most efficient method for economic use of the available irrigation water, so far developed.

Tillage practices play their parts in controlling the ET largely through their effects on water storage in the root zone. Very shallow stirring or cultivation of the surface soil to a few centimetres depth is essential for most short season crops, in order to minimize the effect of evaporation by cutting down the supply of water from deep soil layers to the soil surface by breaking the capillary tubes through which water loss to the atmosphere may occur. However, deep stirring of the surface soil more than 8 to 10 cm may increase the water loss, if the crop cover is sparse. Weed control is also necessary to reduce the water loss through transpiration by weeds. Fertilizer application increases

the ET and the consumptive use by producing greater biomass and developing a deeper and extensive rooting system. This is mainly, due to increased transpiration by the greater biomass produced and exploration of greater amount of soil water by the root system. However, the consumptive use is not significantly influenced by fertilizer application. Mulching reduces the ET by reducing the evaporation from the bare soil, particularly in areas with limited water supply and at early crop stages when the crop cover is relatively less, reflecting the solar radiation and reducing the weed population that can affect the overall crop water requirement.

6.4 Estimating Reference Crop Evapotranspiration (ET_o)

The influence of climate on crop water need is given by the Reference Crop Evapotranspiration (ET_o). The ET_o is usually expressed in millimeter per unit of time (mm/day, mm/month, or mm/season) and is defined as the rate of evaporation from a large area, covered by green grass, 8 to 15 cm tall, which grows actively, completely shades the ground and which is not short of water. ET_o can be determined using various methods. These can include: (i) direct methods, (ii) pan evaporimeter method and (iii) empirical methods.

6.4.1 Direct methods

Direct methods are the water balance or hydrologic methods and include: (1) Lysimeter, (2) Field experimentation, (3) Soil water depletion or soil moisture studies on plots and (4) Inflow- outflow methods /the water balance method/. These methods give more reliable results, but require adequate equipment and precise measurements. They are, however, costly, laborious and time consuming, due to that they are not widely applied. However, it is presented here to give some highlights of the theoretical background of the methods, even though the methods are not found wide application, particularly in the Ethiopian context, unless and otherwise they are applied for research purpose. Hereunder, are discussed only the Pan Evaporation method and the modified Penman method.

6.4.2 Pan evaporation method

There exists a close relationship between the rate of consumptive use by crop and the rate of evaporation from properly located pan evaporimeter. Evaporation pan provides a measurement of the combined effect of all atmospheric factors such as temperature, humidity, wind speed and sunshine on evaporation from a specific open water surface. It is, therefore, gives more accurate estimate of short-term change in evapotranspiration computed from it than computed with the empirical formulae that depends on fewer climatic factors. For determination of ET_o data required are mean pan evaporation (E pan in mm/day), estimated values of mean relative humidity in % and mean wind run (U in km/day at 2 m height) and information on whether the pan is surrounded by a cropped area or by dry fallow area. Actually there are different types of evaporation pans being used. However, the best- known evaporation pans are the class- A pan evaporimeter, a standard pan made by US Weather Bureau (circular pan) and the Sunken Colorado pan (square). The class- A pan is, however, most widely used method for determination of ET_o.

The working principles of the class- A pan evaporimeter are summarized as follows: (1) The pan is installed in the field, mounted on a wooden frame elevated 15 cm above ground level so that air may circulate beneath the pan; (2) The pan is filled with a known quantity of water /the surface

area of the pan is known and the water depth is measured/, usually 5 cm below the rim; (3) The water is allowed to evaporate during a certain period of time /usually 24 hours/; (4) After 24 hours, the remaining quantity (i.e. water depth) is measured (measurement is usually taken at 7:00 hours in the morning). In addition, rainfall, if any, is measured simultaneously; (5) The amount of evaporation per unit time /the difference between the two measured water depths/ is calculated and this is the pan evaporation rate: E_{pan} (in mm/24 hrs) and (6) Therefore, as the rate of evaporation from pan evaporimeter is higher than that over a large free water surface, the pan evaporation value is multiplied by a pan coefficient, k_{pan} , to obtain the ET_0 over the large free water surface (E_0). The pan has actually 120.7 cm diameter and 25 cm depth.

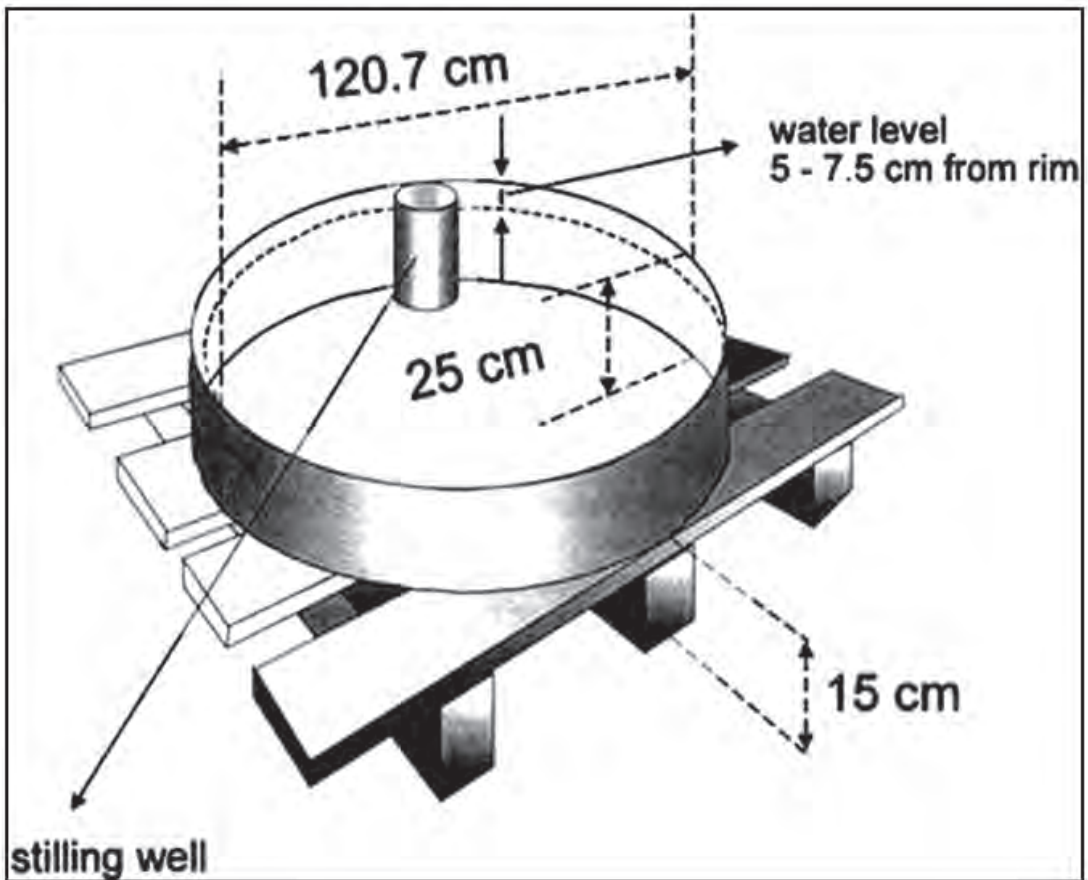

Figure 4. Class A evaporation pan

For class- A evaporation pan, the k_{pan} varies between 0.35 and 0.85, then on average a commonly used value of k_{pan} is 0.7. For the Sunken Colorado pan, the k_{pan} varies between 0.45 and 1.1 and the average value of k_{pan} is 0.8. The supplier of the pan usually provides details of the pan coefficient. If the pan factor is not known the average value could be used (For further details of k_{pan} , please refer Annex VI Table 47). The pan coefficient, k_{pan} , depends on: The type of the pan used, the pan environment; if the pan is placed in a fallow or cropped area, the climate- humidity and wind speed.

	The k pan is high if:		the k pan is low if:
✓	the pan is placed in a fallow area;	-	the pan is placed in a cropped area;
✓	the humidity is high or humid;	-	the humidity is low or relatively dry
✓	the wind speed is low	-	the wind speed is high.

As the rate of evaporation from pan evaporimeter is higher than that over a large water surface, the pan evaporation value for class- A pan is multiplied by 0.7 to obtain the evaporation rate over the large free- water surface (E_o). The relationship between actual evaporation and pan evaporation rates may be expressed as:

$$ET_o = K_{pan} \times E_{pan} \quad \text{(Equation 6)}$$

Crop evapotranspiration rates (ET_c) for various crops may be estimated from pan evaporation rates multiplied by a factor, called crop factor (K_c). The value of the crop factor for any crop varies with stages of crop growth, extent of ground cover with foliage, foliage characteristics, climate and geographical locations. Consumptive use by crops is usually low at the early stages of crop growth. It increases with the crop vegetative stages and reaching the maximum at flowering and then declines towards the crop maturity. The relationship between pan evaporation rate (E_{pan}) and crop evapotranspiration rate ET_c may be given by:

$$ET_c = K_c \times ET_o \quad \text{(Equation 7)}$$

Where: ET_o	=	reference crop evapotranspiration in mm/day
K_{pan}	=	pan coefficient
E_{pan}	=	Pan evaporation in mm/day (class A pan).
ET_c	=	Crop evapotranspiration
K_c	=	crop coefficient

Example 2:

Given: type of pan – class- A pan, water depth in the pan on day 1 = 150 mm, water depth in the pan on day 2 = 144 mm, no precipitation during 24 hours and $k_{pan} = 0.75$. Then calculate ET_o :

Calculation: $ET_o = k_{pan} \times E_{pan}$; $E_{pan} = 150 - 144 = 6$ mm/day $\Rightarrow ET_o = 0.75 \times 6 = 4.5$ mm/day;

6.4.3 Estimating evapotranspiration by empirical formulae

In view of the difficulties in direct measurement of water requirement of crops, methodologies have been developed to predict the amounts of water needed to obtain optimal crop yields based on climatological data, crop coefficients and to some extent on other factors. Different researchers

of the world have been developed various empirical formulae, of which the Blaney- Criddle, Thornwaite, Penman and Radiation methods are commonly used. However, among these, the modified Penman method is the one widely used in estimating ET_0 . In general, the modified Penman and Radiation methods are considered as the more accurate methods to obtain more appropriate results even for periods of 30-day period or as short as 10 days, but not accurate as that of the experimental method. The empirical formulae make use of only one to several climatic parameters for estimating the PET or ET_0 , which is expressed in mm per day and represents the mean value over that period and that way they do not give very accurate estimates.

Table 5. Climatic data required for determination of ETO using different empirical formulae

Method	Temperature	Humidity	Wind	Sunshine	Radiation	Evaporation	Environment
Blaney- Criddle	*	0	0	0	-	-	0
Radiation	*	0	0	*	(*)	-	0
Penman	*	*	*	*	(*)	-	0
Pan evaporation	-	0	0	-	-	*	*

NB: * - measured data, 0- estimated data, (*) - measured data if available but not essential

Source: FAO, J. Doorenbos and W.O Pruitt, Crop Water Requirement, Irrigation and Drainage Paper (Revised) No. 24, 1977

Primarily, the choice of the method in determining the ET_0 using any of the aforementioned empirical formulae must be based on the type of climatic data available and on the accuracy required in determining the water needs of crops. Before calculating ET_c , a review should be made of specific studies to determine crop water requirements in the area and available measured climatic data. In this regard, meteorological and research stations should be visited and environment, types of instruments and observation and recording practices should be appraised to evaluate accuracy of available data. Data related to crop type and development stages, and cultural practices, should be collected.

Overall, the calculation procedures of crop water requirements should follow the following steps:

- 1. Reference crop evapotranspiration (ET_0):** Collect and evaluate available climatic and crop data; based on meteorological data available and accuracy required, select prediction method to calculate ET_0 . Compute ET_0 for each 30-or 10-day using mean climatic data;
- 2. Crop coefficient (kc):** Select cropping pattern and determine time of planting, rate of crop development, length of crop development stages and growing period. Then select kc for a given crop and stages of crop development under prevailing climatic conditions;
- 3. Crop evapotranspiration (ET_c):** Calculate ET_c for each 30- or 10- day period:
- 4. Factors affecting ET_c** under prevailing local conditions: Determine effect of climate and its variability over time and area. Evaluate the effect of soil water availability together with cultural practices. Consider relationship between ET_c and level of production.

Calculation of ET_0 using the modified penman method

The modified Penman method is recommended to be adapted for areas where measured data on temperature, humidity, wind and sunshine duration or radiation are available. The Penman method is consisted of two terms: the energy /radiation/ term that include the temperature and sunshine

duration, whereas the aerodynamic term includes wind and humidity. The relative importance of each term varies with climatic conditions. In this regard, in more arid regions the radiation term becomes relatively more important than the aerodynamic term, but in humid and sub-humid areas the aerodynamic term becomes more important than the radiation term.

The reference crop evapotranspiration (ET_0) is usually calculated by using Crop Wat software program that uses the FAO (1992) modified Penman- method. The method is given as:

$$ET_0 = c[W.R_n + (1 - W.f(u).(ea - ed)] \quad \text{(Equation 8)}$$

Where ET_0 = the reference crop evapotranspiration, mm/day- adjusted

W = temperature and altitude related weighting factor for the effect of radiation on ET_0

R_n = net radiation in equivalent evaporation (mm/day) = $R_{ns} - R_{nl}$

R_{ns} = net incoming short wave solar radiation = $R_A(1-r)(0.25+0.50 n/N)$ in which R_A is extra -terrestrial radiation expressed in mm/day, n/N is the ratio between n = actual sunshine duration of bright sunshine hours and N = maximum possible duration of bright sunshine hours and r is the reflection coefficient

R_{nl} = net long wave radiation = $f(t) . f(e_d) . f(n/N)$

ea = saturation vapor pressure in mbar at the mean air temperature in $^{\circ}C$

ed = mean actual vapour pressure of the air in mbar, $ed = ea \times RH/100$, in which, RH = mean relative humidity expressed in percentage

$f(u)$ wind function, $f(U) = 0.27 (1 + U/100)$, U is wind speed in km/day measured at 2 m height; = /Table 39/ and mean actual vapour pressure of air (ed) in mbar

$(I-W)$ = a temperature and elevation related weighting factor for the effect of wind and humidity on ET_0

$(ea - ed)$ = distance between saturation vapour pressure at mean air temperature

c = adjustment factor to compensate for the day and night effects of wind for RH_{max} and R_s

The procedures to calculate ET_0 may seem rather complicated. This is, due to the fact that the formula involved different measured climatic data or derived from measured related climatic data when there is no measured data available locally. For instance, for places where there is no measured climatic data on sunshine duration, solar radiation or cloudiness observations, humidity and temperature, then these can be obtained from related measured data source, provided very often in literatures, where computation techniques and Table values are given to facilitate the calculations (FAO, Irrigation and Drainage Paper No. 33, J. Doorenbos and A.H. Kassam, 1986). Despite, its accuracy the Penman modified method has drawbacks as the method requires

various climatological parameters that may not be available in all meteorological stations and the computation procedure is cumbersome. Furthermore, it is important, here, to highlight that, due to the interdependence of the variables composing the equation, the correct use of units of measurement, in which variables need to be expressed, is essential.

Example 3:

Compute the reference crop ET_0 in mm/day for a given area located at 10^0 N and at an elevation of 1,000 m, using the modified Penman formula from the data provided below. Given data for the month of April: (1) Monthly average daily maximum temperature, (T max) = 34.4 °C; (2) Monthly average daily minimum temperature, (Tmin) = 25.6 °C; (3) Monthly average daily wind speed measured at 2 m, (U_2) = 2 m/s ; (4) Monthly average daily actual duration of sunshine hours (n) = 8.5 h/day; (5) Mean monthly average temperature, (Tmonth, i) = (34.4 + 25.6) /2 = 30 °C; (6) RH mean for the month of April is 50 % and RH max for the same month is 75 %.

Based on the information or data provided above the calculation procedures is presented in Table 6 below.

Table 6. Standard calculation sheet of ET_0 using the Penman modified method

Parameters	Calculation procedures	Results	Unit
T max	Given	34.4	°C
T min	"	25.6	°C
T mean	$T \text{ mean} = (T \text{ max} + T \text{ min}) /2 = (34.8 + 25.6) /2$	30.0	°C
Altitude		1,000	M
	$0.27(1 + U/100)$; $U_2 = 17.28$ km/day, $U_2 =$ wind speed at 2 m height	0.32	
e_a	For T mean = 30 °C , Table 39	42.4	mbar
e_d	$= e_a \times RH/100$	21.2	mbar
Vapour pressure deficit ($e_a - e_d$)		21.2	mbar
T max		34.4	°C
Calculation for extraterrestrial radiation and daylight hours (N) for the month of April			
	Latitude = 10^0 N	10^0	N
	$R_a =$ Table 40	15.7	mm/day
	$N =$ day length = Table 41	12.3	hours
	$n/N = 8.5/12.3$	0.69	-
R_s	$R_s = (0.25 + 0.50n/N) R_a = [0.25 + 0.50 (0.69)] (15.7)$	9.34	mm/day
R_{nl}	$= f(T).f(ed). f(n/N) = (d T \text{ max}, k^4 + d T \text{ min}, k^4) /2$		
	Tables 42, 43 & 44 = $16.7 \times 0.135 \times 0.73 =$	1.65	mm/day
R_n	$R_n = 0.75R_s - R_{nl} = 0.75 (9.34) - 1.65 =$	5.36	mm/day
T April		30.0	°C
W	$T_{\text{mean}} = 30$ °C, 1,000 m; Table 45	0.8	
C	RH max 75 %, $R_s = 9.34$; $U_{\text{day}}/U_{\text{night}} = 1.5$; Table 46	1.06	
ET_0	$C\{w.R_n + (1-W).f(u).F(e_a - e_d)$ $= 1.06 \{0.8 \times 5.36 + (1 - 0.8)\} \times 0.32 \times 21.2$	5.65	mm/day

6.4.4 Selection of crop coefficient

As discussed earlier, the reference crop evapotranspiration (ET_0) has been determined using different prediction methods. The reference crop evapotranspiration (ET_0), then further related to the effect of crop characteristics, crop coefficients- k_c in order to determine the crop water requirements (ET_{crop}). The crop coefficient value (k_c) relates to evapotranspiration of a disease-free crop grown in large fields under optimum soil water and fertility conditions and achieving full production potential under the given growing environment. The crop coefficient (K_c) is crop specific and used to modify potential evapotranspiration of a particular crop in relation to ET_0 . The value of K_c largely depends on the level of ground cover and the frequency with which the soil is wetted by rain and/or irrigation. For most crops, K_c increases from a low value (0.5–0.9) during the initial stages of growth, to a maximum value (0.9–1.2) during the period when the crop reaches full development, and declines again (0.3–0.9) as the crop matures. The factors that affect the crop coefficient values are: (1) Sowing dates; (2) Stages of crop development and length of each growth stage; (3) Length of total growing season; (4) Crop characteristics and (5) Climatic conditions.

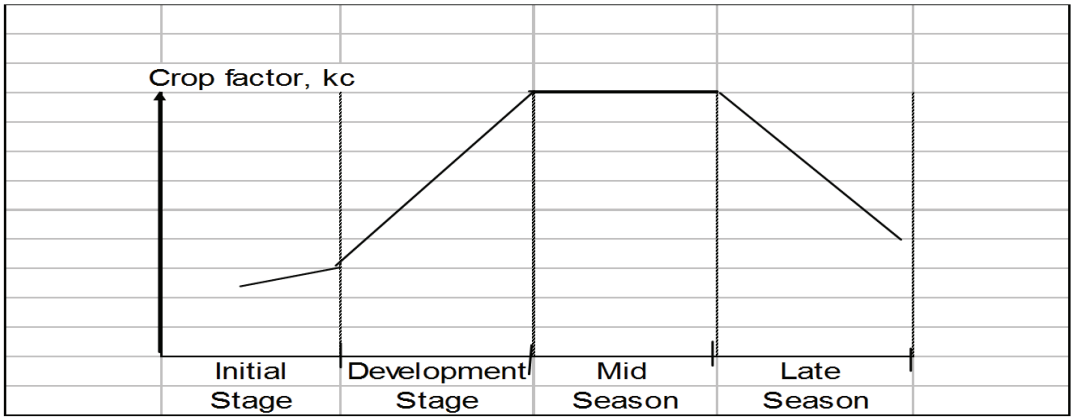

Figure 5. Generalized crop coefficient curve for the single crop coefficient approach

The effect of crop characteristics on the relationship between ET_{crop} and ET_0 is summarized as variations of crops, due to the resistance to transpiration and differences in crop height, roughness, reflection and ground cover. The crop planting or sowing date will affect the length of the growing season, the rate of crop development to full ground cover and onset of maturity. Crop development will also affect the overall ET_{crop} , since there are time variations of crops to reach full development or maximum water demand. Therefore, in selecting the appropriate k_c value for each period or month in the growing season for a given crop, the rate of crop development must be considered. In addition, climatic conditions, especially wind and humidity should also be considered. Wind will affect the rate of transpiration of taller crops more, due to air turbulence above the rougher crop surface. This is more pronounced in dry climates than in humid climates and K_c values for rougher crop surfaces are, therefore, greater in dry climates. Once the total growing period is known, then the duration of the various stages of growth of a crop can be determined. The crop growing period, in general is divided into four stages: *initial stage*, *crop development stage*, *mid- season stage* and *late season stage*. Descriptions of the four crop development stages are indicated in Table 7.

Table 7. Description the four crop growth stages

Crop development stages	Distinguishable characteristics
Initial stage	This is a period from sowing or transplanting through germination and plant emergence until about 10 % ground cover is achieved. Water loss is practically all evaporation at this time
Crop development	This period starts from the end of initial stage to attainment of effective full ground cover (ground cover \cong 70 - 80 %
Mid- season stage	This period starts at the end of crop development stage to the time of start of maturing /ripening/ of a crop as indicated by discolouring of leaves or leaves falling off. The crop is physiologically capable of the highest water use during this time. The crop coefficient is therefore, highest at this particular growth stage of crops.
Late- season stage	This period starts at the end of mid- season stage until full maturity or harvesting of a crop.

The steps that should be followed to determine kc values or crop factor for different crops are:

- *Establish planting date from local information:* This may vary significantly from dry land to irrigated conditions, well fertilized to non-fertilized crops, and even for plantings at different times;
- *Establish the length of the crop development stages:* Collect information on the length of each crop development stage from local information sources; local research centers and extension service, interviews with farmers and agricultural technicians, or crop data from similar climatic zones can be used to establish the crop development stages. Very often research or extension personnel or farmers do not typically record these data, therefore, it is often necessary to correlate these dates with more identifiable crop growth characteristics. For example, for grain crops, 10% ground cover is usually reached from 10 to 15 days after emergence. Effective cover for annual crops occurs approximately at the time of flowering. Discoloring or dropping of leaves indicates the start of maturity for many crops. At the end the total growing period of a given crop should be determined.
- *Determine the K_c values for the corresponding growth stages:* K_c values are taken from Tables (refer to Annex III Table 37 of this training manual).

Therefore, determine the irrigation requirements for each crop development stage for 30- or 10- days' period, considering the predetermined ET_0 and K_c values of the corresponding crop development stages. The value kc varies with development stages of the crop and to some extent with wind and humidity. For most crops, the kc value increases from a low value at the time of emergence to a maximum value during the period when the crop reaches full development, and decline as the crop matures. For most crops the K_c value for the total growing period is between 0.85 and 0.9 with the exception of crops like banana, rice, coffee and cocoa, which have higher values and a lower value for citrus, grape, sisal and pineapple. However, the need to collect local

data on the growing period and rates of each crop development stage of irrigated crops is highly important (if local data are not available, use crop coefficients provided in annex III).

Example 4:

Determine the crop water need of tomato, taking into consideration the following data:

- Month Jan Feb Mar Apr May Jun Jul Aug Sept Oct Nov Dec;
- ET_O (mm/day) 4.0 5.0 5.8 6.3 6.8 7.1 6.5;
- Humidity: Medium (60 %);
- Wind speed: Medium (3 m/sec);
- **Duration of growing period (from sowing) = 150 days and planting date: 1 Feb (direct sowing).**

Calculation procedures:

1. Estimate the duration of the various growth stages, using approximate values of crop growth stages as indicated in Annex IV, Table 38;
2. Indicate on a Table the ET_O values and the duration of the growth stages;

Crop	Total growing period	Initial st.	Crop dev't	Mid S.	Late S.
Tomato	150	35	40	50	25

3. Estimate the K_C factor for each of the four growth stages, using Annex II, Table 37 and bearing in mind that the humidity and wind speed are medium and the k_c values for the corresponding growth stages are 0.45, 0.75, 1.15 and 0.80;

4. Calculate on a monthly basis, the crop water need, using the formula: $ET_C = ET_O \times K_C$ (mm/day);

5. Calculate the monthly and seasonal crop water need (assuming all months have 30 days).

Following the calculation procedures described above sample calculations are illustrated how to determine the water requirement of tomato taking into account the available data provided above are shown in Table 8.

Crop- Tomato Planting date: 1 Feb Harvesting- 30 June

Table 8. Calculation sheet of crop water need

Parameters	Months											
	J	F	M	A	M	J	J	A	S	O	N	D
ET_O (mm/day)	4.0	5.0	5.8	6.3	6.8	7.1	6.5					
Growth stages		In.st	dev't stage		Mid season stage		Late stage					
K_C per gr.st.		0.45	0.75		1.15		0.8					
K_C per month		0.45	0.70	0.95	1.15	0.85						
ET_C (mm/day)		2.3	4.1	6.0	7.8	6.0						
ET_C (mm/month)		69	123	180	234	180						
ET_C for growing season	= 786 mm (786 mm x 10 m ³ = 7 860 m ³ /ha)											

Example 5:

Maize, planted 1 May, harvested 31 Aug.; initial stage - 20 days, development stage - 35 days, mid season stage- 40 days and late season stage- 28 days; wind speed is lighter to moderate and Rh is low.

Calculation:

Crop - maize, K_c values are 0.4; 0.75; 1.15 and 0.85 for each crop development stage respectively. So based on the ET_o value obtained earlier using the modified Penman method, which is equal to 5.65 mm/day, then the ET_c can be calculated for each crop development stage using the appropriate K_c values for the respective growth stage using the formula, $ET_c = ET_o \times k_c$. Therefore, the calculated ET_c values for each crop development stage of maize are 2.26, 4.24, 6.50 and 4.80 mm/day.

Once the actual crop evapotranspiration or crop consumptive use of water is found, then the next step is to determine the depth of water to be applied. Of course, this depends on the soil type and crop, since different soil types have different water-holding capacity and the availability of water varies depending on the water-holding capacity of the soil. Considering the water holding capacity of the soil and the crop root depth the total water requirement for a particular crop can be determined. For example; if we consider maize crop with rooting depth of 1 m, which is grown in medium textured soil with moisture available capacity of $S_a = 140$ mm/m, the total water required is: $WR = D \times S_a = 1.0 \text{ m} \times 140 \text{ mm/m} = 140 \text{ mm}$, if the allowable depletion for maize is 55 %, then the water required can be determined as: $1.0 \text{ m} \times 140 \text{ mm/m} \times 0.55 = \underline{77}$ mm.

6.5 Effective Rainfall

There are different concepts on the definition of effective rainfall or precipitation. However, very often effective rainfall is defined as portion of rainfall that is not lost from the farm, either as surface runoff or as deep percolation to subsurface drainage and contributes to the evapotranspiration requirements of a crop to obtain optimum crop production.

This can be expressed as: $\text{Precipitation} = ET + \text{Runoff} + \text{deep percolation} + \text{Change in total water content}$. Therefore, mathematically the effective rainfall is expressed as the difference between the total rainfall and that portions of rainfall, which are lost through surface runoff, evaporation and deep percolation ($Pe = P - R - ET - DP$) and only the water retained in the root zone can be used by the crop plants.

The effective rainfall comprises: the portions of precipitation, which are intercepted by vegetation, portion of rain used to replenish the soil water deficit and the portion of rainfall used for cultural operations and leaching salts and part of the rainfall that percolates beyond the root zone or is lost through surface run-off is termed as ineffective rainfall unavailable for plant growth. Of course, the texture and structure of the soil have significant influence on the proportion of the rainfall, which is considered as effective for plant growth. In the high rainfall areas with heavy textured soils the loss through surface run-off will have a significant influence, whereas in light textured soils losses will be greater through deep percolation. In addition, among the factors that have influences on the amount of rainfall received in general, are climate and depth of the root zone. Methods for determining of the effective precipitation involve measurement of precipitation losses through surface run-off and deep percolation beyond the root zone and soil-water used by crops. As a general guide, the following formula can be used to calculate the effective rainfall.

$$P_e = (P \times 0.7) - 10$$

(Equation 9)

Where: P_e = effective rainfall, mm

P = actual rainfall received expressed in mm

Thus, if the recorded rainfall amount is 70 mm, then the P_e is $(70 \times 0.7) - 10 = 39$ mm. Sometimes, it can be roughly estimated as $P_e = 0.8 P$, where $P > 75$ mm/month or $P_e = 0.6 P$, where $P < 75$ mm/month. The amount of rainwater retained in the root zone as effective rainfall should be then deducted from the total irrigation water requirements calculated.

E.g; the daily crop water requirement of maize during the initial growth is 2.26 mm/day and for the monthly requirement will be then 67.80 mm/month ($2.26 \times 30 = 67.80$ mm/day). During this initial crop growth period a rainfall amounting 70 mm was recorded and the effective rainfall calculated is equivalent to 39 mm. Thus, the net irrigation requirement within that period is 28.80 mm/month ($67.80 - 39.00 = 28.80$ mm/month).

6.5.1 Factors influencing effective rainfall

Many factors influence the amount of effective rainfall of which climate and soil textures are not influenced by the farmers, whereas soil structure can be influenced. Factors that influence effective rainfall are:

- **Climate /rainfall characteristics:** Climate determines the amount, intensity and distribution of rainfall which have direct influence on the effective rainfall. Greater quantities as well as intensities of rainfall normally reduce the effective fraction, increasing runoff and reducing infiltration. Similarly, even distribution enhances the extent of effective rainfall, while uneven distribution decreases it. Well-distributed rainfall with light showers is more conducive to crop growth than heavy rainfall.
- **Land:** Topography, slope, type of use influence effective rainfall. The slope of the land has a profound influence on the time available for the rainwater to infiltrate into the soil. On flat and leveled land there is more opportunity time for infiltration than in sloping and undulating lands where there is rapid runoff and as a result effective rainfall is reduced.
- **Characteristics of the soil:** The fraction of effective rainfall increased with increased water-holding capacity of the soil. The amount of water held and retained by a soil depends upon its depth, texture, structure and organic matter content. The moisture content of the soil at the time of occurrence of the rain affects the effective rainfall considerably. The higher the moisture content, the lower infiltration rate and higher surface runoff, which reduces the P_e . In coarse textured soils, infiltration increases and large part of the rainfall percolates below the root zone, as a result the effective rainfall is reduced, while in fine textured soil the infiltration is slow and much of the water is stored in the root zone.
- **Groundwater characteristics:** The amount of effective rainfall is greater when the water table is deep than when it is shallow. Water moves upwards in the soil by capillary, thus reducing the deficit of moisture and hence, of effective rainfall.
- **Management practices:** Management practices that influence runoff, infiltration, hydraulic conductivity or evapotranspiration also influence the degree of effective rainfall. Bunding, terracing, contour tillage, ridging and mulching reduce runoff and increase effective rainfall.
- **Crop characteristics:** Crops with high consumption use rate of water create greater deficits of

moisture in the soil. The P_e is directly proportional to the rate of water uptake by the plant. Crop characteristics influencing the rate of water uptake are the degree of ground cover, rooting depth and stage of crop growth. Deep-rooted crops have the ability to extract water from deep layers of soil, therefore, increase the proportion of P_e in a given area.

6.6 Irrigation Requirement

Irrigation requirement of a crop refers to the amount of water needed to be applied as irrigation to supplement the water received through rainfall and soil profile contribution in meeting the water needed of the crop for optimum growth and yield. It may be classified into net and gross irrigation requirements.

6.6.1 Gross irrigation requirement

Not all water available at the head of a canal is available to fulfill the net irrigation requirements. Part of the water is lost during transport through the canals and in the field. The remaining part is stored in the root zone and eventually used by the plants. In other words, only part of the water is used efficiently, the rest of the water is lost for the crops on the fields that were to be irrigated.

Gross irrigation requirement denotes the amount of the water pumped or diverted through the scheme inlet including all the losses during transportation and application. It includes the losses that may occur in conveyance systems and in the farm application systems (including losses to deep percolation, evaporation, and surface runoff, as well as leaching requirements). This can be determined at the outlet head or canal head regulator for calculating, the design discharge capacity of the main off-taking canal. The losses generally, depend on lined or unlined networks, the surface area and the ground percolation. The gross irrigation water requirement (I_{rg}) can be determined if the conveyance efficiency and the field application efficiency are known. Indicative values shown in Table 14 can be used for application and conveyance efficiency if local values are not available.

$$I_{rg} = CWR - (P_e + \Delta SW + \Delta GW) \quad \text{whereas} \quad P_e = P - (P + PW)$$

The basic equation for determining gross irrigation requirements (I_{rg}), considering the conveyance and application efficiency at the field head is;

$$I_{rg} = \frac{NIR}{E}$$

$$E = \frac{Ec \times Ea}{100} \tag{Equation 10}$$

Where: I_{rg}	=	gross irrigation requirement
E	=	Scheme irrigation efficiency
Ec	=	Conveyance efficiency
Ea	=	Application efficiency
CWR	=	Crop water requirement
P	=	Precipitation
PW	=	Deep percolation
P_e	=	Effective rainfall
ΔSW	=	Soil water contribution for crop use
ΔGW	=	Ground water contribution

Example 6:

Given: $I_{rn} = 28.6$ mm, $Eff = 80\%$ and Calculate the I_{rg} or - ?

Solution: $I_{rg} = 28.6 / 0.8 = 35.75$ mm.

Example 7:

We want to apply net depth of 20 mm. The application efficiency with that of furrow irrigation is 40 %, and with sprinkler irrigation is 65 %. How much water do we need to apply with that of furrow and sprinkler irrigation methods?

Solutions:

(1)Furrow: $I_{rg} = I_{rn} / Ea = 20 / 0.4 = \underline{50}$ mm; and sprinkler: $I_{rg} = I_{rn} / Ea = 20 / 0.65 = \underline{30.8}$ mm.

6.6.2 Net irrigation requirement

The net irrigation requirement (net water depth application) is the depth of irrigation water needed to replenish the soil water deficit at the effective root zone to field capacity. The net irrigation requirement for a crop maintained without water stress for any time period can be determined through the following relationship. Net irrigation water requirement (NIWR) is the depth of water, exclusive of effective precipitation, stored soil moisture or ground water that is required for meeting crop evapotranspiration for optimum crop production and other related uses. Such uses may include water required for leaching, frost protection, cooling and chemigation.

This may be expressed as:

$$NIR = ET_c - (Pe + Ge + Wb) \quad \text{(Equation 11)}$$

Where NIR	=	Net irrigation requirement
ETC	=	Crop water requirement
ETO	=	Reference crop evapotranspiration
Kc	=	Crop coefficient
Pe	=	Effective precipitation
Wb	=	the available stored soil water at the beginning of the period
Ge	=	Groundwater contribution
LR	=	Leaching requirement

Sometimes the contribution of ground water, the available stored water at the beginning of the irrigation period and ground water contribution may not be significant. In this case, in determining the net irrigation requirement it is important to consider the effective rainfall. Therefore, net irrigation requirement may be expressed as:

$$NIR = ET_c - Pe \quad \text{or} \quad ET_c = ET_o \times K_C$$

6.6.3 Total crop water requirement for the growing season

Total scheme water requirement is the amount of water pumped or diverted through the scheme inlet that is required for the crops from beginning of land preparation to harvest of the crops for its

optimum growth and increased yield. It includes the losses that occur in conveyance systems and in the farm application systems (including losses to deep percolation, evaporation, and surface runoff, as well as leaching requirements). This can be expressed as:

$$TCWR = \sum_i^n I_{rg} \quad (\text{Equation 12})$$

Where: TCWR = Total scheme water requirement for the growing season,

n = Number of irrigation application during the crop season

I_{rg} = gross irrigation requirement, cm

Crop: Pepper

Soil type: Loam

Planting date: 1 January /length of growing period = 150 days/

Table 9. Sample calculation of crop water requirement

Code	Parameter	Symbol	Operation	Unit	Months												D
					J	F	M	A	M	J	J	A	S	O	N		
1	Reference evapotranspiration	ET_0	ET_0	mm/day	4.4	4.3	5.1	4.8	4.7	4.8	4.2	4.2	3.7	4.5	4.4	4.2	
2	Length of growing period	LGP			150												
3	Crop factor	Kc			0.35	0.65	1.0	1.0	0.90								
4	Crop evapotranspiration	ET_c	(1) x (3)	mm/month	46	84	153	144	127								
5	Rainfall	P	Station	*	18	31	29	46	66	78	126	110	96	37	-	-	
6	Effective rainfall	Pe	(P x 0.7) - 10	*	13	22	20	32	46	55	88	77	67	26	-	-	
7	Net irrigation requirement	NIR	(4) - (6)	*	33	62	133	112	81								
8	Scheme irrigation efficiency	E	50	%	0.5												
9	Gross irrigation requirement	GIR	(7) / (8)	mm/month	66	124	266	224	162								
10	Total crop water requirement for the growing season				842 mm (= 842 mm x 10 m ³ = 8 420 m ³ /ha)												

NB: Follow the same crop water requirement calculation procedure explained in this manual under 6.3.4 under example 4, on page 39.

Module 6

Objectives:

After reading this chapter, readers and/or participants will be able to:

- understand the requirements of each irrigation method, their suitability and limitations for different crops and soil types;
- describe the factors that should be considered for selection of appropriate irrigation methods

Proper irrigation water management aims at optimum and efficient use of water for best possible crop production keeping water losses to the minimum. Water is applied to the soil surface by a number of various irrigation methods. These irrigation methods are adopted to irrigate crops with the main objective to store water uniformly in the effective root zone soil with the maximum quantity required and ensured water losses to the minimum and sustain crop production with the desired quality of produce.

7.1 Classification of Irrigation Methods

The principal methods being used for applying irrigation water to irrigated crops are broadly grouped under: (1) Surface irrigation (wild flooding, border, basin or ring, check basin and furrow); (2) Sprinkler irrigation (resembling artificial rain); (3) Drip irrigation (or trickle irrigation or sometimes called it localized irrigation).

In general, each irrigation method has certain advantages and disadvantages and is adopted based on certain principles. Some methods may be adapted to a fairly wide range of conditions. In some areas, different methods can be profitably adopted and in others, only one specific method is applicable. However, the choice of the most appropriate method to be used should be based on a set of criteria that serve to minimize water losses and increase efficient water management and resulted in increased crop yields. Details of each irrigation method are discussed hereunder.

7.2 Surface Irrigation Methods

Surface irrigation refers to direct irrigation water to irrigating fields by gravity allowing water to flow over the soil surface from a supply channel at the upper reach of the field. It is the dominant and widely practiced method of irrigation, which accounts for about 95% of irrigation systems worldwide and has been used for thousands of years to irrigate a wide range of crops on different soil types. This method, particularly in Ethiopia is considered as the most dominant irrigation method being used among the subsistence farmers and even in state owned irrigated commercial farms. The two basic requirements that need prime importance to obtain high efficiency in surface irrigation methods are *properly constructed water distribution systems* to provide adequate control of water to the fields and *proper land preparation* to permit uniform distribution of water over the irrigated field. Surface irrigation is suited both for small and large farms.

Surface irrigation methods are often selected because they are considered to be simple methods and well suited to the economic conditions of subsistence farmers with little or no basic knowledge of irrigation. It is, thus, hardly surprising that the efficiency of surface irrigation is in the hands of farmers who have no control over farm discharges and the timing of applications are poor. In contrast to its management, the design of surface irrigation layouts for basins, borders, and furrows and their construction is relatively simple and no special materials are required. The maintenance of the system too is less problematic and can be done locally by the farmers themselves. However, the surface method as compared to other irrigation systems, results in the highest water losses, mainly due to surface runoff and deep percolation. In this case, the crop being irrigated does not utilize much of the water supplied. Other losses often occur as a result of water transmission through open channels, due to seepage and evaporation. Therefore, the method should only be used where there is a reliable water source available, and where irrigation abstractions do not adversely affect the environment and downstream users. Various crops in Ethiopia are irrigated mostly by surface irrigation methods. In general, there are five commonly used surface irrigation methods; namely, *wild flood irrigation, basins or ring, check basins, border irrigation, and furrow irrigation.*

Advantages of surface irrigation methods are: (i) The land surface is either completely or partially wetted while irrigating the crops; (ii) surface irrigation methods are widely being practiced in areas where lands are subdivided into Small plots and farmers are relatively poor, like in the Ethiopian condition; (iii) variable sizes of streams can be used; (iv) cost of water application is quite low and sufficiently skilled personnel are not required. In the contrary, limitations of surface irrigation methods are: (i) considerable land is wasted for the construction of channels and bunds, (ii) cost of construction of reservoirs, water courses, field channels and bunds are quite high, (iii) lining of channels and water courses to minimize seepage involves considerable cost, (iv) require frequent maintenance and interference of channels and bunds with other farm activities.

7.2.1 Check basin irrigation

Check basin irrigation method consists of dividing the field into several relatively level plots called checks surrounded by low soil bunds (figure 4). Small checks are level, while bigger ones are slightly sloping along the length. Water is conveyed to checks by a system of supply channel, laterals and field channels.

Check basin irrigation is the simplest and most widely used of all surface irrigation methods because of its simplicity. It is, therefore, most suited to flat lands with soil types having moderate to slow infiltration rates, but can be used on sloping land, provided that the soil is deep enough to allow leveling without exposing the subsurface soil. Small ridges or dikes of earth 30 to 50 cm high are constructed around the area to form the check basin. The size of basins depends on the slope, the soil type and the available water flow to the basins. In this regard, the size of the basins are small when the slope of the land is steep, in sandy soils, with small stream size and low depth of application is required and if field preparation is done by hand. This type of irrigation is, generally used with crops that can withstand contact with water for long periods (such as rice, closely spaced grain crops and deep- rooted fodder crops such as alfalfa, vegetables). However, the method is specially suited to grain and fodder crops in heavy soils where water is required to stand for comparatively a long time to ensure adequate infiltration. It may be adapted to very permeable soils with small checks that must be covered with a large stream for a short time to avoid deep percolation losses at the upstream side. In addition, the method is most suited for leaching of salts from the soil profile, particularly from the active root zone, where the salt damage is critical.

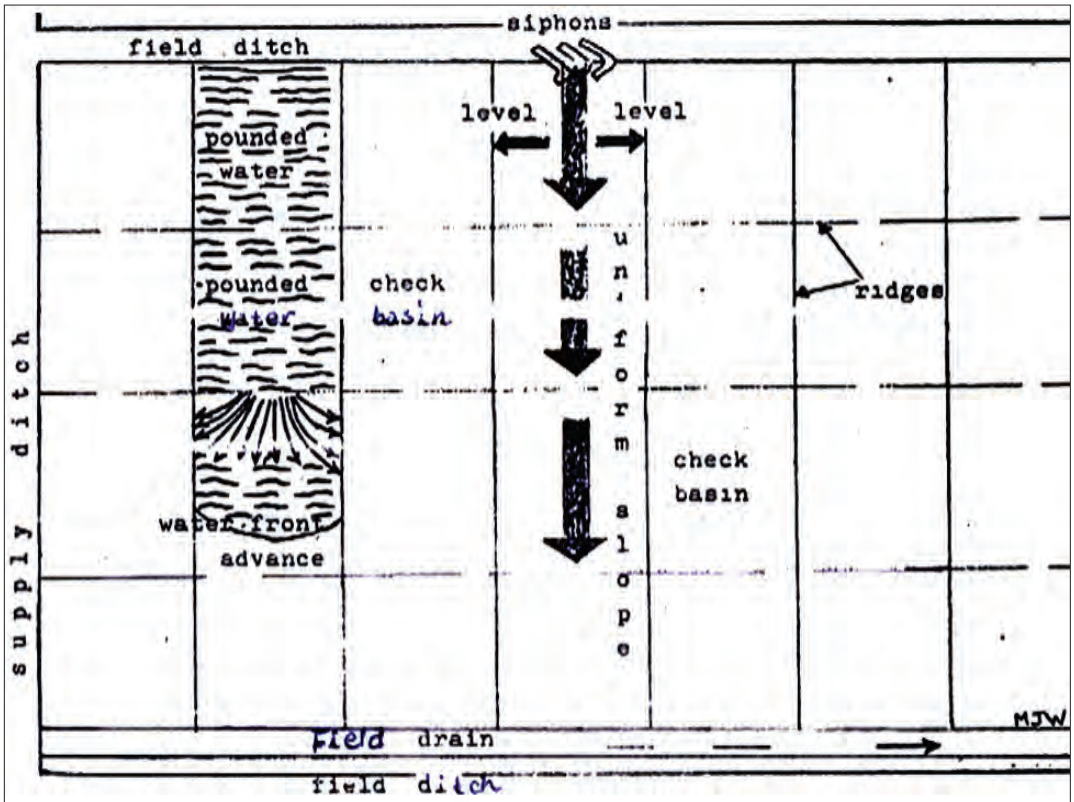

Figure 6. A diagram showing a layout of check basin system of irrigation (Source: Irrigation Agronomy Manual, former MoA/ADD, March 1990, Addis Ababa)

Advantages of the method are: Variable sizes of streams can effectively be used; it can be adopted for a wide range of soils; water application efficiency is high as compared with wild flooding; no loss of water by run-off; rain and irrigation water can be used for wetting the active root zone soil; water logging conditions can easily be created, which is favourable for rice cultivation and leaching down of salts can easily be done. The principal limitations of the method are: Interference of the ridges with other farm activities, considerable land is wasted, which occupied by ridges and lateral field channels, impedes surface drainage, since the land is flat and ridged, precise land grading and leveling are necessary, labour requirements for land preparation and application of irrigation water are much higher, high initial capital investment as compared with other surface methods and the method is not suitable for irrigated crops sensitive to wet soil conditions.

7.2.2 Border irrigation

Border irrigation is a sub-system of controlled flood irrigation in which the land is divided into parallel border strips demarcated from one another by earth ridges. Water is successively delivered into each strip from a head or field ditch at its upper end. The method is designed in such a way that a sheet of water advances down the border and covers all the plots uniformly. As indicated above a field is divided by borders into a series of strips 3 to 30 m wide and generally from 60 to 300 m long. The size of the border is governed by the stream size, land slope, soil type and water

intake rate of soil. The width of a border strip depends on the size of stream and the degree of land leveling practicable. When the size of the stream is small, the width of strip is reduced. The length of a border strip in sandy and sandy loam soil varies from 60 to 120 m in order to reduce losses through deep percolation, in medium loam soils 100 to 180 m and in clay loam or clay soils from 150 to 300 m. In terms of slope, the optimum is in between 0.2 to 0.4 percent, although much steeper slopes are possible with great care to control erosion by applying only small volumes of water.

The land is leveled between side ridges to make the irrigation water run in a narrow sheet from the upper to the lower end of the field. When irrigation starts, the infiltration rate is high at the upper end of the border, but as the soil becomes saturated, the leading edge of the water continues to move downhill. Its rate of forward movement depends on soil type, slope, and quantity of water released. To provide enough water at the lower end of the field without over watering the upper end, a high ridge is constructed at the lower end to hold back a pool of water to irrigate the lower end after the supply is cut-off. The levees or ridges forming the borders to the strips should be 20 to 25 cm high on average. When irrigating, each strip is flooded at the upper end and when the irrigation water has progressed to about 80 percent of the length of the border, recommended to cut-off the irrigation water and let the residue pound to irrigate the lower end.

Border method may be adopted in soils of variable texture. It is, however, suited to soils having moderately low to moderately high water intake rates. This type of irrigation is best suited for close growing crops, such as small grains /wheat and barley/, maize, potato, some vegetables /beet, radish/, alfalfa, and grasses. The border method of irrigation has some advantages and limitations. The main advantages are: less land is wasted for making ridges and channels, efficiency of water application is relatively high as compared to wild flooding, variable stream size can be used and labour requirement is quite low. The limitations are: Precise land leveling is essential; initial cost of land preparation and land grading is high; the method is unsuitable for uneven and undulating land with shallow soils and required more skilled labour.

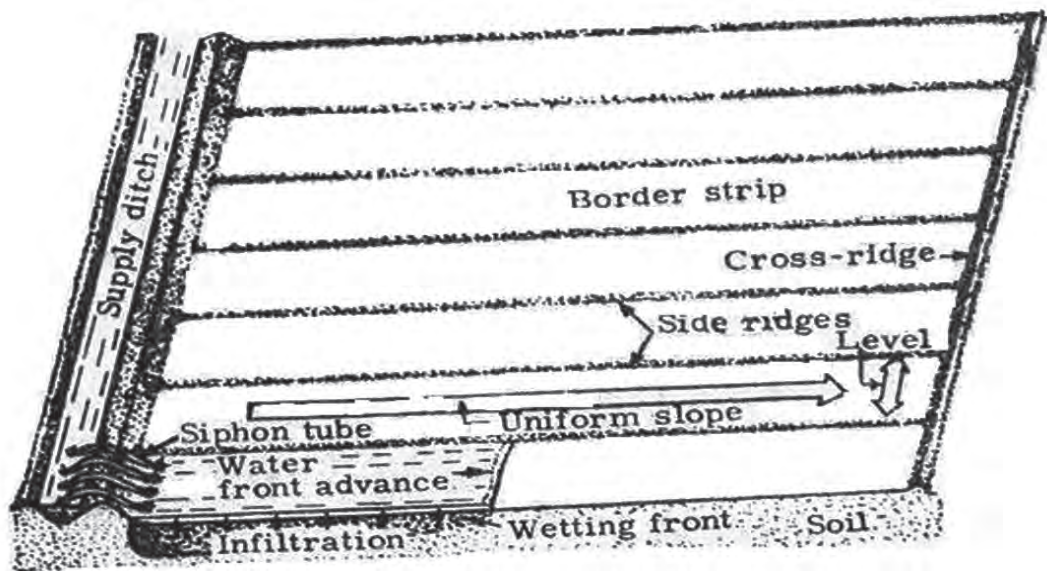

Figure 7. Border Irrigation; (Source: A.M. Michael, Irrigation theory and practice. First edition, 1978, New Delhi)

7.2.3 Basins and ring irrigation

Fruit crops in orchards are irrigated by constructing basins or rings around trees. Basins are usually used for small trees, while rings are used in bigger tree, which are widely spaced. Both methods involve only practical wetting of the soil surface. A considerable amount of water is saved and the irrigation efficiency is found to be high. A young tree may initially be irrigated by the basin method (fig. 8) and then later when it grows bigger it can be irrigated using the ring method (fig. 9). A basin is usually made for one tree sapling, but it may include more than one tree sapling when they are not spaced very wide. Basins may be square, circular or rectangular. When basin encompasses more than one tree sapling, it takes a rectangular shape. Basins are made longer and wider as saplings grow in size. The soil inside the basin is flat with the base areas of trees kept little raised so that the stem of the tree don't come in direct contact with the water, only part of the land is flooded. Water supplied through laterals and each basin is connected to a lateral with a short and narrow furrow. A lateral or field channel passes between two rows of trees alternatively supplying water to individual basins on both sides.

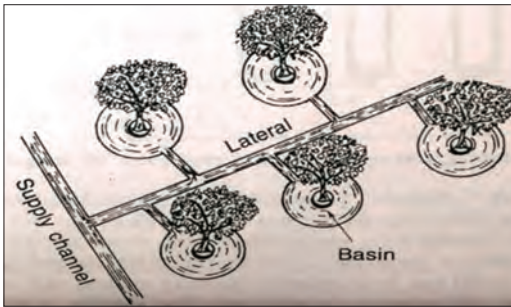

Fig. 8. Basin irrigation method

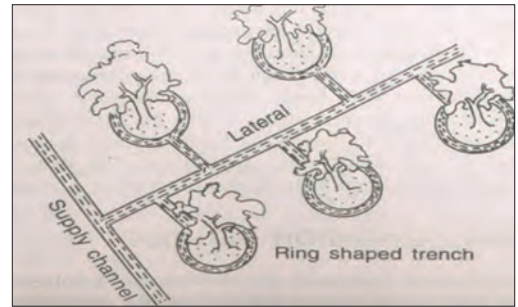

Fig. 9. Ring irrigation method

Source: Irrigation water management principles and practice, Delip Kumar Majumdar, New Delhi, 2000.

Advantages: (1) a considerable amount of irrigation water is saved; (2) it involves only partial flooding of the soils surface; (3) water losses through deep percolation and evaporation greatly reduced; (4) variable sizes of streams can easily be controlled; (5) water application efficiency is very high and (6) the labour requirement for making basins are low. *Disadvantages:* (1) the method is only suited to orchards or fruit trees; (2) basins and channels somewhat restrict the movement of animals and farm implements. Ring method consists of irrigating of fruit trees in orchards by constructing circular trenches around trees. Ring trenches are smaller in both depth and width around small trees and are larger around bigger trees. Rings are prepared considering the canopy development of a fruit tree consideration.

7.2.4 Furrow irrigation

Furrow irrigation refers to irrigating land by constructing furrows between two rows of crops or alternately after every two rows of crops, particularly for narrow spaced row crops such as onions, cabbage and pepper. In contrast to basin and border irrigations, it involves only wetting part of the surface of the soil and water in the furrow moves laterally by capillaries to the unwetted areas below the ridge and also downward to wet the root zone soil. This reduces

evaporation losses, improves aeration of the root zone, less puddling of the soil surface and permits earlier cultivation after irrigation. Besides, furrow prevents an accumulation of salts near the plant bases, in areas where salts are a problem. Furrow irrigation is, perhaps, the most widely used method for row crops. It is usually practiced on gently sloping land up to 3% in arid climates but restricted to 0.3% in humid areas because of the risk of erosion during intensive rainfall. From a farming point of view furrows should be as long as possible as this reduces the cost of irrigation and drainage and easy for mechanization. The furrow method is well suited both to small and large farms.

In deciding the most practical and efficient length of furrow to be used a number of factors need to be considered, such as the type of soil- coarse texture or clay soil, the size of the irrigation stream, the slope of the land, and the irrigation depth or duration of the water application. In general, furrow lengths range from 60 m to 300 m or more depending on the determining factors mentioned above but the field size and shape of fragmented fields of the subsistence farmers put practical limits on furrow length as well. These factors are in fact interrelated with the texture of the soil determining the infiltration rate and the slope determining the speed at which the stream of water flows down the furrow. In principle, furrow lengths are shorter in coarse soils and longer in heavier soils. In this regard, furrow length is as short as 10- 20 m long in vegetable gardens, while for large mechanized irrigation scheme, where growing deep-rooted crops such as cotton may be up to 500 m. Efficient furrow irrigation always involves run-off and surface drainage system is required down at the end of the furrow perpendicular to it, where excess water drains out from the field. The recommended maximum furrow lengths for different soil types and slopes are given in Table 10.

Table 10. Recommended furrow lengths for different slopes, soil types and net depth of water application, mm

Furrow Slope, %	Maximum flow of water per second (l/sec)	Furrow length (m)								
		Soil types and available soil moisture in mm/m depth of soil								
		Clays			Loams		Sands			
		50	75	150	100	150	50	75	100	
0.05	3.0	120	300	400	270	400	60	90	150	
0.10	3.0	180	340	440	340	440	90	120	190	
0.20	2.5	220	370	470	370	470	120	190	250	
0.30	2.0	280	400	500	400	500	150	220	280	
0.50	1.2	280	400	500	370	470	120	190	250	
1.00	0.6	250	280	400	300	370	90	150	190	
1.50	0.5	220	250	340	280	340	80	120	190	
2.00	0.3	180	220	270	250	300	60	90	150	

Source: Irrigation Agronomy Manual, Revised Version, former MoA /ADD, March 1990, Addis Ababa

It can be understood from the table that furrow lengths are decreased with increasing or decreasing of the slopes. When the slope is increased run- off will increase parallel, particularly on heavy clay soils with low infiltration rate and when the slope is decreased the flow of water will be slow and percolation may be a problem significantly on coarse textured soils with high infiltration rate. Moreover, as the slope increases, the movement of water into the ridges will be decreased, resulting

in water loss at the end of the furrow. In addition, higher velocities of water in the furrow lead to risks of soil erosion. Thus, in deciding a furrow system as with all other surface methods, careful consideration of the aforementioned factors is a must. In order to control or at least minimize erosion, particularly in areas where there is heavy rainfall a particular hazard of irrigation schemes located in highland areas, furrow must have a limited slope and the following guidelines are recommended (see table 11 below).

Table 11. Slope of furrow related to soil type

Soil type	Maximum recommended slope, %
Sand	0.25
Sandy loam	0.40
Fine sandy loam	0.50
Clay	2.50
Loam	6.25

With furrow irrigation, the water is applied to small channels, known as furrows that are between the rows of plants. Water is admitted to the head of each furrow, and the rate of flow is adjusted so that the furrow flows full without overtopping. As the water reaches the end of the furrow, the required amount of water has infiltrated into the soil to satisfy the irrigation requirements. The rate of flow into the furrow depends primarily on the intake rate of the soil and the length of the furrow. Infiltration rates for various soil textures and suitable furrow flow rates per 100 m length of furrow are given in Table 12.

Table 12. Soil Infiltration rates and suitable furrow inflows per 100 m of furrow length /furrow spacing 1 m/

Soil	Infiltration rate, mm/h	Furrow inflow l/sec/100 m length
Clay	1- 5	0.03- 0.15
Clay loam	5- 10	0.15- 0.30
Silt loam	10- 20	0.30- 0.50
Sandy loam	20- 30	0.50- 0.80
Sand	30- 100	0.80- 2.70

Source: Stern, P.H. 1985. Small- scale Irrigation.

In order to determine the correct flow rate per furrow requires testing in the field. A simple advance and recession test can be done. To do this, the irrigation agronomist marks of three points along the furrow - a point near the beginning, the midway point, and a meter from the end of the furrow. The water is directed into the furrow at the desired operating flow rate, and the times when the water passes the three markers are noted. At the end of the irrigation, the irrigation agronomist, using the same points along the furrow, notes the time that it takes the water to infiltrate and regress from the end of the furrow to the beginning. With these two sets of data, the irrigation agronomist plots the advance and recession curves for the flow rate in the furrow (on x-y axis

graph: x-axis is representing the length of furrow and corresponding marks; y-axis is the time) on the same graph paper. If the two curves are more or less parallel to each other, this indicates that the flow and time for the length of furrow, under being tested gave a good water distribution. If this is not the case, the flow rate and/or time of irrigation should be changed. This test should be done for each alteration until the desired results are achieved.

Furrow irrigation adapts better than any other method to crops that are grown in rows with more than 30 cm spacing, such as vegetables, maize, groundnut, sugarcane, cotton, and potatoes. Fruit crops are also irrigated by furrow method. Crop types, farm equipment to be used and planting distances between plants are the factors that determine furrow size and shape. Furrows are usually V-shaped in cross section, 25- 30 cm wide at the top, and 15- 20 cm deep, shallower in lighter soils and deeper in heavier soils. Wider, U-shaped furrows with a greater wetted area are sometimes used on soils with slower water intake rates. Usually, the spacing between furrows is narrower in sandy soils and wider in heavy soils. This is to ensure that water spreads laterally into the soil below ridges and downwards in the effective rooting depth uniformly. Furrow spacing in sandy soils is in a range of 60 to 80 cm, whereas in clay soils 75 to 150 cm and in loam soils 60 to 90 cm. Shallow rooted and transplanted crops using seedlings require small width and shallow depth, while deep rooted crops have wide and deep furrow depth. There are 3 different types of furrow methods: *straight level furrow*, *straight graded furrow* and *contour furrow*.

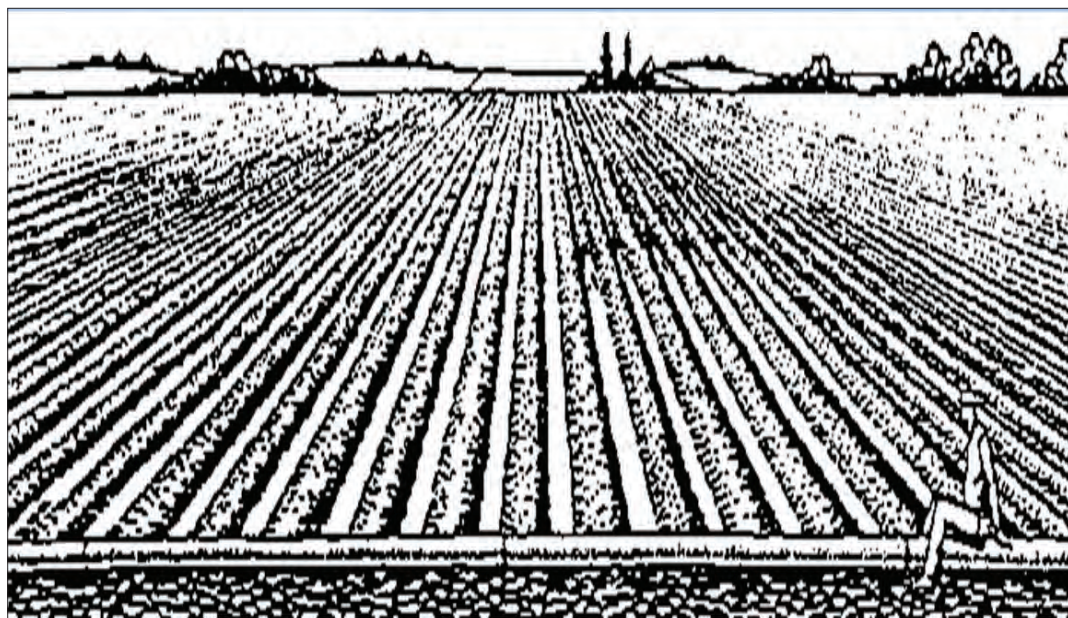

Fig. 10. Level furrow irrigation.

Source: Doneen, L.D., and Wescot, D.W. Irrigation Practice and Water Management. FAO, Irrigation and Drainage Paper. Rome, 1984.

Advantages of furrow irrigation are great saving of water as compared to other surface methods, variable size of stream can be used, the water application efficiency is high as compared to other surface methods, wide range of soils can be irrigated using the method, only part of the land is wetted and losses of water by evaporation, run-off and deep percolation are reduced, sometimes in high rainfall areas furrows can be used as drainage channels and salts are accumulated at the

upper parts of ridges, not significantly affected the growing crop on the middle of the ridges. Principal limitations of the furrow method are land requires precise grading to a uniform slope, labour requirement is high for grading and making furrows, skilled labour is necessary to control water in furrows and the method is not suitable for light irrigation.

7.3 Sprinkler Irrigation

Sprinkler irrigation refers to the application of irrigation water under pressure in which water is sprinkled in the form of spray or simulating artificial rains. This is achieved by distributing the water under pressure through a system of overhead perforated pipelines to various types of sprinkler heads or nozzles fitted to a riser pipes attached to the system of pipes laid on the ground and spray the water from above onto the crop and land. Nozzles of fixed type or rotating under pressure of water are set at suitable intervals in the distribution pipes. Sprinkler systems can be *fixed in place, portable, semi-portable, or mobile*. *Sprinkler nozzle types* and numbers are selected depending on designed application rates and wetting patterns.

Sprinkler irrigation is used on approximately 5% of irrigated land throughout the world. It will never seriously replace surface irrigation but it has advantages over surface irrigation:

- Systems for good water management practices are built into the technology, thus, providing the flexibility and simplicity required for successful operation;
- Independent of the variable soil and topographic conditions, uneven land and steep slopes that can not be irrigated by surface irrigation can be watered without leveling the land;
- Uniform distribution of water in the field can be achieved with high water use efficiency, except in windy condition that distorts the even distribution of water and resulted in uneven distribution;
- Small streams of irrigation can be used efficiently;
- Accurate measurement of the applied water;
- High mobility of the whole irrigation system from one field to another;
- Less interference with subsequent farming operations;
- Least waste of lands for laying out the system, thus, labour cost is reduced;
- Fertilizers, pesticides and herbicides can easily be applied with the irrigation water;
- Controlled water application rate is possible with careful selection of the system;
- Operating procedures are simple and less skilled operator can operate the system;
- Automation is possible with the system as compared with that of the surface methods and
- High yields with good quality fruits and vegetables are obtained under this system.

There are, however, certain disadvantages associated with the method and the principal limitations are: High capital investment for initial installation of the system; operating cost of sprinkler is

high /due to cost of energy/; technical personnel for its operation and maintenance are required; clean water is required in order to avoid clogging of nozzles; sensitivity of the system to windy conditions that distort the uniform distribution of water; water losses by evaporation from soil surface and plant canopy, if wetted and water losses in adjacent border areas wetted by the sprinklers; induction of leaf diseases, due to this fact not suitable for crops sensitive to diseases; hazard of salt accumulation on wetted foliage and requires much more sophisticated design skills and on- farm support in terms of maintenance and supply of spare parts.

Evaporation losses from sprinkler depend on the relative humidity, temperature, wind velocity and fineness of drops that in turn depends on the water pressure and nozzle size. In spite of the fact that more water may be lost through evaporation from the air and plant leaves, still sprinkler irrigation can have a greater efficiency than surface irrigation methods. In sandy soils, especially, it allows more even distribution than furrow or basin irrigation. In clayey soils with slow infiltration rates, the rate of water application for sprinkler irrigation may have to be very slow to avoid surface runoff and soil erosion. Application rates of sprinkler systems need to match with infiltration rate and the slope of the irrigated field. High application rates can result in surface runoff or in ponding and deep percolation losses. Low application rates can be inefficient to meet crop water needs, due to excessive evaporation. Therefore, proper sprinkler system design is essential to achieve high efficiencies with minimal runoff or deep percolation. There are many types of sprinkle system available to suit a wide variety of operating conditions such as permanent, semi-permanent, solid set, semi- portable and portable but the most common one is the portable system using pipes (aluminum or plastic) for supplying water with small rotary impact sprinklers. The efficiency of sprinkler irrigation depends as much on the farmer as on the system. For design purposes a figure of 75% is generally used. Sprinkler irrigation is better suited to large farms rather than the small farms.

Adaptability of sprinkler system

The sprinkler method may be used for many crops and on all types of soils on lands of widely different topography and slopes. However, it finds its best use to irrigate: (1) Sandy soils and soils with high infiltration rates, (2) Shallow soils that do not allow proper land leveling, which critically required for surface irrigation methods can be irrigated using sprinkler system, (3) It suits for areas with steep slopes having erosion hazards, (3) For growing of high value crops and (4) In areas where water is scarce and costly.

Sprinkler irrigation is not suitable for rice and crops susceptible to diseases that can be caused, due to wet conditions. It is not also suitable in soils with significantly low infiltration rates such as in heavy clay soils, which increased losses of water through run- off that, do not have sufficient time to infiltrate. The sprinkler system should be designed to apply sufficient water to meet the crop demands at peak periods of consumptive use when the system is used for full irrigation, particularly in areas with water scarcity. In humid areas, it can be used for supplemental irrigation during the periods of drought. Sprinkler irrigation is also used for protecting crops from frost.

Principal components of sprinkler system

The pumping station is located at the water source, and the pump lifts the water and makes it

available under pressure to the system. The pump is required to overcome elevation differences between the water source and the field, counteracts frictional losses within the system, and provides adequate pressure at the nozzle for good water distribution. A gravity flow system uses the potential energy in an elevation drop to create pressure for its operation. The components of sprinkler system are: (1) *The main line delivers* water from the water source to the field. It may be either permanent or movable; (2) *The lateral pipe delivers* the water from the main line to different sections of the field. The lateral line is usually movable. (3) *The riser delivers* the water from the lateral line to the sprinkler. The length of the riser depends on the crop, although a minimum value of 30 cm is recommended to assure a good distribution pattern. (4) *The sprinkler is* the unit that sprays the pressurized water through an orifice and rotates to distribute water on to the field. (5) *Accessories* are parts of the system that connect all other units together to form a watertight system and these are important parts to an efficient system and should be installed whenever possible.

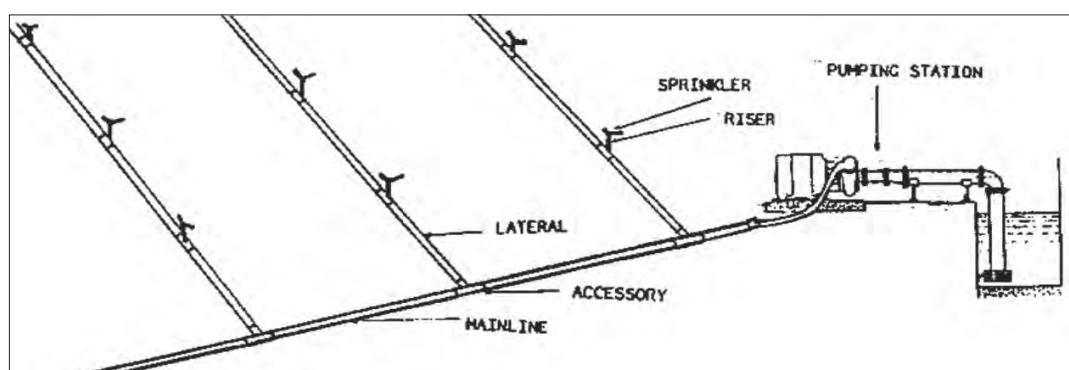

Fig. 11. Typical Sprinkler Irrigation System Components (Source: FAO, Irrigation and Drainage Paper. Rome, 1984)

7.4 Drip Irrigation

Drip irrigation or sometimes called trickle irrigation, refers to the application of water into the soil at slow rates just drop by drop, but frequent and with precise quantities through a small-sized opening called emitters located at, or just above ground level (up to 300 mm and above) directly to the soil surface to irrigate a limited area around each plant. The system suits areas of high temperatures and limited water resources or having high water costs. Drip irrigation is suitable for most soil types and most types of topography. This system allows for the accurate application of water with minimal loss that might occur, due to evaporation, poor distribution and seepage, or over-watering. Drip irrigation as compared with other methods of irrigation is the recent technology developed through intensive research and new development over the past 30 years and least used system on a worldwide scale and involves less than 0.1% of irrigated land in the world. Drip irrigation technologies were developed in Israel, Denmark and USA.

It is the most advanced irrigation method with the highest application efficiency of 90 to 95%. The water is delivered continuously in drops at the same point and moves into the soil and wets the root zone vertically by gravity and laterally by capillary action forming a wetted area like an onion shape. The planted area is only partially wetted. Drip irrigation improves the growth rates of high value crops by delivering moisture directly to their root zones. This saves water because only the important parts of the plants are irrigated. Weed growth is reduced since only the plant is irrigated, and working between the plants is easier because of the dry soil. This technology can be used in

hilly terrain, and is not labour-intensive as it can be automated. The technology can be adapted to use energy-saving components.

A complete drip irrigation system basically consists of a head control unit, main and sub-main pipelines, hydrants, manifolds and lateral lines with drippers or drip emitters /fig.9/ at certain intervals. The components of a drip irrigation system are: (1) *Control station (head control unit)*: Its features and equipment depend on the system's requirements. Usually, it consists of the shut-off, air and check (non-return) valves, a filtering unit, a fertilizer injector and other smaller accessories. (2) *Main and sub-main pipelines*: The main and sub-main pipelines are usually buried, especially when made of rigid PVC. (3) *Hydrants*: Fitted on the mains or the sub-mains and equipped with 2-3- in shut-off valves, they are capable of delivering all or part of the piped water flow to the manifold feeder lines. They are placed in valve boxes for protection. (4) *Manifold (feeder) pipelines*: These are usually 50, 63 or 75 mm. When made of HDPE, they are attached to the hydrants through compression-type, quick release, PP connector fittings and remain on the surface. (5) *Dripper laterals*: These are always made of 12- 20 mm soft black LDPE, PN 3.0-4.0 bars. They are fitted to the manifolds with small PP connector fittings at fixed positions and laid along the plant rows. They are equipped with closely spaced dripper emitters.

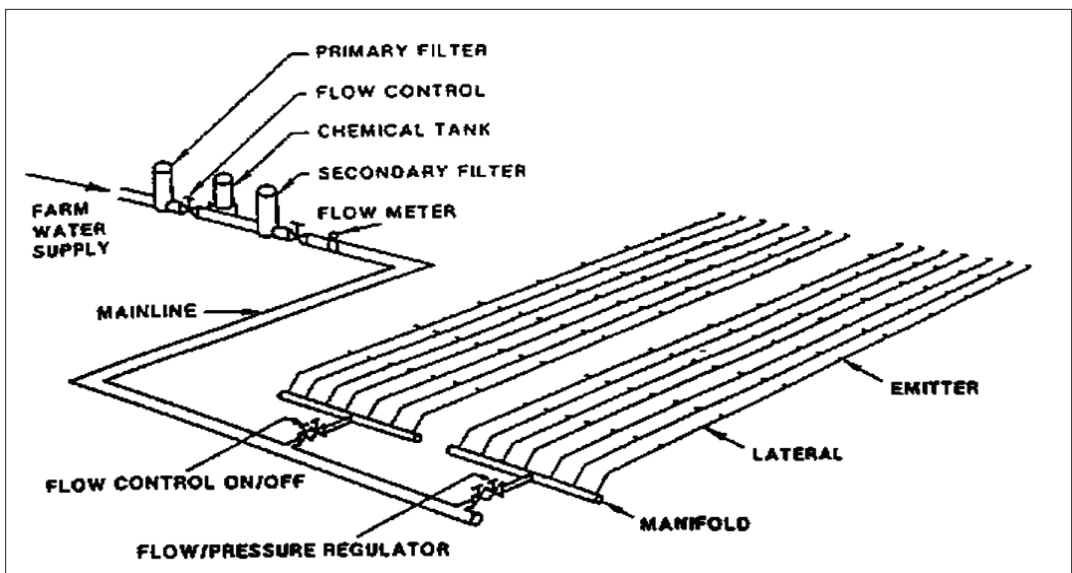

Fig.12. Basic components of a drip irrigation system Source: FAO, Irrigation and Drainage Paper. Rome, 1984)

The drip irrigation method is a proven technology suitable for cultivation of edible (grapes, fruits, and vegetables) and ornamental plants with high commercial values. This system may be used not only to increase soil moisture but to apply fertilizers and micronutrients as well. Crops that can be irrigated using drip irrigation systems include; sugarcane, groundnuts, coconuts, cotton, coffee, grapes, potatoes, and widely spaced fruit crops /papaya, banana, guava and citrus/, closely spaced vegetable crops, and flowers.

Advantages of drip irrigation: (1) More uniform distribution of water and can be obtained higher crop yields; (2) More efficient use of available water or water savings /90- 95% efficiency/, minimal evaporation losses and deep percolation is entirely avoided; (3) Reduced cost for fertilizer and

other chemical application, particularly nutrients can easily be applied with the irrigation water / fertigation/; (4) Low labour operating requirements, reduced cultivation, control, and labour cost for leveling; (5) Low energy requirement as compared with sprinkler system; (6) Utilization of saline water resources, as a result reduced salinity hazard and possibility of using poor quality without causing significant hazard to the crop; (7) Possibility of using marginal lands with soils such as porous and shallow depth; (8) Physical soil conditions are maintained; (9) It is well suited to small and varied plots on small farms, (10) Weeds and pest problems are at minimum; (11) Well-adopted in sloping lands and irregular topography without causing erosion; (12) Lesser amount of tillage operations and a possibility of uninterrupted operation; (13) Not susceptible to wind and more flexible.

However, drip irrigation system has also its limitations: Initial cost is high, particularly for installation of the conventional drip system; required more skilled labour in design, management and maintenance; clogging of emitters and lateral blockage from sand and silt, chemical precipitation from groundwater and algae from surface water is the most serious problem; restricted root zone and the plant may be susceptible to logging, due to poor plant anchorage; salt accumulation in the root zone that required leaching periodically; exposed to mechanical damages; lack of influence on the micro- climate and poor germination may result.

7.5 Selection Criteria for Suitable Irrigation Methods

Factors to be taken into consideration in selecting the most appropriate irrigation methods are: (1) The type of crops to be grown and their rooting depth; (2) Soil characteristics of the land to be irrigated such as type, depth and infiltration; (3) Topography of the land- slope and roughness; (4) Available sources of water and size of the stream supplying irrigation water; (5) Amount of water to be applied during each irrigation; (6) Length of run and time required for wetting the command area; (7) Depth of water table; (8) Labour requirements and its availability; (9) Energy demand; (10) Efficiency of the methods; (11) Initial investment cost and (12) Possible erosion hazard are the main points to be considered in the selection criteria. The main selection criteria to be used for different irrigation systems are summarized in Table 13.

Table 13. Technical factors affecting selection of irrigation method

Irrigation method	Crops	Soils	Labour (h/ha/irrig.)	Energy demand	Potential efficiency, %	Capital cost
• Basin	all crops	clay, loam	0.5- 1.5	low	60	Low
• Border	all crops except rice	clay, loam	1.0- 3.0	low		
• Furrow	all crops except rice and drilled crops	clay, loam	2.0- 4.0	low		
Sprinkler	all crops except rice	loam, sand	1.5- 3.0	high	75	medium
Drip	row crops, orchards	all soils	0.2- 0.5	medium	90	High

Source: Guidelines for water management and irrigation development, FAO, 1996.

Module 7

Objectives:

After reading this chapter, readers and/or participants will be able to:

- **understand the stages of irrigation water use efficiency;**
- **describe the methods of enhancing irrigation water use efficiency.**

8.1 Enhancing Irrigation Efficiency in the Water Abstraction and Conveyance Systems

In a dynamic system such as irrigation where certain inputs are fed into the system and certain outputs are realized, the effectiveness of the system is evaluated by the conversion factor known as “efficiency of the system”. Irrigation efficiency indicates how efficiently the available water supply is being used for crop production based on different methods of application. The fact is that water is a precious and limited natural resource that requires a systematic and wise use of it with the ultimate objective of benefiting all the users on equitable basis for increased crop yield. Water is usually conveyed from the water source through the canal network and field channels to crop fields. Irrigation is applied to store the required water in the effective root zone for crop use. Not all the water diverted from the source reaches the active root zone of crop plants. Considerable losses are occurred during transportation through the conveyance and distribution systems and only limited amount of water is reaching the active root zone and eventually used by the crop.

There are different factors that contribute for the loss of water within the conveyance and distribution systems in a given irrigation project. The loss of irrigation water usually occurs in the conveyance and distribution systems; non- uniform distribution of irrigation water over the field, due to poor leveling of the field; percolation beyond the rooting zone as a result of over- watering; run- off at the tail end of furrows and borders and loss through evaporation like in the case of sprinkler irrigation system. The design of the irrigation system, the degree of land preparation, irrigation methods selected and the skill and care of the irrigator are among the principal factors that influence the irrigation efficiency. However, these losses can be maintained to the minimum by adequate planning of the irrigation system, proper design of the irrigation method, adequate land preparation and efficient operation of the system. Therefore, considering the importance of this valuable but limited resource- the water, it is strongly recommended to use this limited resource as efficiently as possible and obtained the required yield. Irrigation efficiency of surface irrigation methods therefore, depends on different factors as it has been explained above and it varies from 40- 70%.

Different irrigation efficiencies are highlighted as follows for a better understanding of the losses.

These losses occurred at different levels are expressed in percentage of irrigation water diverted from the source.

Stages of irrigation water use efficiency

Irrigation water use efficiency is normally sub-divided into a number of stages, each of which affected by different set of conditions. The following stages of efficiency are considered to be the most important.

a) Water conveyance efficiency (E_c)

This is the loss, which occurred through the conveyance systems from the diversion point to the field where the water is to be used. Notably, it is the ratio between water received at the inlet to the field and the amount of water diverted from the source and computed as:

$$E_c = \frac{W_f}{W_d} \times 100 \quad \text{(Equation 13)}$$

Where: E_c = Water conveyance efficiency (%)
 W_f = amount of water delivered to the farm
 W_d = amount of water Pumped/diverted from the

source

In the water conveyance systems water loss occur as evaporation, seepage in unlined channels, through transpiration and leakage through the water control structures in the conveyance system. The average efficiency is about 50% but it can be increased to 70- 90 % by minimizing the conveyance losses through adoption of appropriate measures. Therefore, in order to increase the water conveyance efficiency the following measures can be taken:

- Lining of canals, water ways and channels with impervious materials;
- Regular maintenance of cracks, holes, burrows, damages and leaks in water control structures;
- Control of weed growth in the unlined canals, waterways and field channels.

Table 14: Indicative values of conveyance efficiency (%)

Permeability of canal Banks	Earth canal		Low (clay)	Lined canals
	High (sand)	Medium (Loam)		
Scheme size (ha)				
Large (> 2000 ha)	60	70	80	95
Medium (200-2000 ha)	70	75	85	95
Small (< 200 ha)	80	85	90	95

b) Water application efficiency (E_a)

Water is applied to the crop field for moistening the soil to field capacity and storing the water in the soil pores for crop growth. This is a form of loss of water occurred through field application after the water reaches the field supply channel and it is the ratio between water directly available to the crop and the amount of water received at the field inlet and computed as:

$$E_a = \frac{W_s}{W_f} \times 100 \quad (\text{Equation 14})$$

Where: E_a = Water application efficiency, (%)
 W_s = amount of water stored in the active root zone of the plants during irrigation
 W_f = amount of water delivered to the farm

The field application efficiency (E_a) mainly depends on the irrigation methods being used and skill of the farmers. This efficiency is determined to evaluate the efficiency of irrigation practices in the farm. Losses occur in the form of seepage in the supply channel, deep percolation and sometimes as run-off. Water loss resulted, due to improper land leveling and grading, an appropriate choice of irrigation methods, application of excess water, frequent irrigation, and application of small or large stream sizes, design faults and inadequate attention by the irrigator. Therefore, proper land leveling and grading is a prerequisite for efficient water application. This is highly required in order to avoid accumulation of excess water in the lower spots that leads to deep percolation loss and under-irrigation of higher spots and to achieve uniform run and distribution of water in the field. Proper selection of irrigation method based on the crop and soil types, topography, climate and stream size are important factors to be considered to secure high efficiency through uniform application of irrigation water and preventing deep percolation and run-off losses.

Table 15: Indicative values of field application efficiency (%)

Irrigation methods	Application efficiency (E_a)
Surface irrigation (basin, border, furrow)	60
Sprinkler irrigation	75
Drip irrigation	90

c) Water storage efficiency (E_s)

Water storage efficiency refers to the percentage ratio of the amount of water stored in the effective root zone soil after irrigation (W_s) to the amount of water needed to refill the root zone to its field capacity. It is expressed as percentage and is based on a given soil moisture depletion percentage of the available water holding of the root zone or the moisture deficiency at the time of irrigation. Low financial return from irrigation often occurred not only because of excessive water application but also because of insufficient application and computed as:

$$E_s = \frac{W_s}{W_e} \times 100 \quad \text{(Equation 15)}$$

Where: E_s = water storage efficiency, (%)

W_s = amount of water stored in the active root zone of the plants during irrigation

W_e = amount of water needed in the root zone prior to irrigation

d) Water distribution efficiency (E_d)

One of the important characteristics of irrigation is uniform distribution of water throughout the root zone. Under most conditions, the more uniformly water is distributed the better will be the crop response and it is computed as:

$$E_d = 100 \left(\frac{1-y}{d} \right) \quad \text{(Equation 16)}$$

Where: E_d = water distribution efficiency, (%)

y = average of numerical deviation of water stored in depth of water stored in root zone soil

d = average depth of water stored in the root zone

e) Consumptive use efficiency (E_{cu})

The water stored in the root zone for the purpose of crop consumption may be subsequently lost through deep percolation and excessive surface evaporation especially at higher efficiency. A scheme irrigation efficiency of 50- 60% is good, 40% reasonable, while a scheme irrigation efficiency of 20- 30% is poor. The ratio of the water that is actually consumed by the crop to the water stored is called “consumptive use efficiency”. This is computed as:

$$E_{cu} = \frac{W_{cu}}{W_a} \times 100 \quad \text{(Equation 17)}$$

Where: E_{cu} = Consumptive use efficiency, (%)

W_{cu} = water consumed by the crop

W_a = water stored in the soil and subsequently depleted

f) Water use efficiency (Eu)

The water utilized by the crop is generally, described in terms of water use efficiency which expressed in kg/ha-cm or q/ha- cm. The quantity of water used on the project farm or field out of the quantity delivered is calculated as:

$$E_U = \frac{W_u}{W_d} \times 100 \quad \text{(Equation 18)}$$

Where: E_u = water use efficiency, (%)

W_u = water beneficially used

W_d = water delivered

The water use efficiency is important in crop production and water management practices. It is described in the following two ways:

(I) *Field water use efficiency*: this may be defined as the ratio of the amount of economic crop yield to the amount of water required for crop growing. It is computed as:

$$E_u = \frac{Y}{CWR} \quad \text{(Equation 19)}$$

Where: E_u = water use efficiency, (%)

Y = economic crop yield in kg/ha

CWR = crop water requirement

(II) *Crop water use efficiency*: this may be defined as the ratio of the economic yield of a crop to the amount of water consumptively used by the crop. It is computed as:

$$E_u(WUE) = \frac{Y}{CUorET} \quad \text{(Equation 20)}$$

Where: Y = economic crop yield in kg/ha

CU = consumptive use of water expressed in ha- cm or ha- mm

ET = evapotranspiration of a crop expressed in ha- cm or ha- mm.

Once all the irrigation water efficiency types have been determined the project irrigation efficiency E_p can be calculated using the formula:

$$E_p = \frac{E_c \times E_a \times E_s \times E_d \times E_{cu} \times E_u}{100} \quad \text{(Equation 21)}$$

Where: E_p = project irrigation efficiency (%)

E_a = field application efficiency

E_s = water storage efficiency

E_d = water distribution efficiency

E_{cu} = consumptive use efficiency

E_u = water use efficiency

Therefore, it is highly important to note that irrigation systems should be managed properly throughout in order to achieve the maximum efficiency of the system. This clearly indicates that how efficiently the available water supply is being used for crop production based on different methods of application. Water is a precious and limited natural resource that requires a systematic and wise use of it with the ultimate objective of benefiting all the users on equitable basis for increased crop yield. In this regard, the water abstraction and conveyance systems through the canal network and field channels to crop fields need to be maintained properly. Properly maintained systems are therefore, a necessity to maximize the efficiency of the system. These of course, include proper planning and design of the irrigation system and maintaining periodically water measuring structures at the diversion and/or use of the appropriate water abstraction methods, properly maintaining of the water conveyance systems including distribution systems.

8.2 Applying of Improved on-farm Water and Crop Management

Water losses can be maintained to the minimum by adequate planning of the irrigation system, proper design of the irrigation method as it has been described above under 8.1. In addition, the degree of land preparation, irrigation methods selected and the skill and care of the irrigator are also among the principal factors that influence the irrigation efficiency. In this connection, proper operation and maintenance of the irrigation systems play significant role in enhancing irrigation water use efficiency. Therefore, considering the importance of this valuable but limited resource-the water, it is strongly recommended to use this limited resource as efficiently as possible and obtained the required yield.

Field water use efficiency is of great importance to farmers and the planners, while crop water use efficiency is of great importance for the agronomists and researchers. Water use efficiency is influenced by changes on the economic crop yield in one hand that depends on various factors of crop production practices (climatic conditions such as amount, distribution and intensity of rainfall, occurrence of drought, soil characteristics, drainage, irrigation practices, fertilizer use, crop varieties, crop and pest management practices; weather hazards and environmental conditions. The crop water requirement or evapotranspiration is also influenced by various factors such as plant and soil types, climatic conditions, and soil and crop management practices applied. Therefore, an increase in crop yields or a decrease in CU and ET of crops improves the water use efficiency. Similarly, the consumptive use or evapotranspiration of crops influenced more or less by the same factors that influence crop yields, including use of mulch to conserve soil moisture.

Maximum crop growth and yield are obtained when soil water supply and other crop management practices maintained at optimum. Limited supply of water can be best used to obtain the maximum use efficiency and crop yields by irrigating crops only at the most sensitive physiological stages of crop growth, particularly in areas where water is scarce resource and improving food security is the prime focus areas.

Crops much differ in their water use efficiency. Crops like rice, wheat, barley, oats, potato, oilseeds and pulse crops have low water use efficiency coupled with low photosynthetic rates. On the other hand, crops like sugarcane, maize, sorghum and millet have high water use efficiency coupled with a higher rate of photosynthesis. Drought tolerant crops like pineapple and the like consume much less water. Therefore, in order to economize water and to produce maximum crop yields with the

available irrigation water, it is always important to grow crops that are efficient users of water and at the same time give reasonable yields. In this regard, in areas of water scarcity, crops producing more yields per unit of water are preferred to be included in the cropping system rather than crops that give higher total yields.

Therefore, in conclusion in order to enhance efficiency of irrigation and water management it is highly important to pay special attention to the following: (i) Adequate planning and proper design of the irrigation system, (ii) Adequate maintenance of the conveyance and distribution systems, including regular clearing of weeds growing along the main and field channels, (iii) Maintain proper land preparation for uniform distribution of on-farm irrigation water, (iv) Selecting of appropriate irrigation methods by taking into consideration the predetermining factors for selecting proper irrigation methods such as crop types, soil types, topography of the area, cost of the irrigation method under consideration and skills of the users, (v) improved on-farm irrigation water management by putting in place and maintaining of field water measuring devices, regular maintenance of field distribution channels from weeds and avoiding of water losses through seepage and evaporation, (vi) Application of improved crop management practices such as crop and variety selection, land preparation, planting method, time of planting, water application to satisfy the crop needs, irrigation method being used, fertilizer application, weed and crop pest management practices, etc.

Module 8

Objectives:

After reading this chapter, participants will be able to:

- describe the factors affecting irrigation scheduling
- understand the major criteria for irrigation scheduling for optimum use of water resource
- determine the irrigation scheduling for major irrigated crops

Irrigation scheduling refers to the development of schedules for the application or distribution of seasonal or total irrigation water requirement during the growing period of a given crop. In practice, it is the application of irrigation water at the time of actual need of the crop depending on the availability of water over the growing period of the crop with just sufficient water to wet the effective root zone soil. The interval between two irrigations should be as wide as possible to save irrigation water, of course, without affecting adversely the crop growth and yield. Scheduling of irrigation is considered to minimize the losses of irrigation water, due to evaporation, leaching, seepage, etc and to maximize the efficient use of available water resources.

Therefore, on-farm irrigation water management involves the manipulation of such factors as the timing and amounts of irrigation water to be applied to the crop, the flow rates to be used, and the methods of controlling the water. The principal aim is to obtain maximum crop yield by making the most efficient and economic use of the available water. Proper irrigation water management, therefore, can help to reduce the unwise use of irrigation water and energy consumption, thus, making these supplies available for irrigating more land, as well as decreasing the cost of the system. It can reduce the loss of fertilizer, caused by leaching from the effective root zone with excess water application and consequently maximizes the efficient use of fertilizer applied to achieve the desired yields. A good management program ensures that root zone salinity is controlled at desired levels and parallelly waterlogging of soils and excess deep percolation losses are either diminished or eliminated. It can also help to eliminate problems such as erosion and control crop diseases resulted, due to excessive or deficient water application. In general, a good farm water management program can enable farmers consistently make the best use of the available water.

In setting up an effective irrigation water management program, there is a need for irrigators' intimately to be familiar with the irrigation system under operation and related factors that need to be considered. In this regard, it will be very important to be aware of the different possible modifications in the irrigation water management practices and must know how the changing environment prevails depending on the management factors that will affect the crop and soil system and other operational characteristics. For example, it may be possible to change the rotation and supply of water so that the availability is more in tune with crop requirements.

9.1 Factors Affecting Irrigation Scheduling

Irrigation scheduling is one of the factors that influence the agronomic and economic viability of small farms. Therefore, following proper irrigation scheduling technique is important for both water savings and improved crop yields. The irrigation water is applied to the cultivated field

according to predetermined schedules based upon the monitoring of the soil water status and the crop water need at different growth stages.

Factors such as irrigation method, irrigation system geometry (width, length, depth and spacing), slope, type of soil and topography, crop type, tillage practices, flow rates, irrigation timing and duration and availability of irrigation water need to be considered for modification of on-farm irrigation water management. The soil type and its depth and climatic conditions such as temperature, wind, humidity, and rainfall have a significant effect on the main practical aspects of irrigation, which are the determining factors to estimate how much water should be applied and when it should be applied to a given crop.

Effective irrigation scheduling requires knowledge of: Soil water-holding capacity, current available soil moisture content, crop water use or evapotranspiration (ET), crop sensitivity to moisture stress at critical crop growth stages, availability of irrigation water supply and effective rainfall during the growing period and length of time to irrigate particular field. The very basic questions that should be raised and decided upon are therefore: do I need to irrigate the crop or when to irrigate the crop? And how much water should I apply? If these questions are answered properly, irrigation management will be easy thereafter. Therefore, proper irrigation scheduling based on timely measurement or estimation of soil moisture content and crop water needs, is one of the most important irrigation water management practices. Details of the factors influencing irrigation regime are discussed hereunder.

9.1.1 The soil

The type of soil and its characteristics that significantly affect irrigation water management include its water-holding capacity, the water intake rate and soil erosivity. Soil texture, organic matter content, soil structure and permeability influence these characteristics and may limit producers' or the farmers' management and system options. The water-holding capacity of a soil depends mainly on its texture. Compared with clayey soils, sandy soils have more macropores /large pore spaces/ which don't retain water as that of microspores. In fact, sandy soils can hold only about half as much usable water per unit of depth as clayey soils. This indicates that sandy soils need more frequent but lighter irrigation water applications than clayey soils. Similarly, shallow soils or soils with hardpans or very compacted sub-soils that restrict root depth will require lighter but more frequent irrigation.

Producers or the farmers therefore, should know the predominant soil type in each field receiving irrigation water. The available water-holding capacity should be used with the current moisture depletion status to schedule irrigation. This soil information can usually be obtained locally from soil maps of the area.

9.1.2 Water needs of crops

Crop plants require water to meet the transpiration loss, build up its body tissues and to carry on biochemical and physiological activities within the plants. Transpiration, which is considered as a vital physiological activity of plants, occurs continuously as long as the water supply is maintained and a continuous evaporation occurs from the moist soil surface in crop field. After irrigation, the evapotranspiration begins at peak rate drawing water from the moist soil below and continues till there is available moisture in the soil. However, rate of evapotranspiration decreases continuously sometime after completion of irrigation with reduction in available soil water below the field capacity. A stage is reached within a few days after irrigation when the rate at which soil water is available for extraction by crop plants becomes equal to the normal consumptive use rate. This

stage of soil water is considered as the lowest point of the optimum soil water regime. The *optimum soil water regime* means the range of available soil water in which plants do not suffer from water stress and all the plant activities occur at an optimal rate. A soil water deficit below optimum soil water regime causes water stress in plants causing decline in growth and yield, as the rate of availability of soil water falls short of the normal consumptive use rate. Irrigation, is, therefore, needed when this lowest limit optimum water regime is reached and it is considered as the most fitting time for applying irrigation water to the crop.

Every crop has a characteristic optimum water regime. The regime varies with crop abilities to extract water from different soil layers. In particular, the crop type, depth of roots, and stage of crop growth significantly influence the crop water need. In this regard, deep- rooted crops such as watermelon, eggplant, and tomatoes have better abilities to extract water from deep soil layers and are more resistant to dry spells, while shallow rooted crops such as leafy vegetables /such as lettuce, onion, and the Crucifer family/, short- cycle cereals and others with shallow root systems are extracting water from the upper soil layers, since their active root zones are located on the upper parts of soil layers. Therefore, these shallow-rooted crops need more frequent, but lighter waterings than deep- rooted ones. In principle, all plants will need more frequent and lighter watering when young, whereas their roots grow deeper, watering intervals can be spread out and larger amounts of water are applied per application.

9.1.3 Availability of irrigation water

Irrigation water is often in short supply in most locations and, therefore, it demands a careful and economic use. Economic use of water permits to bring more areas under protective irrigation and leads to a greater crop production in areas of limited water supply. Therefore, in areas with water scarcity, farmers are advised to irrigate their crops giving priorities to critical crop growth stages that are sensitive to water deficit by skipping some irrigations for some stages that do not significantly affect crop yield. It is therefore; necessary that the critical stages of water need of crops should receive the foremost attention. At the same time it is important to consider and weigh the relative importance of the various stages of crops for irrigation and the availability of water, in areas of water scarcity.

9.1.4 Stages of crop growth affecting irrigation practice

Growth of all plants can be divided into three stages with regard to irrigation practice, namely; vegetative, flowering and fruiting. In principle, during vegetative growth stage the water need of crops increases gradually, flowering occurs near and during peak period of consumptive use of water, while that of fruiting is accompanied by a decrease in water use and ceases during the latter part of dry fruiting. Therefore, the amount of water applied and the frequency of irrigation must be adjusted to the actual water need of the crop, the water-holding capacity of the soil and rooting depth. Naturally, a shallow sandy soil will require quite different scheduling of irrigation than a deep clay loam soil having a characteristic of a much larger water storage capacity. In this case, a shallow sandy soil will require quite frequent but light irrigations, whereas a deep clay soil requires less frequent but heavy irrigations.

Irrigation practice during the vegetative stage of growth: Shallow or variable planting depths may require several light irrigations to obtain a good stand while deeper planted crops may require one irrigation or possibly no irrigations, if good moisture is available at planting. Other factors, such as the need to push salts below the seed and seedling, may influence the number of irrigations and amounts of irrigation water to be applied. Crusting of the soil surface may inhibit plant emergence,

thus, one or two irrigations specifically for the purpose of softening the soil to allow uniform seedling emergence may be required. Thus, during vegetative development, the schedule should take into account the change in the soil water reservoir, water use, and crop sensitivity. In addition, factors such as the unevenness of the soil surface, surface methods of irrigation, intake characteristics, and water control may limit the maximum or minimum efficient depth of application. Therefore, a farmer may increase or decrease irrigation intervals and application depths to avoid deep percolation or runoff without affecting crop yields. Irrigation intervals may be increased to avoid leaching of nutrients at this stage. Soil salinity considerations may require greater depths of application for leaching, or closer intervals to dilute the salts in the root zone.

As a rule, a good moisture supply normally should be available to plants at all stages of vegetative growth. It is at this particular stage that the nitrogen fertilizer is essential for normal plant growth and development; therefore, light but frequent irrigations are desirable to keep the soil moist and increase efficient utilization of soil nutrients by the crop. This is particularly true for shallow rooted leafy vegetable crops. But for deep rooted crops it is recommended, less frequent but heavier irrigations. In areas, with high temperatures, frequent irrigations may be desirable for cooling the soil and the plants as well.

Irrigation practice during the flowering and fruiting stages of growth: During mid-season or flowering stage, the soil water reservoir is fully or almost fully developed. Most crops are especially sensitive to moisture stresses at this time, and their potential to use water is greatest. Therefore, during the flowering stage, as explained earlier care must be taken to ensure that adequate moisture is available in the root zone. The irrigation schedule during this part of the season can often be constant if weather conditions are constant. It could, however, vary with changes in crop water use or the amount of effective precipitation. The same factors that influence the maximum or minimum application depths should be considered.

Disease or pest problems that result from frequent irrigations or wet conditions are often reasons for lengthening irrigation intervals. Crop cooling and frost protection may also be factors influencing a schedule, especially in sprinkler irrigation system. In irrigation systems that are used for application of fertilizers, pesticides, or other chemicals, the timing of these may be the overriding consideration for certain irrigations. The fruit setting of many crops occurs sometime during mid-season. This is usually the most sensitive period of the whole crop season; thus, proper irrigation scheduling during mid-season is a key to good production. Therefore, it is important to pay special attention to avoid the soil from drying that might cause flowers to fail to mature into seeds. During the fruiting stage, however, crop yields are not as easily affected as during mid-season. The root system is essentially developed to its maximum depth, water use is decreasing, and the crop is less sensitive to high soil moisture depletions. As a result, irrigations can typically be less frequent and of greater depths. During production of dry fruit irrigation has essentially reducing since the slight water requirement of the crop can meet usually from stored water in the soil. Usually, the last heavy irrigation should be applied during the wet fruiting stage so that deep roots will have the chance to extract the available water during the final development of fruit. However, crops like potatoes and groundnuts require adequate moisture during their entire growth period. In the case of potatoes allowing the soil to become too dry between irrigations causes uneven knobby tubers.

Good aeration is also essential. Sandy loam soils have good aeration as compared with that of clay and silt soils. For this reason, good potatoes are generally produced on sandy loam soils, which can irrigate frequently without creating problems of aeration. It is important to remember that sufficient moisture must be available to fully develop wet fruits, such as tomatoes, green peas, and green maize and deciduous fruits. These fruits or green maize and beans will not be firm and fully formed unless ample moisture is available. However, excessive irrigation during the fruiting period will stimulate

vegetative growth for some crops and result in reduction of fruiting such as crops like cotton. The quality of the crop can often be greatly influenced by the irrigation schedule during this time. The protein content in grains can be increased, potato storage ability is improved, and withholding water as these crops mature increases the sugar content of sugarcane. The color of some crops can be altered. The moisture content of harvest product is a definite consideration, since the last irrigation usually must be scheduled with enough time to allow the soil and crop to dry for harvesting. For root and tops, however, sufficient soil moisture to allow harvesting must be assured. Post-harvest tillage moisture requirements may also be considered at this time.

9.1.5 Critical stages of crop growth to water deficit

There are some crucial stages in the life cycle of a crop plant when the plant is badly in need of water. Allowing water stress beyond a certain limit during these stages of crop growth causes a definite set back to growth processes and that ultimately affected the yield. These stages are referred as the *critical stages of water requirement of crops*. However, this does not mean that these stages are coinciding with peak consumptive use of water by crops. Water stress at these stages causes lower tillering, branching, pegging, tuber bulking, inadequate flowering and in extreme case, flower drops, poor setting of grains or fruits, bad filling of grains or serious fruit drops depending on the type of crops. The critical stages of water need of most crops are indicated in Table 16.

Table 16. Sensitive growth periods to water deficit of major irrigated crops

Crop	Critical growth stages /periods to water deficit
Maize	Flowering > grain filling > vegetative period; flowering is very sensitive if no prior water deficit
Wheat	Flowering > yield formation > vegetative period
Groundnut	Flowering > yield formation, particularly during pod setting
Potato	Period of stolonization and tuber initiation > yield formation > early vegetative and ripening
Onion	Bulb enlargement, during rapid bulb growth > vegetative period /and for seed production at flowering/
Pepper	Throughout but particularly just prior and at start of flowering
Tomato	Flowering > yield formation > vegetative period, particularly during just and after transplanting
Banana	Throughout but particularly during first part of vegetative period, flowering and yield formation
Cabbage	During head enlargement and ripening
Alfalfa	Just after cutting (and for seed production at flowering)
Citrus	Grapefruit, lemon and orange flowering and fruit setting > fruit enlargement for lemon heavy flowering may be induced by withholding irrigation just before flowering
Cotton	Flowering and boll formation
Grape	Vegetative period, particularly during shoot elongation and flowering > fruit filling
Pineapple	During period of vegetative growth
Rice	During period of head development and flowering > vegetative period and ripening
Sugarcane	Vegetative period, particularly during period of tillering and stem elongation > yield formation
Watermelon	Flowering, fruit filling > vegetative period, particularly during vine development
Bean	Flowering & pod filling, vegetative period not sensitive when followed by ample water supply
Pea	Flowering and yield formation > vegetative, ripening for dry peas
Safflower	Flowering and pod filling > vegetative
Sorghum	Flowering > yield formation > vegetative period less sensitive when followed by ample water supply
Soybean	Flowering and yield formation, particularly during pod development
Sunflower	Flowering and yield formation, particularly during bud development
Tobacco	Period of rapid growth, yield formation and ripening

Source: Irrigation agronomy manual, former MoA- Agricultural Development Department, March 1990, Addis Ababa

It is true that crops require adequate water supply throughout their life cycle for best growth and development to obtain optimum yield. Only in the later stages of crop maturity, water supply is reduced or cut-off to obtain uniform and quicker crop maturity. In areas of water scarcity crop allowed standing water stress to some extent during the crop growth period, avoiding critical stages for water deficit to save water.

9.2 Criteria for Scheduling Irrigation

Since irrigation water is of limited supply in most of the places, an emphasis should be given to the most efficient and economic use of water for normal crop production. In a situation, where adequate water is available on the demand, farmers often irrigate their crops earlier than the actual time of need, due to their eagerness to obtain good growth and high yield of crops. However, in reality this does not confirm higher yield of crops, since this may lead to waste of valuable water and even can cause damage to crops, due to over-irrigation.

On the other hand, a delay in irrigation for lack of proper knowledge may lead to water stress that might affect the crop yield significantly. Therefore, optimum scheduling of irrigation based on the crop need of water is considered the right approach to ensure high water use efficiency and obtain a promising high yield of crops. However, since adequate water is not available in most places, attentions must be given to produce the maximum yield per unit of water used by rational distribution of irrigation water among crops over the growing seasons. A thorough understanding of the soil- water- plant- atmosphere relationships is essential for proper scheduling of irrigation, since irrigation need of crops are decided by the evaporative demand of the ambient atmosphere, soil water status and plant characteristics.

The criteria for scheduling irrigation may be grouped into three categories: (1) Plant criteria, (2) Criteria based on soil water status and (3) Meteorological criteria.

Plant criteria

Plants show up certain characteristic changes in their constitution, appearance and growth behaviour with changes in available soil water and atmospheric conditions. These changes are often important indicators for the time of irrigation. These different plant criteria are:

- General appearance of crop plants- change of colour, wilting or drooping of plant parts and curling or rolling of leaves. This technique is, however, quite simple and rapid, but suffers from deficiencies. Changes in colour may be misleading, due nutritional or pest damage.
- Plant water potential and water content of plant tissues- not easily practicable in our condition, due to lack of appropriate equipment;
- Plant growth- cell elongation is considered as the growth process that suffers first with water stress in plant. Subsequently, retardation in growth of height or internodal length occurs. But this requires regular measurement of plant growth. Due to lack of appropriate equipment this is not also practical in subsistence farming like Ethiopia and inadequate standardization of the method;
- Critical periods of water need- irrigation scheduling may be decided based on stages of growth more conveniently in crops in which the physiological stages are distinct and easy to locate the critical stages of growth to water deficit;

- Indicator plant- such as sunflower is used to indicate symptoms of water stress before the crop plant is affected by water stress;
- Stomatal opening- opening of stomata is regulated by soil- water availability. Stomata remain fully open when the water is adequate and partially or fully closed when there is water scarcity in the soil to reduce transpiration;
- Leaf diffusion resistance is also based on the degree of stomatal closure which is regulated by leaf water deficit by measuring leaf diffusion resistance-LDR and
- Plant temperature- with water deficit in plant the temperature of leaf tissue is rises.

Criteria based on soil water status

Scheduling irrigation based on soil water content is the most accurate and dependable method. Determination of the available soil- water is rather more important than estimating the total water content of soils. Soil data that must be known to determine the irrigation scheduling include; the soil water- holding capacity, depths of the different soil layers, and the infiltration characteristics of the soil. Knowledge of soil texture, structure, and organic matter content will also help to determine whether the moisture- holding capacities or the intake rate can be improved. Knowledge of soil salinity and how to control the salt levels is essential as well. Irrigation is applied when the soil water content reaches the lowest point of optimum soil water regime. The optimum water regime for various crops in particular area is determined experimentally by correlating yields with the water contents of different soil types.

Climatological approach

Empirical formulae: Empirical formulae using different meteorological parameters have been developed for estimating the evapotranspiration and consumptive use for controlling irrigation, among which the modified Penman method, Thornthwaite, Blaney- Criddle and Christiansen developed formulae for estimating potential evapotranspiration and then used the estimated evapotranspiration for scheduling irrigation by water budget method. The daily evapotranspiration loss is deducted from the soil water reserve in root zone soil after irrigation and a balance is worked out. When the balance shows that the soil water is depleted to a predetermined level, say, the lower level of optimum soil water regime, irrigation is applied to replenish the water lost through evapotranspiration. The adoption of the empirical formulae for irrigation control demands the knowledge of water-holding capacity of soils and a continuous record of rainfall and other meteorological parameters. However, this approach of scheduling is also more complicated for ordinary farmers and even for experts not having basic know- how of the methods.

Evaporimeter

Evaporimeter, type of US Weather Bureau class- A pan may be used for irrigation control. It is used to measure the evaporation loss, which is used to determine the consumptive use by crops by multiplying the evaporation values with crop coefficient values. Irrigation is applied when crops consume the available soil water to a certain limit calculated on the basis of consumptive use rate as determined by the evaporimeter.

9.3 Frequency and Interval of Irrigation

The terms, frequency of irrigation and interval of irrigation are closely related and are interchangeable. With higher frequency of irrigation, the interval between two irrigations decreases in a given period, while with lower frequency the interval between two irrigations increases. The term, interval of irrigation indicates the time gap, usually expressed in days, between two subsequent irrigations.

The principal objectives of irrigation water management are to make the most effective use of water coupled with higher crop yields and to prevent waste of water and to save it for further use to irrigate new areas. Losses of water in the irrigation system may occur in the conveyance systems and field channels that aggravated with inadequate knowledge and lack of practical experience of farmers. With higher frequency of irrigation, surface soil remain moist for longer periods that leading to higher evapotranspiration losses. Thus, frequency of irrigation should be as low as possible to avoid wastage of irrigation water without affecting the crop growth and final crop yield. Longer irrigation interval cuts down the number of irrigations during the growing season and ultimately decreases the labour cost for irrigation. Of course, frequent irrigations with smaller depths of water are often more conducive to higher yields than heavier irrigations at longer intervals. In principle, the interval between two irrigations should normally be the time taken by the crops to reduce the soil water from field capacity to the lowest level of optimum soil water regime.

The interval between irrigations is given by:

$$i = \frac{d}{ET_C} \quad \text{(Equation 22)}$$

$$d = p \times D \times S_a$$

Where i = Irrigation interval (days)
 d = Irrigation depth (mm)
 ET_C = Crop water use (mm/day)
 p = Allowable depletion (fraction)
 D = Root depth (m)
 S_a = Available water capacity (mm/m)

9.3.1 Factors affecting frequency of irrigation

The two main considerations namely, water need of crops and the availability of irrigation water decides the irrigation frequency. However, knowing these two factors, the frequency of irrigation is also influenced by: Climate and season, soil characteristics, crop characteristics and crop and water management practices.

Climate and season

Climate is responsible for causing variations in consumptive use rate and frequency of irrigation. High temperature, low humidity, high wind velocity, greater solar radiation in a place emphasis the need to irrigate crops more frequently as evapotranspiration takes place at a higher rate, due to greater evaporative demand of the atmosphere. This is, particularly evident in arid and semi- arid areas and during the dry season. In high temperature and during dry season the consumptive use is increased. In this case, irrigating crops very frequently is essential, since there is a greater

evapotranspiration; frequent replenishment of soil water becomes necessary to maintain the optimum growth of crops. On the other hand, with high rainfall and greater relative humidity during the rainy season reduce the water crop requirement of crops and irrigation may be applied at longer period of intervals, when there is a need to irrigate.

Soil characteristics

Water retentive capacity of a soil is considered as the most important soil factor deciding the frequency and interval of irrigation. Soil texture, soil structure, aggregates and organic matter content influence the water retentive capacity of soils. A soil with greater water retentive capacity serves as a bigger water reservoir for crops can supply water for longer duration. Consequently, frequency of irrigation is lower and interval of irrigation is longer in heavier soils and in soils with crumb structure, good organic matter content and low content of soluble salts. On the other hand, the frequency is higher in porous sandy soils with coarse texture, poor structure and low organic matter content. Depth of soil is another factor that influences the frequency of irrigation. A shallow soil cannot hold enough water to meet the crop demand for a longer period. In this case, frequent irrigations are required with smaller depth of water each time. Irrigations at longer intervals are applied to deep soils that have a greater water holding capacity.

Crop characteristics

Crops vary in their consumptive use of water, sensitivity to water stress, water extraction capacity and optimum water regime. Frequency of irrigation thus, varies with crops. A crop having higher consumptive use rate utilizes the soil water quickly and requires more frequent replenishment of soil water. Crops like vegetables require a higher level of water to be maintained in the soil need frequent irrigations than crops like wheat, barley, maize, sorghum and finger millet, which require relatively less frequent irrigations. Crop varieties that are sensitive to drought conditions require frequent irrigations as compared to tolerant varieties. Similarly, dwarf wheat varieties are usually more sensitive to water stress than the tall wheat varieties, and then frequent irrigations are required for dwarf varieties. Rooting characteristics of crops such as shallow or deep, fibrous or tapering, vertically or laterally extensive root systems decide the frequency of irrigation. When the root system is shallow and fibrous crops are not able to utilize water from deeper soil layers and are frequently irrigated with smaller depth of water to wet only the upper soil layers. Crops with deeper and extensive root system command a greater depth of soil and water reserve and require irrigations at longer interval with less frequency, but with heavier irrigations.

In areas with shallower water table reduced irrigation requirements are practicable with increased irrigation interval. Besides, the concentration and relative proportion of the root mass in different soil layers decides the water extraction capacity. Maximum quantity of water is extracted from the upper 25 % of the effective rooting depth and least in the last 25 % of soil layer. Therefore, the water extraction pattern shows that a higher frequency with smaller depth of irrigation water each time is preferable for crops with shallow root system that extract most of their water need from the upper soil layers. Irrigation frequency varies with stages of crop growth. The consumptive use rate, sensitivity to water stress and rooting characteristics of crops differ at different stages. Generally, crops at earlier stages they are delicate and need more frequent but lighter irrigations because their root systems are not deep and extensive enough to draw water from deeper soil layers. Subsequently, the consumptive use rate gradually increases and at the same time the root system also develops. Irrigations can then be applied at longer interval, as roots are able to draw water from greater volume of soils. However, when a crop approaches maturity, the demand for

water sharply declines, since there is a steep fall in consumptive use rate and the well- developed root system can also draw water from deeper layers. The irrigation water, therefore, applied at longer intervals.

Crop and water management practices

Soil water conservation practices such as mulching and crop cultural practices, like weeding and cultivation reduce the evaporation loss and conserve more soil water for crop use. Thus, there is a reduction in irrigation requirement of crops. Method of irrigation, depth of water applied each time and the water distribution efficiency influence the frequency of irrigation as well.

9.3.2 Irrigation scheduling development

This concerns the development of schedules for the distribution of the seasonal or total irrigation requirement during the growing period of the crop. In practice it represents usually a compromise between providing the optimum application of water that matched to satisfy the varying crop water requirements over the growing season and a simplified schedule, which confirms to what can actually be managed by the farmers. In general, two types of schedules are being commonly practiced. These are: fixed and flexible schedules. A fixed schedule implies a fixed quantity of water at each application /water duty/ and at a fixed frequency, or time interval. Such schedules are usually developed to cater for the peak water demands of the crop. This system does not reflect the varying water requirements of the crop and is wasteful of water in the early and late stages of crop growth and development. The excessive water applied during the early and late stages of crop growth can cause problems of water logging, salinity and leaching of soil nutrients.

The flexible schedules are more common that overcomes the problems related to fixed schedules, is to keep the water duty constant but varying the irrigation interval. In this way the delivery of water to the root zone is varied in accordance with the changing water requirement of the crop and thus, over- watering at the early and late stages of crop growth is avoided. This method is, particularly well suited to deep- rooted crops such as maize, cotton and sunflowers growing in clay or fine textured soils, which have better water holding capacity. Therefore, in Ethiopian condition, flexible schedule, which vary the irrigation interval of water application to reflect the changing water requirements of the crop, but keeping the water duty constant, is perhaps the most efficient system that can be used. However, it might be difficult for farmers to apply smaller quantities of water below 40- 50 mm without having proper field water control structures and effective rainfall should be taken into consideration. Irrigation scheduling given for a six- month maize crop growing at Sheled, Chilalo, Arsi planted in June and effective rainfall is not included in this illustration.

Planting	Harvesting									
No. Irr.	1	2	3	4	5	6	7	8		
Irr. Interval-days	21	21	21	14	14	21	21	21		
water duty-mm	85	85	85	85	85	85	85	85		
Irr. Season	J	J	A		S		O		N	

Total Irr.=680 mm
ETC = 675 mm

Fig 13: Irrigation scheduling given for a six-month maize crop (Source: MOA, ADD, March 1990, Addis Ababa)

It can be seen from the above example for maize crop grown for dry grain that the increasing crop water requirement which reaches its peak during tasseling of maize is met by decreasing the time between irrigation from 21 days /irrigation 1- 3/ to 14 days /irrigation 4 and 5/ during peak crop water demand, resuming the 21 day cycle for irrigation 6- 8. The first irrigation immediately follows planting and the last is applied around 135 days later allowing the crop to mature on the residual soil moisture. A fixed water duty is used, if 85 mm is applied to the root zone at each irrigation time. The second example is an actual one used for large-scale irrigated cotton production in the Middle Awash Valley, where the seasonal ET_c calculated from agro- ecological data at Melka Werer is 930 mm.

Pre sowing		Planting									Harvesting		
No. Irr.		1	2	3	4	5	6	7	8	9			
Irr. Interval	14	14	14	21	21	14	14	14	21	21			
duty	200	91	91	91	91	91	91	91	91	91			
Irr. Season	M	J	J		A	S	O				N		

Total Irr = 928 mm

ETC = 930 mm

Fig 14: Irrigation scheduling given for cotton grown in the Middle Awash (Source: MoA, ADD, March 1990, Addis Ababa)

The crop is planted in mid- May and a pre- planting irrigation is applied two weeks before planting. Effective rainfall is not included. In this case, a pre- planting irrigation of 200 mm of water was applied two weeks prior to planting in order to build up the moisture reservoir in the soil that is important for deep- rooted crop like cotton and germinate weed seeds for further removal by cultivator prior to sowing the cotton crop.

The irrigation schedule illustrated in the second example above is 14 days prior to planting, immediately after planting, 28 days later, then 21 days interval / Irr. No. 3 and 4/ when around 70 days from planting the irrigation interval is reduced to 14 days in order to provide the increasing water demand by the crop during peak flowering and early boll formation /No. 5, 6 and 7/, resuming a 21 day interval between the 8 and 9 irrigation. Irrigation ceased after 133 days from planting, allowing the crop to utilize residual moisture during the harvesting period. By this time the root system is well developed and the crop will have the chance to exploit a large volume of soil for moisture and nutrients absorption. The two examples just described do not take into consideration the effective rainfall (Pe). However, as many of the small- scale or micro- irrigation schemes are situated in areas, which receive over 500 mm of rainfall, this useful additional source of water needs to be integrated into the schedule. Thus, effective rainfall should in practice be included in the calculation of the irrigation schedules. In this regard, it is important to record the rainfall data in a place. We shall take as an example the case of a six- month crop of maize to be established on the rains but maturing receiving supplementary irrigation, whereas the average rainfall pattern being as follows:

Table 17. Sample calculation of irrigation scheduling by taking into consideration the effective rainfall

	June	July	Aug.	Sept.	Oct.	Nov.	
P mm	72	132	118	89	32		
ET _c (mm/month)	75	131	130	143	98	98	
mm/day	2.5	4.4	4.3	4.8	3.3	3.3	
Irrigation schedule (date)	1/6	22/6	13/7	3/8	17/8	31/8	21/9 12/10
Interval, days	21	21	21	10	10	21	21
Amount to be applied, mm	53	92	90	48	33	69	

In the example provided above it can be assumed that the first irrigation applied on the first of June was of 53 mm (21 X 2.5 mm/day), which satisfy the ET_{crop} at the root zone for the first week of June. When the crop factor kc for maize during its initial stages of growth is 0.5 (ET_{crop} = ET_o x kc = 150 x 0.5 = 75 mm or 2.5 mm/day). After the first irrigation the following rainfall recorded:

	Date				
	9/6	10/6	13/6	18/6	Total, mm
P mm	9	10	10	7	46
Pe mm = (46 x 0.7) - 10 = 22					22

The next irrigation will be rescheduled on 22 of June. For simplicity we will use the ET_{crop} for July as two thirds of water applied on the 22nd of June will be utilized by the crop during the month of July. Thus, the water duty for the second irrigation will be 21 4.4 mm/day = 92 mm, at the root zone. However, assuming that the Pe has not been lost beyond the rooting zone of the crop through deep percolation, then we subtract the amount of Pe, which has been stored in the soil from the proposed water duty for the second irrigation is, thus 70 mm (93 mm - 22 mm). Therefore, we can apply correspondingly a reduced water duty of 70 mm on the 22nd of June. Alternatively, we can delay the second irrigation by 5 days (ET_{crop} = 93/30 = 4.4 mm/day, thus 22/4.4 = 5 days). This means that the second irrigation is rescheduled for the 27th of June. However, for ease of management requirements it is more practical to keep the planned 21 days interval during the initial stages than changing the interval and therefore, apply the reduced irrigation of 70 mm.

9.4 Determination of Irrigation Scheduling for Major Irrigated Crops

In this section discussed how to determine irrigation schedules for major field crops based on the soil and plant characteristics using various irrigation scheduling methods. Irrigation scheduling is a time-consuming and complicated process. The introduction of computer programs, however, has made it easier and it is possible to schedule the irrigation water supply exactly according to the water needs of the crops. Ideally, at the beginning of the growing season, the amount of water given per irrigation application, also called the irrigation depth, is small, but given frequently. This is, due to low evapotranspiration demand of the young plants and the crop roots depths are shallow

during the early crop development stages. During the mid season, the irrigation depth should be larger, but the irrigation water should be given less frequently, due to high evapotranspiration and maximum root depth. Thus, ideally, the irrigation depth and/or the irrigation interval vary with the crop development stages.

When sprinkler and drip irrigation methods are used, it may be possible and practical to vary both the irrigation depth and interval during the growing season. However, in the case of surface irrigation methods it is not very practical to vary the irrigation depth and frequency too much. It is also very confusing for the farmers to change the schedule all the time. Therefore, it is often sufficient to estimate or roughly calculate the irrigation schedule and to fix the most suitable depth and interval over the growing season. The three simple methods to determine the irrigation schedules are briefly described hereunder. These are: plant observation method, estimation method and simple calculation method.

9.3.1 Plant observation method

The plant observation method determines “when” the plants have to be irrigated and is based on observing changes in the plant characteristics, such as changes in colour of the plants, curling of the leaves and ultimately plant wilting. The changes can often be detected only by looking at the crop as a whole rather than at the individual plants. When the crop is under water stress condition the appearance changes from vigorous growth to slow or even completely stop growing. Some crops (such as cassava) react to water stress by changing their leaf orientation: with adequate water available, the leaves are perpendicular to the sun (thus allowing optimal transpiration and production). However, when little water is available, the leaves turn away from the sun (thus, reducing the transpiration and production). However, to use the plant observation method successfully, experience is required as well as good knowledge of the local area. Another indicator of water availability is the leaf temperature. If the leaves are cool during the hot part of the day the plants do not suffer from water stress. However, if the leaves are warm, irrigation is needed. Special devices (infra-red thermometers) have been developed to measure the leaf temperature in relation to the air temperature. However, they must be calibrated for specific conditions before being used to determine the irrigation schedule.

The disadvantage of the plant observation method is that by the time the symptoms are evident, the irrigation water has already been withheld too long for most crops and yield losses are already inevitable. Therefore, it is important to note that it is not advisable to wait for the symptoms to be evident. Especially in the early stages of crop growth (the initial and crop development stages), irrigation water has to be applied before the symptoms are evident.

Another method used to determine the irrigation schedule involves soil moisture measurements in the field. When the soil moisture content has dropped to a certain critical level, irrigation water is applied. Instruments to measure the soil moisture include gypsum blocks, tensiometers and neutron probes.

9.3.2 Estimating the irrigation schedule

A table is provided to estimate irrigation schedules of field crops for various soil types and climates. However, the values obtained from the table need to be adjusted under different circumstances. A table is provided to estimate the irrigation schedule for the major field crops during the period of

peak water demand; the schedules are given for three different soil types and climates. The table is based on calculated crop water needs and an estimated root depth for each of the crops under consideration. The table assumes that with the surface irrigation method used the maximum possible net application depth is 70 mm. With respect to soil types, a distinction has been made between sand, loam, and clay, which have, respectively, low, medium and high available water content. With respect to climate, a distinction is made between three different climates (climate 1, 2 and 3).

Table 18. Irrigation scheduling based on different soil types and climates

Soil /climate	Irrigation scheduling and reference evapotranspiration
Shallow and/or sandy soil	In a sandy soil or a shallow soil (with a hard pan or impermeable layer close to the soil surface), little water can be stored; irrigation will thus have to take place frequently but little water is given per application.
Loamy soil	In a loamy soil more water can be stored than in a sandy or shallow soil. Irrigation water is applied less frequently and more water is given per application.
Clayey soil	In a clayey soil even more water can be stored than in a medium soil. Irrigation water is applied even less frequently and again more water is given per application.
Climate 1	Represents a situation where the reference crop evapotranspiration $E_{To} = 4 - 5$ mm/day.
Climate 2	Represents an $E_{To} = 6 - 7$ mm/day.
Climate 3	Represents an $E_{To} = 8 - 9$ mm/day.

An overview of indicating E_{To} values in different climatic zones is given below based on temperature regimes of different localities.

Table 19. Indicative reference crop evapotranspiration values under different climatic zones (mm/day)

Climatic zone	Mean daily temperature		
	low (less than 15°C)	medium (15-25°C)	high (more than 25°C)
Desert/arid	4 - 6	7 - 8	9 - 10
Semi-arid	4 - 5	6 - 7	8 - 9
Sub-humid	3 - 4	5 - 6	7 - 8
Humid	1 - 2	3 - 4	5 - 6

It is important to note that the irrigation schedules given in Table 20 are based on the crop water needs in the **peak period**. It is further assumed that **little** or **no rainfall** occurs during the growing season.

Examples how to use the estimation method

1. Estimate the irrigation schedule for groundnuts grown on a deep, clayey soil, in a hot and dry climate. The climatic class has to be identified and in this case the climate 3 ($E_{To} = 8-9$ mm/day), which represents a hot climate. Table 20 shows that for climate 3 the interval for groundnuts grown on a clayey soil is 6 days and the net irrigation depth is 50 mm. This means that every 6 days the groundnuts should receive a net irrigation application of 50 mm.

3. Estimate the irrigation schedule of sorghum grown on a sandy soil, in an area with a temperature range of 15-25° C during the growing season. The average temperature is medium, then the climate 2 ($E_{To} = 6-7$ mm/day); From Table 20 provided, it can be understood that with climate 2 for sorghum grown on a sandy soil, an irrigation interval of 6 days and a net irrigation depth of 40 mm.

Table 20. Estimated irrigation schedules for the major field crops during peak water use periods at different climatic zones

Climate	Shallow and /or sandy soil				Loamy soil				Clayey soil			
	Interval (days)			Net Irr. Depth (mm)	Interval (days)			Net Irr. Depth (mm)	Interval (days)			Net Irr. Depth (mm)
	1	2	3		1	2	3		1	2	3	
Banana	5	3	2	25	7	5	4	40	10	7	5	55
Barley /oats	8	6	4	40	11	8	6	55	14	10	7	70
Beans	6	4	3	30	8	6	4	40	10	7	5	50
Carrot	6	4	3	25	7	5	4	35	11	8	6	50
Citrus	8	6	4	30	11	8	6	40	11	8	6	50
Coffee	9	6	5	40	13	9	7	60	16	11	8	70
Cotton	8	6	4	40	11	8	6	55	14	10	7	70
Cucumber	10	7	5	40	15	10	8	60	17	12	9	70
Cabbage / Cauliflower	3	2	2	15	6	3	2	20	7	5	4	30
Eggplant	6	4	3	30	8	6	4	40	10	7	5	50
Linseed	8	6	4	40	11	8	6	55	14	10	7	70
Fruit trees	9	6	5	40	13	9	7	60	16	11	8	70
Small grains	8	6	4	40	11	8	6	55	14	10	7	70
Grapes	11	8	6	40	15	11	8	55	19	13	10	70
Groundnuts	6	4	3	25	7	5	4	35	11	8	6	50
Lentils	6	4	3	30	8	6	4	40	10	7	5	50
Lettuce	3	2	2	15	6	3	2	20	7	5	4	30
Maize	8	6	4	40	11	8	6	55	14	10	7	70
Melons	9	6	5	40	13	9	7	60	16	11	8	70
Onions	3	2	2	15	6	3	2	20	7	5	4	30
Peas	6	4	3	30	8	6	4	40	10	7	5	50
Peppers	6	4	3	25	7	5	4	35	11	8	6	50
Potato	6	4	3	30	8	6	4	40	10	7	5	50
Safflower	8	6	4	40	11	8	6	55	14	10	7	70
Sorghum	8	6	4	40	11	8	6	55	14	10	7	70
Soybeans	8	6	4	40	11	8	6	55	14	10	7	70
Sugarcane	7	5	4	40	10	7	5	55	13	9	7	70
Sunflower	8	6	4	40	11	8	6	55	14	10	7	70
Tea	9	6	5	40	13	9	7	60	16	11	8	70
Tobacco	6	4	3	30	8	6	4	40	10	7	5	50
Wheat	8	6	4	40	11	8	6	55	14	10	7	70

Source: Irrigation water management: Irrigation scheduling, FAO, 1989 Rome (with slight modification)

Adjusting the irrigation schedule

a) Adjustments for the non-peak periods

The irrigation schedule, which is obtained using Table 20, is valid for the peak period; in other words, for the mid-season stage of the crop. During the **early growth stages**, when the plants are small, the crop water need is less than during the mid-season stage. Therefore, it may be possible to irrigate during the early stages of crop growth, with the same frequency as during the mid-season, but with smaller irrigation applications. It is risky to give the same irrigation application as during the mid-season, but less frequently; the young plants may suffer from water shortage as their roots are not able to take up water from the lower layers of the root zone. Dry harvested crops or crops which are allowed to die before harvest need less water during the late season stage than during the mid-season stage (the peak period). During the **late season stage**, the roots of the crops are fully developed and therefore the same amount of water can be stored in the root zone as during the mid-season stage. It is thus, possible to irrigate during the late season stage less frequently but with the same irrigation depth as during the peak period. Therefore, it may be feasible to irrigate the crop with smaller applications during the early development and late season stages than during the peak period and save the water for this critical growth stage.

When adjusting the irrigation schedule for the non-peak periods, it should always be kept in mind that the irrigation schedules must be simple, in particular in surface irrigation schemes where many farmers are involved. It will often be necessary to discuss with the farmers, before implementing the irrigation schedule, the various alternatives and come to an agreement which best satisfies all parties involved.

b) Adjustment for climates with considerable rainfall during the growing season

The schedules obtained from Table 20 are based on the assumption that little or no rainfall occurs during the growing season. If the contribution from the rainfall is considerable during the growing season, the schedules need to be adjusted: usually by making the interval longer. It may also be possible to reduce the net irrigation depth. It is difficult to estimate to which values the interval and the irrigation depth should be adjusted. It is therefore suggested to use the simple calculation method described hereunder, instead of the estimation method. Alternatively it is also possible to adjust the irrigation schedule to the actual rainfall in the case of significant rainfall during the growing season.

c) Adjustment for local irrigation practices or irrigation method used

The schedules obtained from Table 20 are based on the assumption that little or no rainfall occurs during the growing season. If the contribution from the rainfall is considerable during the growing season, the schedules need to be adjusted: usually by making the interval longer. It may also be possible to reduce the net irrigation depth. It is difficult to estimate to which values the interval and the irrigation depth should be adjusted. It is therefore suggested to use the simple calculation method described hereunder, instead of the estimation method. Alternatively it is also possible to adjust the irrigation schedule to the actual rainfall in the case of significant rainfall during the growing season.

d) Adjustment for shallow soils

A soil which is shallow can only store a little water, even if the soil is clayey. For shallow soils - sandy, loamy or clayey - the column "shallow and/or sandy soil" of Table 18 should be used and determine the irrigation schedule of the particular area.

e) Adjustment for salt-affected soils

In the case of irrigating salt-affected soils, special attention needs to be given to the determination of the irrigation schedule. In salt-affected soils increasing the frequency of irrigation might be the solution in order to avoid water stress and simultaneously leach down the salt beyond the active rooting depth in order to avoid salt damage to crops.

9.3.3 Simple calculation method

The simple calculation method to determine the irrigation schedule is based on the estimated depth (in mm) of the irrigation applications, and the calculated irrigation water need of the crop over the growing season. Unlike the estimation method discussed above, the simple calculation method is based on calculated irrigation water needs. Thus, the influence of the climate, i.e. temperature and rainfall, is more accurately taken into account. The result of the simple calculation method will therefore, be more accurate than the result of the estimation method.

The simple calculation method to determine the irrigation schedule involves the following steps that are explained in detail below:

- Step 1: Estimate the net and gross irrigation depth (d) in mm,
- Step 2: Calculate the irrigation water need (IN) in mm, over the total growing season,
- Step 3: Calculate the number of irrigation applications over the total growing season,
- Step 4: Calculate the irrigation interval in days.

Step 1: Estimate the net and gross irrigation depth (d) in mm

The net irrigation depth is best determined locally by checking how much water is given per irrigation application with the local irrigation method and practice. If no local data are easily available, Table 51 can be used to estimate the net irrigation depth (d net), in mm. As can be seen from the table, the net irrigation depth is assumed to depend only on the root depth of the crop and on the soil type. It must be noted that the net irrigation depth (d net) values in the table are approximate values only. Also the root depth is best determined locally. If no data are available, Table 51 can be used which gives an indication of the root depth of the major field crops. Not all water which is applied to the field can indeed be used by the plants. Part of the water is lost through deep percolation and runoff. To reflect this water loss, the field application efficiency (ea) is used. The gross irrigation depth (d gross), in mm, takes into account the water loss during the irrigation application and is determined using the following formula:

$$d_{gross} = \frac{100 \times d_{net}}{e_a} \quad (\text{Equation 23})$$

Where: d_{gross} = gross irrigation depth (mm)

d_{net} = net irrigation depth (mm)

e_a = field application efficiency (%).

If reliable local data are available on the field application efficiency, these should be used. If such data are not available, the field application efficiency of 60, 75 and 90 % for surface irrigation, sprinkler irrigation and drip can be used respectively (Table 14). If, for example, tomatoes are grown on a loamy soil, Table 51 shows that the estimated net irrigation depth is 40 mm. If furrow irrigation is used, the field application efficiency is 60 % and the gross irrigation depth is determined as follows:

$$d_{gross} = \frac{100 \times 40}{0.60} = 67 \text{ mm} \approx 65 \text{ mm}$$

Step 2: Calculate the irrigation water need (IN) over the total growing season

Assume that the irrigation water needs (in mm/month) for tomatoes, planted 1 February and harvested 30 June, are 67, 110, 166, 195 and 180 respectively. The irrigation water need of tomatoes for the total growing season is thus, 718 mm ($67 + 110 + 166 + 195 + 180 = 718$ mm). This means that over the total growing season a net water layer of 718 mm has to be brought onto the field. If no data on irrigation water needs are available, the estimation method can be used.

Step 3: Calculate the number of irrigation applications over the total growing season

The number of irrigation applications over the total growing season can be obtained by dividing the irrigation water need over the growing season (Step 2) by the net irrigation depth per application (Step 1). If the net depth of each irrigation application is 40 mm ($d_{net} = 40$ mm; Step 1), and the irrigation water need over the growing season is 718 mm (Step 2), then a total of ($718/40 =$) 18 applications are required.

Step 4: Calculate the irrigation interval (INT) in days

Thus, a total of 18 applications are required. The total growing season for tomatoes is 5 months (Feb-June = 150 days). Eighteen applications in 150 days corresponds to one application every $150/18 = 8.3$ days. In other words, the interval between two irrigation applications is 8 days. To be on the safe side, the interval is always rounded off to the lower whole figure: for example 7.6 days to 7 days; 3.2 days becomes 3 days.

Adjusting the simple calculation method for the peak period

When using the simple calculation method to determine the irrigation schedule, it is advisable to ensure that the crop does not suffer, due to water shortage in the months of peak irrigation water need. For instance, in the above example the interval is 8 days, while the net irrigation depth is 40 mm. Thus, every 30 days (or each month): $30/8 \times 40$ mm = 150 mm water is applied. The amount of water given during each month (d_{net}) should be compared with the amount of irrigation water needed during that month (IN). The result is shown below. The "IN" values represent the irrigation

water needs, while the “d net” values represent the amount of water applied. The “d net - IN” values show whether too much or too little water has been applied:

	Feb	Mar	Apr	May	June	Total
IN (mm/month)	87	110	166	195	180	718
d net (mm/month)	150	150	150	150	150	750
d net - IN (mm/month)	+83	+40	-16	-45	-30	+32

The total net amount of irrigation water applied (750 mm) is more than sufficient to cover the total irrigation water need (718 mm). However, in February and March too much water has been applied, while in April, May and June, too little water has been applied. Therefore, care should be taken with under-irrigation (too little irrigation) in the peak period as this period normally coincides with the growth stages of the crops that are most sensitive to water shortages. To overcome the risk of water shortages in the peak months, it is possible to refine the simple calculation method by looking only at the months of peak irrigation water need and basing the determination of the interval on the peak period only. In the example given above for tomatoes, this means looking at the months of April, May and June, the monthly water needs of tomato are 166, 195 and 180, which is summing up 541 mm, while the net irrigation depth is 40 mm. Thus, the number of applications needed are 14 applications ($541/40 = 13.5$ rounded to 14). Fourteen applications in 90 days means one application every 6.4 (rounded 6) days. Therefore, the calculated irrigation schedule for the tomato would be: d net = 40 mm; d gross = 65 mm and interval = 6 days. Over the total growing period of 150 days, this means $150/6 = 25$ applications, each 40 mm net and thus, in total $25 \times 40 = 1000$ mm. The overall result of adjusting the irrigation schedule to the months of peak irrigation water demand is therefore, 200 mm per month. This way of determining the irrigation schedule avoids water shortages in the month of peak water needs but on the other hand also results in a higher seasonal irrigation water application.

	Feb	Mar	Apr	May	June	Total
IN (mm/month)	87	110	166	195	180	718
d net (mm/month)	200	200	200	200	200	1000
d net - IN (mm/month)	+113	+90	+34	+5	+20	+282

10. MEASUREMENT OF IRRIGATION WATER

Module 9

Objectives:

After reading this chapter, participants will be able to:

- describe the main simplified methods of irrigation water measurement;
- better understand and acquired skills on practical methods of water measurement

Water is the most valuable asset of irrigated agriculture. An accurate measurement of irrigation water permits more systematic and wise use of this valuable natural resource. Measurement of irrigation water is essential to ensure application of the exact quantity of water need by the crop by reducing excess application of water that might cause water logging problem and create poor aeration. In addition, measurement of irrigation water allows knowing of the exact amount of available water and distributes this available resource to users on equitable basis. Accuracy in irrigation water measurement is therefore, of prime importance in the operation of any water distribution system.

10.1 Methods of Water Measurements

Different methods are applied to measure irrigation water at rest and in motion. However, considering the importance of the methods of water measurements only the major ones are discussed in this manual.

10.1.1 Units of water measurement

Different units are used to measure irrigation water at rest and while flowing. The units used to measure water at rest are units of volume such as liter, cubic meter and hectare-centimeter. The units of measurement of water in motion are expressed in unit of time rate of flow such as liters per second, liters per hour, cubic meters per second, hectare-centimeters per hour, and hectare-meters per day.

10.1.2 Measurement of water at rest

Water in ponds, tanks and reservoirs are measured by volumetric method that involves determination of the volume by the area (Length x Width or Breadth) occupied by water multiplied by the average depth of water. The volume of water then can be calculated using the following formula:

$$V = (L \times B) \times d \quad \text{(Equation 24)}$$

Where V = volume of water

L = Length

B = Breadth

d = Average depth of water

10.1.3 Measurement of water flow

Measurement of water in motion that is, flowing in rivers, canals, pipe lines, and field channels can be carried out using different methods. These methods are: (1) Volumetric method (2) Velocity-area method /float method, current meter method, pipe method/ (3) Volume metering methods (4) Methods of using measuring structures /orifices, weirs, meter gates and flumes/

Here under are only discussed methods of measurement of water using the volumetric method for the water at rest and velocity- area method used to measure water in flow for example in an open channel.

a) Volumetric method

The volumetric method usually used to measure small discharges diverted to crop fields. It can be used to calculate discharges from pumps or other water lifts commonly used by the farmers in villages. The flow is determined by noting the time for the reservoir to fill to a certain depth, or for the water surface to rise from one level to another. The method is very simple and does not require a sophisticated equipment, arrangement or specialized skill while measuring water. The procedure is simply to flow water in a container of known volume for a measured period of time. An ordinary bucket or barrel is used as a container as shown in fig. 15. The time required to full the container is recorded in seconds with a stop watch.

$$\text{Discharge rate, liter/second} = \frac{\text{Volume of container, liters}}{\text{Time required for filling the container, seconds}}$$

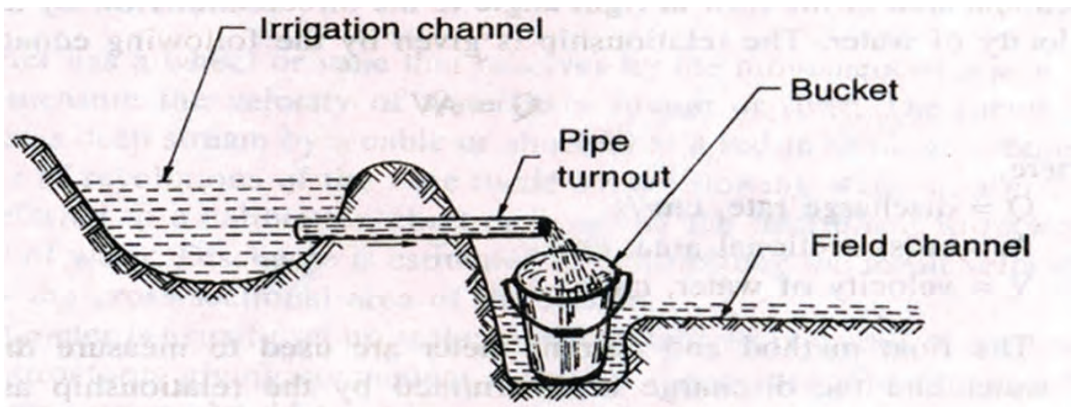

Fig. 15. Volumetric method of flow measurement of in the field channel (Source: D.K., Majumdar, New Delhi, 2000).

b) Velocity - area method

The method involves the measurement of velocity of water flow passing a point in an open channel or a pipe. The flow rate is determined by multiplying the cross- sectional area of the flow section at right angle to the direction of flow by the average velocity of water.

$$Q = A \times V \quad \text{whereas} \quad A = w \times d \quad \text{(Equation 25)}$$

Where Q = discharge rate, m^3/second

A = area of cross- section of channel or pipe, m^2

V = velocity of flow, m/second .

w = Average width of channel

d = average depth of water

The flow rate of a river or of a channel is the volume of water discharged through this river, or this canal within a given period of time. Related to irrigation, the volume of water is usually expressed in liters (l) or cubic meters (m^3) and the time in second (s), on hour (h).

Example 8:

For better understanding, consider the case of water flowing in a channel 1.5 m wide and 0.5 m deep (with a cross- sectional area of 0.75 m^2) at 1.0 m/s. The volume flowing in each second or the discharge is equal to the canal area 0.75 m^2 multiplied by the average velocity, i.e. $0.75 \times 1.0 = 0.75 \text{ m}^3/\text{s}$. The discharge required to irrigate basins, border, and furrow is usually called the stream size. This is measured in liters per second. In borders the term unit stream is used. This is the discharge for each meters width of the border.

There are a number of methods for measuring the velocity of water flowing in a ditch or channel. The simplest method that required minimum equipment is the floating method, which gives a reasonably accurate estimate of water flow. All that required is a measuring tape, a watch or clock with the facility to measure seconds, a floating object- ideally a table tennis ball or a small piece of light weighted wood or a long necked bottle half filled with water and two wooden marker pegs. The discharge rate of flow in an open channel is determined by multiplying the cross- sectional area by the velocity of water. Procedures for measuring water discharge in an open channel: (1) In the open channel select a place which is straight and has an equal width; (2) Measure the average width of the ditch or channel; (3) Measure the average depth of the channel; (4) Determine the cross- sectional area of the channel by multiplying the average width with an average depth of the channel ($A = w \times d$, in m^2); (5) Lastly the velocity of the water flow in the channel should be measured; (6) Finally, the water discharge in the open channel can be calculated.

10.2 Procedures of Water Measurement in an Open Channel

(1) Measuring of width or average width of an open channel

In order to measure the width of a channel the following procedures should be followed: (1) Select straight canal view and stretch a string from one side of the channel to the other side; (2) Put marks on the string to indicate the exact water surface on both sides of the channel; (3) Then measure the distance between the two marks and this is the width of the channel. If the field channel does not have equal width along the straight line selected it is better to take measurements at more places and take the average width of the channel (fig. 16). In this case,

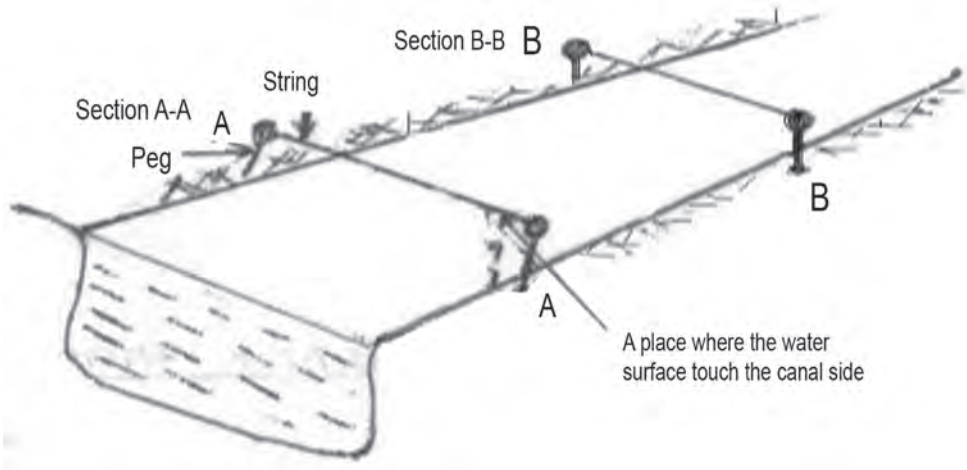

Fig. 16. Schematic illustration how to measure width of a canal

(2) Measuring the average depth of water

In order to measure the average depth of water it is possible to use bamboo or a piece of wood circular at the base. The wooden piece should have a thickness of 3- 8 cm in order to resist the pressure of the water and delineated on it in meter and centimeter. The height preferably is more than one meter. On the measuring stick numeration should be written starting from 0 following bottom to up approach and zero should be marked at the flat bottom of the stick (fig 17). The measuring can be done on the same area where the width is measured and measurements are taken at 30 cm interval. The average depth can be determined by dividing the sum of all the measured depths by the number of measurements taken (fig 18).

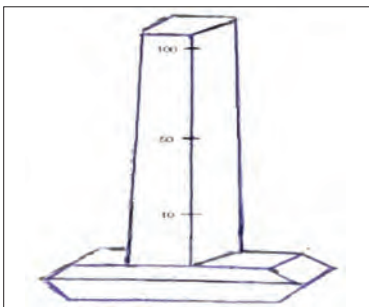

Fig. 17. A wooden stick for measuring of depth

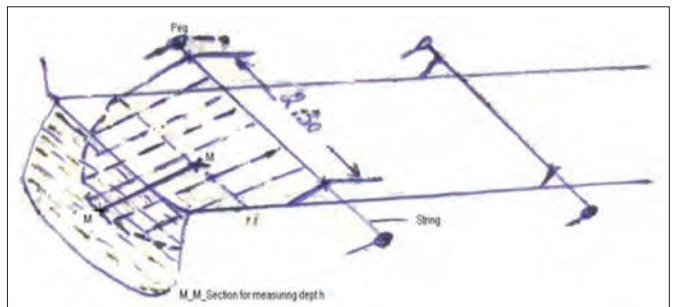

Fig. 18. Schematic illustration showing measuring of depth

Sample data for measuring depth:

Number of tests	1	2	3	4	5	6	7	Average
Depth, m	0.30	0.40	0.51	0.52	0.51	0.50	0.35	$3.09 / 7 = 0.44$

Number of trials for measuring depth are 7 and an average depth of an open channel is therefore, equal to 0.44 m (Total depths measured divided by the number of trials; $3.09/7 = 0.44$ m).

(3) Measuring the cross- sectional area

The cross- sectional area is calculated by multiplying the width by the average depth of the canal. To do this first it is recommended summing up of all the partitions subdivided to measure the depths at certain intervals and then multiply the result with the average depth.

Cross- sectional area, $m^2 = \text{average width, m} \times \text{average depth, m}$ (Equation 26)

$$1.02 \text{ m}^2 = 2.30 \text{ m} \times 0.44 \text{ m} = 1.012 \text{ m}^2$$

(4) Measuring of the water velocity in an open channel

In order to measure the velocity of water the following procedures should be followed:

- Using the tape measure or mark out a 10 m run along the bank of the ditch /water channel/ demarcating the beginning and the end of the length using the two wooden pegs, the strip should be parallel to the flowing of water;
- Mark out a point on the upstream side of the channel at 5 m distance where width measurement is taken and name the section A- A and place peg 1;
- Stretch another string on the downstream side at 5 m distance from the upstream point and mark peg 2 and name the section B- B;;
- Then stretch a third string about 10 m away from the second peg to the downstream side and mark peg 3 and name the section C- C;
- The water velocity in the channel could be measured using a floating object;
- The floating object could be a long necked bottle half filled with water or any other floating object like a tennis table ball;
- Put the floating object on the upstream side at 5 m from the second peg at a section A- A and check whether the floating object is floating or not;
- Place the floating object in the middle of the water flow just at section A- A and note the first time reading when the float is passing the second peg and record the time when the object passes the second peg and calculate the total time taken from section B- B and C- C;
- Repeat the test at least three five times and record the times all the time in order to be more accurate in estimating and obtained an average velocity.
- Dividing the distance from section B- B to section C- C by the time taken for the float object to pass from section B- B and A- A gives the actual speed of the water; Average speed of water, m/s is equal to distance from section B- B to section C- C (m) divided by the average time taken by the float object (s).
- Finally, knowing the cross- sectional area of the channel and the average velocity of the water in the channel, the discharge of the water in the open channel could be calculated by multiplying the cross- sectional area by the velocity of the water.

Example 9

Test No.	Time in second	Velocity of water in m/s
1	20	0.50
2	21	0.47
3	20	0.50
4	22	0.45
5	20	0.50
Average	20.6	0.48

At the end of the test the results should be added and divided by the total number of tests. Therefore, an average velocity is $10/20.6 = 0.48$ m/s. Therefore, the discharge is 0.49 m³/s (Discharge, l/s = $A \times V = 1.02$ m² x 0.48 m/s = 0.49 m³/s).

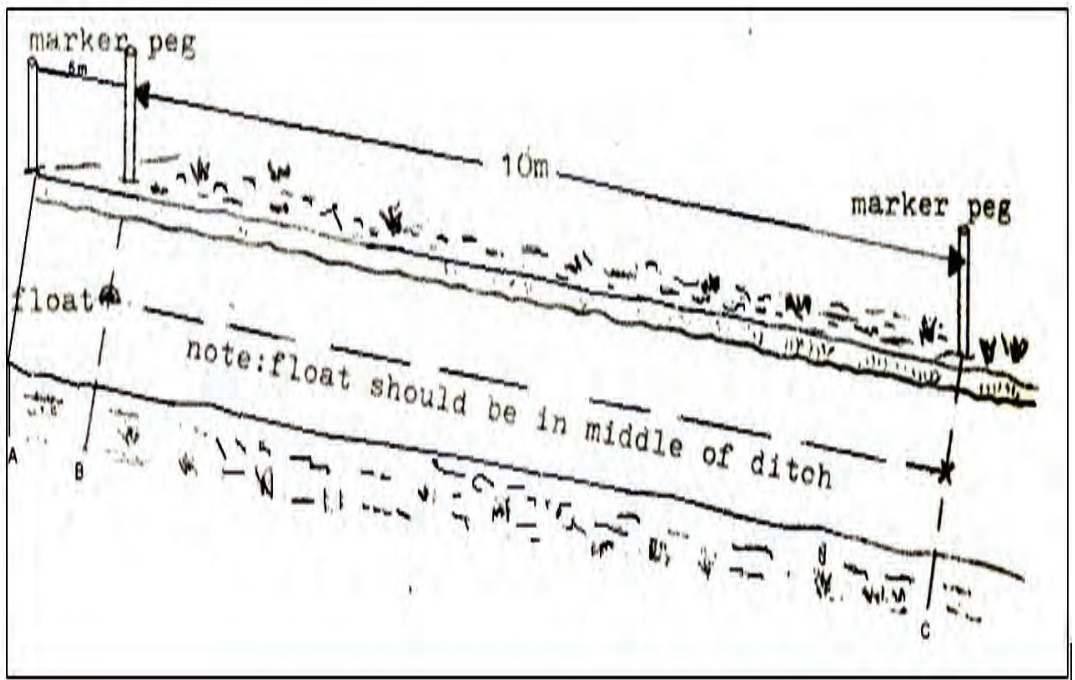

Fig. 19. Diagram illustrates the float method of measuring the velocity of water flowing in a ditch or an open channel

11. IRRIGATION WATER QUALITY

Module 10

Objectives:

After reading this chapter, participants will be able to:

- describe the major sources, types of salt affected soils and problems of salinity
- better understand and acquired skills on methods of overcoming salinity problems

Quality of irrigation water is essential to maintain both the soil and crop productivities at high levels. The most essential prerequisite for quality irrigation water is that it should be safe for use to crops and should not damage soils as well. Irrigated agriculture in Ethiopia is, however, dependent on adequate water supply of usable quality. The irrigation schemes being developed in the highlands where there is a reasonable amount of rainfall and adequate natural drainage the possible development of salinity related problems are unlikely to manifest themselves. However, the inadequate rainfall in arid and semi- arid areas of the country, sufficient water is not penetrating through the soil profiles coupled with high degree of evapotranspiration will cause the accumulation of soluble salts on the soil surface, particularly on the upper layers of soil which are damaging the crop growth and reduce yields. In fact water quality was not a great concern in the country until recently, because good quality of irrigation water supply has been plentiful and readily available as it is explained above. However, this situation is being changing, particularly in irrigated areas of the lowlands, which are experiencing inadequate rainfall and accumulation of salts is possible in the upper soil layer.

In Ethiopia, approximately 11 million ha are salt affected soils (FAO, 1988). These salt affected soils are mainly concentrated in the Rift Valley, Wabe Shebelle River Basins and other different lowlands and valley bottoms, where experiencing inadequate rainfall. So that these indications are alarming to pay special attention for proper water management practices in order to avoid salt build up in irrigated fields and reclaim the salt affected areas back to their productivity level through proper application of recommended corrective measures. Therefore, water quality is an important factor that should be considered in planning or deciding the irrigation practice. In many arid and even in semi- arid areas, where rainfall is very limited water quality is taken as a prime consideration in deciding what types of crops to be grown, the amount of water to be used both for the crop and leaching and also the type of irrigation system to be used.

Water quality refers to the characteristics of a water supply that will influence its suitability for specific use. Usually, quality is defined by certain physical, chemical and biological characteristics. However, in irrigation water more emphasis is given to physical and chemical characteristics of the water. Irrigation water drawn from different sources, surface or ground water contains variable quantities of salts, silts and other suspended materials. The quality and quantity of salts and silts present in the water depend on the nature of water sources, the soils and underground strata over which the water flows. River waters usually carry silts in suspension and salts in solution,

whereas well water contains only dissolved salts in solution and sometimes silts in suspension. Water quality primarily refers to the content of various salts in the water, notably bicarbonates, chlorides, sulphates and particularly, the element sodium. Other impurities such as silt in fact are considered beneficial. Water used for irrigation can vary greatly in quality depending upon type and quantity of dissolved salts. Salts may present in irrigation water in relatively small but significant amounts. Thus, the suitability of water for irrigation is determined not only by the total amount of salt present but also by the type of salts. Various soils and cropping problems develop as the total salt content increases and special management practices may be required to maintain acceptable crop yields. Water quality for use is judged on the potential severity of problems that can be expected to develop during long- term use.

11.1 Sources of Salinity

The main sources of salinity are:

- Salts in irrigation water, primarily through weathering of rocks from watershed or catchment areas that contain alkaline salts in their soils and dissolved soil minerals that further drained out to rivers and seas where there is adequate rainfall, whereas in arid and semi- arid areas these salts accumulate in the soil profile at lower layers. When the soil water from the upper soil layers evaporates, salts accumulate in the upper layers and can cause damage to growing crops;
- Seepage and back- water flow to rivers from already salinized irrigation schemes;
- Deposition of salts on soil surface from high water table level, due to inadequate drainage system;
- Injudicious use of saline water for irrigation or poor water management practices.

Thus, water quality must be given prime consideration in using water for irrigation purpose. The amount of soluble salts in water can be determined by various methods; however, the simplest is to measure its electrical conductivity, which is done using a simple meter, which measures the electrical resistance of the sample water. Values are quoted in millimhos/cm ($EC \times 10^3$) or micromhos/cm ($EC \times 10^6$) or ds^m- deci siemens/meter is the new unit and is equivalent to 1 millimhos/cm.

11.2 Types of Salt Affected Soils

Based on their chemical properties and ease of reclamation, salt affected soils are classified into three groups, namely; saline, sodic and saline- sodic according to the United States Salinity Laboratory classification. Basically, three criteria are used: the electrical conductivity of the saturated soil paste (EC_e) in mmhos/m at 25 °C, the pH of the soil and the percentage of exchangeable sodium.

The exchangeable sodium percentage (ESP) used as a classification criteria is computed as:

$$ESP = \frac{Na}{CEC} \times 100$$

Where: ESP = exchangeable sodium percentage

CEC = cation exchange capacity = Mg + Na + K + Al + H, concentrations of all constituents are expressed in meq/100 g soil.

A threshold level of 4 mmhos/cm was adopted as at this concentration of salts, the yields of most crops are reduced. A pH of 8.5 was chosen as at levels above this is a number of plant nutrients become unavailable and finally an exchangeable sodium percentage of 15 was used to differentiate between the three main kinds of salt affected soils, as above this level, the growth and of most crops is affected.

Table 21. Summary of classification of salt affected soils

Salt affected soil types	Electrical conductivity of saturated extracts mmhos/cm	Soil pH	ESP	Other characteristics
Saline	> 4.0	< 8.5	< 15	Main anions are Cl, Sulphates, little bicarbonate and physical condition satisfactory
Sodic	< 4.0	> 8.5	> 15	Main anions are carbonates with sodium and physical condition very poor
Saline sodic	> 4.0	< 8.5	> 15	Main anions are carbonates with some chlorides and sulphates. Physical condition outwardly satisfactory but inwardly poor
Non- saline and non- sodic	< 4.0	neutral	< 15	

Source: Adopted from Irrigation Agronomy Manual. ADD, August 1990, Addis Ababa, with slight modification

Saline soils: Saline soils are soils where soluble salts are present in the soil solution in greater quantity that is enough to interfere with the growth and productivity of most crop plants. They are characterized by an $EC_e > 4$ mmhos/cm (dS/m), $ESP < 15$ and a pH reading < 8.5 . Saline soils are usually recognized with the presence of white crusts of salts on the surface soil during dry weather formed through the loss of water of crystallization. In saline soils the principal anions are chloride, sulfate, small amounts of bicarbonate, and occasionally some nitrate.

Sodic soils: Sodic soils contain excessive quantities of exchangeable sodium in their exchange complex as to interfere with the growth and production of most crop plants. These soils are characterized by an $ESP > 15$, and $EC_e < 4$ mmhos/cm and a pH reading > 8.5 or usually ranging between 8.5 and 10. Sodic soils are typically poorly- structured, characterized by the presence of dispersed colloidal clays and organic matter in the top soil. The presence of dispersed colloidal clays and organic matter on the surface of the soil attributed to swelling of clay and organic colloidal physically damages soil structure that leads to permeability and drainage problems, low infiltration rates, poor aeration, surface crusting and difficult to till and for plant roots to penetrate through. In addition to deterioration of soil physical properties, the presence of Na can exert toxic effects on plants.

Saline sodic soils: Saline sodic soils contain soluble salts and exchangeable Na in quantities high enough to adversely affect the growth and productivity of most crop plants. These soils are characterized by $EC_e > 4$ mmhos/cm, an $ESP > 15$, and a pH reading < 8.5 . As the name indicates that saline sodic soils have the problem of both salinity and sodicity. Therefore, saline sodic soils posses the appearance of and properties of both saline and sodic soils and characterized by hard subsoils and more or less impermeable to water. In saline sodic soils the dispersing effect of the

exchangeable Na may counterbalance by the coagulating effect of the soluble salts present in excessive concentrations in the soil. Thus, unlike sodic soils saline sodic soils are typically well-structured and permeable.

11.3 Salinity Problems

Soluble salts are salts in the soil which readily dissolve and become concentrated in the soil surrounding the root-zone to cause salt affected soils. The development of salt affected soils and the problems associated with them are most pronounced in arid and semi-arid regions, which are resulted, due to high evaporation effect and inadequate annual rainfall that does not facilitate the natural leaching of salts from the active root-zone soils down to soil depths not reachable by crop roots and that can't cause further harm to crop plants.

Salinity hazard refers to the extent of the concentration of total dissolved salts in the irrigation water. The total soluble salt content of irrigation waters is measured as total dissolved salts (TDS) or electrical conductivity (EC). Soil salinity is becoming a concern when water or reclaimed water or liquid wastes containing excessive dissolved salts are applied to the soil. Irrigation water contains a mixture of naturally occurring salts. Soils irrigated with this water will contain a similar mix but usually at a higher concentration than in the applied water. The extent to which the salts accumulated in the soil will depend upon the irrigation water quality, irrigation management practices and the adequacy of drainage. If we are using water that contains some salts dissolved in it, salts are added to the soil with irrigation water and can be accumulated on the rooting depth to damaging concentrations. The crop can use much of the applied water from the soil to meet its evapotranspiration demand but leaves most of the salt behind. The build up of salts in irrigated field will cause a serious problem and rendering the soil unproductive for crop production purpose. Therefore, these accumulated salts must be leached down below the rooting depth using excess water before the salt concentration affects crop yield and other corrective measures should be taken to alleviate salt related problems.

Table 22. Classification of irrigation waters and their suitability to crops

Salinity class	Salinity hazard	EC, $\mu\text{mhos/cm}$	Suitability of irrigation water to crops
C1	Low	100- 250	Low salinity water, can be used for most crops and on most soils with unlikely develop salinity
C2	Medium	250- 750	Medium salinity water, can be used to crops which have moderately tolerant to salinity assuming that the soil has better infiltration capacity and dissolved salts are leached down beyond the root zone
C3	High	750- 2250	High salinity water, can be used for growing of salt tolerant crops strictly with adequate drainage and applied special management for salinity control and the soil must be permeable for better infiltration
C4	Very high	> 2250	Very high salinity water, not suitable for irrigation under ordinary management, but it can be used under permeable soil conditions with adequate drainage to provide considerable leaching of salts and by selecting very highly salt tolerant crops like barley, rice

Source: Agricultural development and irrigation management guideline, former MoA, ADD, Dec. 1985, Addis Ababa.

11.4 Salinity Effects on Crops

The primary objective of irrigation is to provide a crop with the required amount of water at the right time when the crop needs water and avoiding yield losses caused by extended periods of water stress, particularly during sensitive stages of crop growth to water deficit. However, as a result of increased concentrations of salts, due to repeated irrigation with poor quality of irrigation water and applying of poor irrigation water management practices can affect the growth of plants and alteration of soil physical properties. The salt concentrations can affect the growth of crop plants by primarily increasing the osmotic pressure of the soil water, thereby reducing the plants ability to take up water through their roots. This is often manifested by stunted plant growth and very often resulted in wilting of the leaves. In the case of sodium, high exchangeable sodium percentage (ESP) can affect the plant by causing a dispersion of clay particles and thus, a deterioration of soil structure as result of dispersion of clay particles, which can be moved down and create lower permeability to water. This, of course, will affect the water uptake of the plant. Sodium can also reduce the absorption and availability to plants of other nutritionally important cations such as Ca^{++} , Mg^{++} , K^+ , Cu^{++} , Zn^{++} , Mn^{++} , etc, which are normally held on particles of clay and humus.

In irrigated fields, cations present in irrigation water as soluble salt, take part in an exchange, which takes place in between sodium ion in the irrigation water and calcium ion in the exchange complex of the soil.



Sodium is the most problematical element and badly salinized soils have a high exchangeable sodium percentage (ESP). The problem arises when calcium cations which are normally hold on particles of clay are replaced by sodium cations as indicated in the illustration presented above. Excessive exchangeable sodium in soils causes swelling and dispersion of soil colloidal particles resulting in poor water movement and infiltration, air movement and root penetration problems. Plants grown on saline salt affected soils usually have no distinctive symptoms on their foliage parts, but generally stunted in growth, have smaller but thicker leaves than the normal plant, have darker green and curled leaves and stunted fruit development. The general effect of excessive salts on crops is reducing crop growth and consequently resulted in reduced yield. Moreover, during germination and seedling stages most crops are sensitive to salts.

In general, the adverse effects of excessive concentrations of soluble salts and exchangeable sodium of salt affected soils on plant growth and soil properties are summarized as follows:

- The salt concentrations in the soil primarily increased the osmotic pressure of the soil water, and thereby reducing the plants ability to take up water through their roots;
- Soluble salts increased the concentrations of certain ions that have characteristic toxic effects on plant physiological processes;
- Presence of excessive accumulations of specific ions and/or salts in the soil creates nutritional disorders of essential nutrients;

- Excessive exchangeable sodium in the soil causes alteration of soil physical properties by swelling and dispersion of soil colloidal particles and finally resulting in poor water movement and infiltration, aeration root penetration and seedling emergence problems;
- The salt affected soils can also adversely affect the population, composition and activity of beneficial micro-organisms either through osmotic effects or toxicity of certain ions of such soils.

Crop plants vary in their sensitivity to salinity; crops like beans, maize, carrot, onion, lettuce are more sensitive than others, notably, barley, cotton, and sugar beet, which have a high tolerance to salt. The relative salt tolerance nature of crops to salinity is shown in Table 23 below

Table 23. Relative salt tolerance of crops in decreasing order

Tolerant	Semi- tolerant		Sensitive
Barley	Oats	Potato	Field beans
Sugar beet	Rice	Carrot	Peas
Tobacco	Sorghum	Onion	Green beans
Cotton	Maize	Pea	Apple
Wheat	Sunflower	Cucumber	Orange
Beet root	Sesame	Grape	
Asparagus	Linseed	Guava	
Spinach	Lucerne	Mango	
Coconut	Tomato	Banana	
	Cabbage	Sugar cane	
	Cauliflower	Strawberry	
	Lettuce		

Source: FAO, 1989. Water quality for agriculture. FAO Irrigation and Drainage paper No. 29 Revised

11.5 Methods of Overcoming Salinity Problems

The procedure of the reclamation and management of salt affected soils depends upon the type of the problem under consideration, its causes and other factors influencing its management and reclamation activities. Thus, prior to initiation of taking any control measures in order to reclaim salt affected soils the following points require, due attention: (1) The type of salt affected soils should be determined (saline, saline- sodic and sodic); (2) Causes of soil salinity; (3) Degree of salinity or severity of the problem; (4) Physical properties and mineralogical composition of the soil (soil texture, dominant type of clay mineral, hydraulic conductivity, CaCO_3 and CaSO_4 contents, the expected change in the soil physical properties after leaching or any other amendments); (5) The desired extent of leaching or removal of salts and the rate of replacement of exchangeable sodium depending on soil texture, crops to be grown, quality and availability of water both for leaching of salts and irrigation.

In general, the presence of adequate drainage systems is a prerequisite for management and reclamation of salt affected soils. The major objective of improved management under saline conditions is to keep salinity within acceptable limits for germination, seedling establishment, and crop growth and yield while minimizing the salt loading effects of drainage. The overall management practices that aimed at controlling and/or minimizing salinity and /or sodicity problems include:

- Use of good quality irrigation water unless and otherwise the availability is limited;
- Use of proper irrigation methods;
- Proper shaping of seed beds that avoids salt accumulation in the root zone of germinating seeds;
- Timing of irrigation;
- Establishing of adequate drainage systems;
- Apply pre-planting irrigation for leaching salts;
- Selecting of crops tolerant to salinity and sodicity;

Soils will become salty if salts are allowed to accumulate. Proper irrigation management and adequate drainage are not only important measures for the improvement of salty soils, they are also essential for the prevention of salinization. These suggested control options are discussed in more details as follows.

1) Leaching

Leaching is the process of dissolving and transporting soluble salts by downward movement of water through the soil profile to reduce and control soil salinity and the accumulation of toxic ions in the surface soil. It is true that leaching is the principal method of removing salts from the active root zone beyond the rooting zone where they can do no harm to the crop plants by applying greater quantity of water than the crop water use. For carrying out this activity effectively it will be important to apply a greater quantity of irrigation water than required to satisfy the water requirements of the crop in order to leach out the excessive salts accumulated in the upper layers of soil, where most of the roots of crop plants are mainly concentrated and absorbing water and other essential soil nutrients. The most important questions that should be answered are how much water should be applied and when should be applied for leaching?

The proportion of the irrigation water that must be leached through the rooting zone in order to maintain the salinity of the soil at a specified limit is known as the leaching requirements. Indeed the leaching requirements are an integral part of the use of water for irrigated crop production. The leaching requirements can be computed using the following formula:

$$LR = \frac{EC_{iw}}{5EC_e - EC_{iw}} \quad (\text{Equation 27})$$

Where: EC_{iw} = salinity of the applied irrigation water in mmhos/cm

EC_e = average soil salinity level tolerated by the crop for specific yield potential, as measured on a soil saturation extract in mmhos/cm

Leaching fraction (LF) is a fraction of the water applied that passes through the soil profile and the magnitude of the value of LF indicates the extent of accumulation in or leaching or removal of soluble salts and toxic ions from the soil. The leaching fraction defines the amount of additional water needed to remove salts from the root zone considering the depth of effective root zone, which is affected by crop/rooting pattern, irrigation method and soil profile. The leaching fraction is computed as:

$$\text{Leaching fraction (LF)} = \frac{\text{depth of water leached beyond the rooting zone}}{\text{depth of irrigation water applied}} \quad (\text{Equation 28})$$

Although, soil salinity is not a problem for most of the irrigation schemes being developed in the highland areas of Ethiopia for reasons discussed earlier. Salt related problem is a concern in arid and semi- arid areas of the country where experiencing inadequate rainfall. However, an understanding of the requirement and methods of leaching is essential in irrigated agriculture. The knowledge can be applied effectively when the need comes or in the case of remedial action is required. Without leaching, salts accumulate in direct proportion to the salt content of the irrigation water and the depth of water applied. The concentration of salts in the soil solution results principally from the extraction of moisture from the soil by the process of evaporation and transpiration.

Leaching methods

The most effective method is achieved by ponding quite sufficient of water on the surface of the soil by the use of basins, borders or level checks, where the land is more or less flat or by using contour borders or checks where the land is sloppy. Furrows are not effective for leaching purpose. After leaching it may be necessary to apply fertilizers since nutrients can be moved down beyond the rooting zone together with the harmful salts. The efficiency of leaching depends on the amount of water applied, the uniformity of water distribution and the adequacy of drainage systems in the field. In areas where salt is a problem salt sensitive crops or low salt tolerant crops have higher leaching requirements as compared with less salt sensitive ones and require more frequent leaching.

Timing of leaching

In general, leaching is not required in areas, where there is adequate rainfall that facilitate natural leaching down of salts. But in low rainfall areas, where natural leaching is not possible, due to the inadequate nature of rainfall, leaching is a prerequisite for cultivating crops and expected promising yield. Leaching can be done at every irrigation, alternately, less frequently, such as seasonally, or at even longer- intervals, as necessary to keep salinity below the threshold that further increased salinity may reduce crop yields. According to the sensitiveness of crops to salinity it is necessary to leach once or more time during the growing period. Leaching is generally, more effective in the coolest months, since losses through evapotranspiration are minimum. In addition, a well cultivated soil will facilitate a more uniform distribution of water through the soil profile. The timing of leaching normally depends on the salt concentrations expected to exceed crop tolerance. In arid and semi- arid areas it is recommended to use more salt tolerant crops in order to minimize the leaching requirements and planning leaching at periods of low crop water use or after cropping. In areas, where the infiltration rates are low it is important to plan for pre-planting leaching. In certain instance, after leaching it is advisable to plant salt tolerant crops such as barley, rice, and cotton.

2) Drainage

Salinity problems in irrigated agriculture are frequently associated with inadequate drainage that encourages development of water logging, which in its turn can encourage the rise up of water table. In most soils with a shallow water table, water rises into the active root zone by capillary movement and if ground water contains salt, it will become a continuous source of salts to the root zone as water is used up by the crop. When drainage is adequate salinity directly related to the water quality applied through irrigation. To remove salts from the soil, more irrigation water is applied to the field than the crops require. This extra water infiltrates into the soil and percolates through the root zone, while the water is percolating; it dissolves the salts in the soil and removes them with the drained water. Irrigation management becomes a problem if the salts applied with the irrigation water are allowed to accumulate to a concentration, which will reduce crop yields.

Effective salinity control, therefore, must include adequate drainage to control salts and stabilize the water table and leaching as needed to reduce the accumulated salts. In this regard, drainage program for irrigated land should be initiated and continuously integrated with the development of irrigation system in order to attain an efficient management of irrigation water and control development of salinity as well.

3) Applying soil amendments

When salinity has caused a very serious problem and deteriorated the soil structure and resulted in reduced infiltration rates, chemical soil amendments may be the solution. The majority of such amendments that is being commonly used is to add calcium directly to the soil as in the case of gypsum (CaSO_4) or indirectly through an acid substance, such as sulfuric acid (H_2SO_4) or sulfur. The acid substances react with the naturally occurring lime (calcium carbonate- CaCO_3) in the soil to release calcium in the soil. Therefore, increasing the soluble calcium content in the soil solution can reduce the sodium to calcium ratio and the sodium absorption ratio and therefore, improve the structure of the soil, which will improve water infiltration of the soil.

The reaction takes the following steps:

1. $\text{Na}_2\text{CO}_3 + \text{CaSO}_4 \longrightarrow \text{CaCO}_3 + \text{Na}_2\text{SO}_4$
2. $2\text{NaHCO}_3 + \text{CaSO}_4 \longrightarrow \text{Ca}(\text{HCO}_3)_2 + \text{Na}_2\text{SO}_4$
3. $\text{Ca}(\text{HCO}_3)_2 \longrightarrow \text{CaCO}_3 + \text{H}_2\text{O} + \text{CO}_2$

Success of gypsum application in irrigation water or soil depends upon the choice of the grade of gypsum, its particle size, method of application and quantity applied. Gypsum could be mixed directly in irrigation water or with the soil. Gypsum and other soil amendments will not bring any significant improvement if the very low infiltration rates are caused by compaction of the soil, the presence of hard pans or clay lenses, a high ground water level or an adverse soil structure. Furthermore, a number of chemical fertilizers can also prove beneficial by supplying calcium to the soil, notably calcium nitrate- $\text{Ca}(\text{NO}_3)_2$, calcium ammonium nitrate- CAN and the two main sources of phosphate, single and superphosphate (SSP and TSP).

The following chemical reaction illustrates the manner in which some soil ameliorants react with alkaline soils:

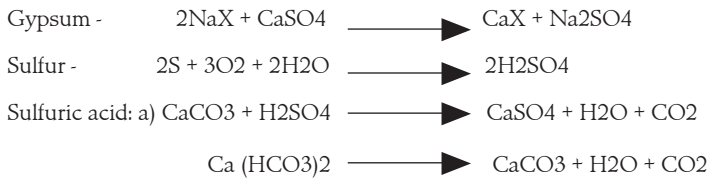

4) Selecting of tolerant crops to salinity

If saline irrigation is used, a salt tolerant crop may be required to avoid yield reductions. All crops do not respond to salinity in similar manner; some crops can produce acceptable yields at much greater soil salinity than others. In this regard, crops like barley and cotton are tolerant to salinity and can be produced in areas where salinity problem is critical, whereas crops like sorghum, soybean, wheat, pineapple and papaya are also moderately tolerant to salinity. However, it should be understood that selection of a salt- tolerant crop will not completely eliminate the need of leaching, but the leaching requirement might be reduced.

5) Cultural practices

The primary management options to control salinity such as adequate drainage, leaching, changing to more salt tolerant crop that requires less leaching for adequate salt control are the most appropriate for long- term salinity control. But in addition to the aforementioned long- term options there are also separate cultural practices that can have a profound effect upon germination, early seedling growth and ultimately on crop yield. These short- term cultural practices that aid in salinity control become more important as the irrigation water salinity increases. These include land smoothing for better water distribution, timing of irrigations to prevent crusting and water stress, placement of seed to avoid areas likely to be salinized, and care in selection of materials, rate and placement of fertilizers.

i. Land smoothing or grading

In areas where there is salinity problem the farm land should be sufficiently graded for better distribution of irrigation water. Usually, salts are accumulated in the high spot areas, while water accumulates in low- lying areas which causes water logging and creates potential drainage problem. Therefore, germination is generally poor in high spot areas and similarly, the crop stand is also poor in low- lying areas, where water logging is a problem. Land smoothing simply smoothes the soil surface and usually done annually to ensure uniform distribution of water when annual crops are changed. But land grading is a process of cutting and transporting of portion of the top soil surface in order to raise the level of low- lying parts within the same field. Land grading or smoothing usually causes compaction of soil layers, due to heavy equipment, therefore, after these operations it is advisable to sub- soil, chisel or plough the land to break up the compaction layers and improve water infiltration.

ii. Timing of irrigation

The timing of irrigations to prevent water stress of crop plants will improve at the same time salinity control. Irrigation timing may include increasing the frequency of irrigation, irrigating prior to a rainy season, and using pre-plant irrigation to leach down the excess salt accumulation on the active rooting zone and this will improve the germination of crop seeds. Therefore, the main objective of timing of irrigation is to reduce salinity and avoid water stress of crops between irrigations. Water stress eliminated by increasing the frequency of irrigations, thereby preventing excessive root zone depletion that might be caused by extended interval between irrigations. In another word, by decreasing irrigation intervals, higher soil- water availability is maintained.

In hot and dry areas when using irrigation water with high salt concentrations, water can accumulate rapidly near the surface, due to high evaporation rates, particularly during non- crop periods and if associated with high water table. Under such conditions, seed germination, seedling development and yield may be seriously reduced. Therefore, pre- plant irrigation to leach down excess salts accumulated on the surface is highly important. Sometimes applying of irrigation water at germination and seedling development using sprinklers is essential to reduce salinity to obtain better germination, to lower surface soil temperatures and improve early seedling growth and can be followed by furrow irrigations.

iii. Placement of seeds

Salinity reduces or slows germination and it is often difficult to obtain a satisfactory crop stand of furrow irrigated crops on saline soils or when using moderately saline irrigation water. Sometimes farmers may increase seeding rates to maintain higher plant density but may also result in additional thinning costs and even then the plant population may not be uniform and increased crop yields cannot be assumed. A better alternative might be to make appropriate adjustments in planting procedures to ensure that the soil around the germinating seeds is sufficiently low in salinity. Therefore, suitable planting practices, bed shapes and irrigation management can greatly enhance salt control during the critical germination period.

With furrow irrigated crops planted on raised beds, water movement is from the furrow towards the top of the bed and salt accumulates there and the seeds might direct contact with the salt and the salt can damage the seeds. In this case, it is important to place the seeds not on top of the raised beds but planting of seeds off- centre or on the shoulder of the beds closest to watered furrow, where the salt concentrations are less can result in better seed germination. If double row planting is practiced the seeds should be planted to the sides of beds far of the centre, but double row plating with alternate furrow irrigation is not recommended as salts accumulate in the second seed row from the wet furrow.

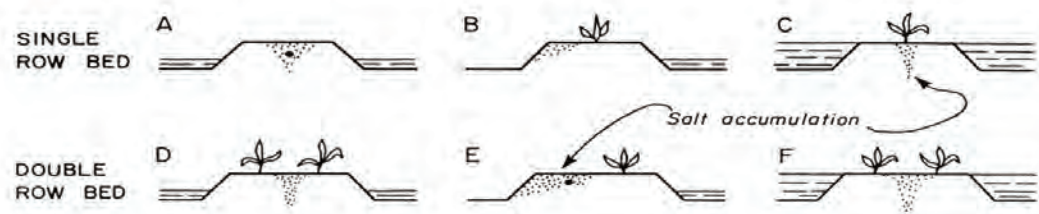

Fig. 20. Flat top beds and irrigation practices (source: Water quality for agriculture)

Another widely used modification of the single- row sloping bed is shown in fig.19; it is used for both salinity and temperature control. The seeds are just planted above the water line in the furrow. In hot climate areas, where cooler temperature is desired, the sloping bed should face away from the direction of the sun.



Fig.21. Salinity control with sloping beds irrigating on both sides of the furrow (source: Water quality for agriculture)

iv. Fertilization

Fertilizers, manures and soil amendments include many soluble salts in high concentrations. If placed too close to the germinating seedlings or to the growing plant, the fertilizer may cause or aggravate a salinity or toxicity problem, particularly when the fertilizer is drilled in the row. Therefore, care should be taken in placement of the fertilizer and timing of fertilization. Split application is beneficial in saline soil in order to avoid salt build up from the fertilizer itself. But salt tolerance of a crop is generally considered to be less affected by raising the level of soil fertility required for optimum growth. However, if both salinity and low soil fertility is a problem correction of both factors can improve crop yield.

v. Changing methods of irrigation

The method of irrigation directly affects both the efficiency of water use and the way salts accumulate. Flood and sprinkler irrigation methods designed to apply water evenly over the entire irrigated area assuming the land is well leveled. This results in most of the salts accumulating in the lower root zone. The degree of accumulation depends upon the leaching fraction. However, in the case of furrow irrigation, salt builds up with depth in the soil and at the same time salt accumulates in the areas not covered with water. Salt moves with water to the high points where the water evaporates most rapidly and is leached to greater depths as water drains by gravity. For localized irrigation, salts accumulate at the edges of the soil wetted from the emitter. In this case, salt concentration is highest at the outer edges of the bulb.

Isolated pocket areas accumulated salt frequently as result of poor water infiltration and insufficient leaching. These can be raised areas, areas with dense soil, or areas not getting sufficient water during irrigation. These can be easily recognized by bare spots or areas of reduced/stunted growth. Each irrigation method has certain advantages and disadvantages and all known factors should be considered before attempting to improve salinity control by changing the method.

6) Land development for salinity control

Practices that could be applied during land development include land levelling, establishing of adequate drainage, deep ploughing to alter soil profile physically and leaching to reduce excessive salinity. However, these operations are costly and require special skills, which are not applicable at subsistence level.

7) Changing water supplies

Changing water supplies to control salinity is simple operation. However, this is only possible if better quality water is available. But this is not practical in most cases, particularly in areas where there is a water supply shortage. Even some times the saline water can be blended with better quality water. In this case, the quality water can be applied at germination and seedling development stages to avoid salinity damage and the saline water can be applied at the later growth stages, which are less sensitive to salinity.

Module 11

Objectives:

After reading this chapter, readers and/or participants will be able to:

- describe the major factors governing cropping pattern
- understand and acquired skills on developing cropping pattern for different agro- ecologies

The term, cropping pattern refers to the yearly sequence of crops grown and the spatial arrangement of them in a given area. Cropping pattern formulated with the view to obtain maximum crop production per unit area under a given situation. Cropping pattern is a result of many years experience of farmers that could be developed further based on the governing factors. Therefore, cropping pattern may gradually be changed depending on the prevailing conditions of the specific localities. A cropping pattern shows what crops are to be grown in a given irrigation project area, intensity of cropping and percentage of each crop grown when it is planted and time of harvest. It is also important to indicate the total growing period and the length of each agricultural activities including planting and harvesting.

12.1 Factors Governing Cropping Patterns

There are many factors governing the cropping pattern in an irrigated project area. The most important ones are: climate, soil characteristics, rainfall, water allowance and full supply days, water and irrigation requirement of crops, intensity of irrigation, intensity of cropping, farmers' requirements for food, fodder, fibre and cash, size of land holding and family, marketing and other physical infrastructures, availability of credit facilities and selection of appropriate crop varieties more suitable and adaptable to the given area.

12.1.1 Climate

Climate is the most important consideration for selecting crops for an area under irrigation. Crops have varied climatic requirements and give optimum yields when they are grown under optimum conditions. Crops that are more adaptable to the lowlands are not successful in the highlands. Similarly, crops more adaptable to the highlands cannot be grown in the lowlands.

Thus, in designing a cropping pattern the first step is to choose crops that suit the climatic conditions of the area under consideration. In particular, in relation to temperature; not all vegetables tolerate hot weather, while others actually prefer it. Heat tolerant vegetables like eggplant, cucumber, and okra will do quite well in mild weather too, but "cool season" vegetables like head lettuce, peas, and cauliflower won't produce reasonable yields in hot weather. In the contrary, crops like maize, wheat, sorghum, groundnut, bean, cotton, pepper, tomato, citrus and some other crops are sensitive to frost. Therefore, these crops should be cultivated during frost- free periods. Diseases are generally more prevalent under high rainfall and humid areas, but some crops may suffer more

than others. Tomatoes, eggplant, peppers, cucumbers, and melons are among the more sensitive crops to humidity and significantly affected by diseases.

12.1.2 Soil characteristics

Soil is used as a media for holding water, air and soil nutrients essential for normal plant growth and development and obtained an optimum yield depending on the natural fertility status of the soil and other management factors. In addition, soil serves as a media for planting of crop seeds and development of root systems and holds the plant in up right position. Suitability of crops to particular soil is largely decided by its physical and chemical properties. Soil texture, structure, depth of soil, conditions of subsoil drainage, fertility, soil reactions and presence or absence of harmful salts are major soil related factors that should be taken into consideration in deciding the cropping pattern of an area that should be grown for optimum yields. Crops such as rice, sugarcane, and cotton require heavier soils, while groundnut, potato and sweet potato require lighter soils. Root crops usually prefer sandy or loamy soils since high clay content may hinder root or tuber growth and development as well as harvest operations.

Shallow soils do not allow good growth of crops with deeper rooting system. Soils with excessive moisture or poor drainage conditions are harmful for most of the crops, except that of paddy rice, which grows well in water-logged conditions, sugarcane can tolerate excessive moisture for some period, whereas most irrigated crops such as tomato, pepper and most vegetables cannot tolerate excessive moisture conditions and are moderately salt sensitive crops, whereas barley and cotton are considered as salt tolerant crops and can be grown relatively in salt affected soils and give better yields. Similarly, choice of crops depends on soil reactions. Rice, linseed and wheat can be grown in moderately acidic soils, while barley and potato are grown in slightly alkaline soils.

12.1.3 Rainfall amount and its distribution

The major water source in Ethiopia for crop production is rainfall. Therefore, the distribution pattern of rainfall, its amount and intensity are important factors in deciding the cropping pattern of a given irrigation project area. Periods of higher rainfall, rainfall intensity and periods of drought should be taken into account along with the availability of irrigation water before selecting crops. Certain crops such as sorghum, finger millet and the like can tolerate droughts to some extent, while, rice, sugarcane, maize and leafy vegetables can withstand heavy rainfall. Selection of crops thus, depends on the amount of rainfall and its seasonal and periodic distribution in a region and the availability of water at times of need and its quality. In addition, availability of ground water and the depth of water table can also affect the choice of crops to be grown.

12.1.4 Water allowance and full supply days

The term, water allowance, signifies the amount of water available for full supply days in a year and is, generally, expressed in cubic meters per second per 1000 ha, ($m^3/sec/1,000$ ha), cultural command area. The number of full supply days in a particular month of the year is decided on the availability of water from the source in that month. The water allowance for that particular zone is usually determined following the water and irrigation requirements of crops, area under crops, cropping sequence and rotations and availability of irrigation water. When irrigation water is not sufficient according to needs, water allowance may be rigidly fixed. For allocating water allowance, the area

proposed under irrigation is divided into different zones, based on the requirement of irrigation water of crops. The amount and distribution of rainfall, existing irrigation water availability and depth of water table are taken into consideration. In the zone with crops, which are susceptible to drought, water is supplied throughout the year except during the month of heavy rainfall, in the zone of crops with moderately susceptible nature, water is supplied year round. Selection of crops is made according to the water allowance and the number of full supply days. The number of full supply days in a particular period has a direct relation to the water availability, crop needs, season and type of crops to be grown.

12.1.5 Water and irrigation requirements of crops

Water and irrigation requirements of crops and water use efficiency are very vital in deciding the cropping pattern. When rainfall and a relatively high water table meet a part of water requirement of crops, irrigation requirements of crops are considered while deciding crops and the area under them. In areas of limited water supply, crops with lower water requirements are preferred. Usually two crops with almost similar economic return but having different water requirements, the crop with lower water need has a preference as more area can be brought under irrigation with a greater total return with a given quantity of water. This is intended to make more profitable use of limited supply of irrigation water during the dry season.

12.1.6 Intensity of irrigation

Intensity of irrigation is decided according to water supply and area to be irrigated keeping in view the agriculture of the area. *Intensity of irrigation* means the area proposed to be irrigated per 100 ha of cultural command area and usually expressed in percent. When the supply of irrigation water is limited, intensity of irrigation is fixed before hand and the cropping pattern is evolved accordingly.

12.1.7 Intensity of cropping

Multiple cropping is practiced when supply of water is assured during the scarcity periods and the intensity of cropping depends on the quantity of water made available during the irrigation season. The area under single or multiple cropping is mainly decided according to intensity of irrigation and the types of crop varieties to be grown. The areas to be brought under different crops in different seasons are decided according to the agro-climatic situations of the tract. Where possible the cropping intensity is desirable to approach 200 %. But from practical point of view under Ethiopian condition, even it is preferable to aim at a cropping intensity of around 100-120 % under minimum management input, 120- 150 % for medium input, 150- 180 % for higher management input and 180- 200 % under intensive commercial management. Therefore, in order to achieve these different levels of cropping intensity requires selection of short, medium and long maturing crop varieties adaptable to the specific area.

12.1.8 Farmers' preference and size of landholdings

The proposed cropping pattern should have a close relation to requirements of farmers. The areas to be put under crops, selection of crops and crop sequences are guided by the needs of farmers for food, fodder, oils, vegetables, pulses and cash. Once that is decided, the proportion of area to be put under various crops during different seasons and the irrigation intensity are finalized. Crops selected and the area to be put under them would, of course, vary according to the climate, soil

characteristics, marketing facilities, prices of produce expected and so on. The basic idea, here, is to recognize the needs of farmers, particularly of those having smallholding, and to make them economically self-dependent. The need of the family plays a dominant role in deciding the types of crops to be grown and the area to be put under them. Farmers having smallholding prefer more area under food crops without considering much on economic return of crops grown, whereas, farmers owning bigger farms prefer cash crops rather than food or other crops with expectation of higher economic returns. Areas under different crops are, however, adjusted within the limits of water allowance and irrigation intensities.

12.1.9 Marketing, transport and other facilities

Facilities such as good markets, roads, transport and storage facilities govern to great extent the cropping pattern of a tract. Vegetables are grown more in areas around cities, as there is a big demand for vegetables in city markets. Cereals and other nonperishable crops are grown in distant places from markets, as they are not likely to be damaged on long transit and for delay in marketing centres of demand create a special preference for a crop around the centre, such as sugarcane, around a sugar mill. Good roads and availability of transport facilities are important to be considered for ease and quick movement of agricultural produce. Perishable agricultural produce can be transported to distant markets quickly to fetch a higher profit. Many vegetables are highly perishable which limits their transportability to more distant markets unless refrigeration and other facilities are available. Others like cabbage, carrots, beets, sweet potatoes, and other root crops store and ship well. Therefore, storage facilities, particularly cold storage, encourage farmers to grow crops like potato, vegetables and fruits that promise usually high profits and good returns.

Market price as determined by supply and demand influences crop selection but in a rather haphazard manner. Farmers often tend to get locked into a monoculture pattern, which limits their flexibility even though feasible crop alternatives exist. Consumer preference is a critical consideration and must be determined before embarking or initiating vegetable growing to a new area. Furthermore, nutritional value and consumer acceptance is very critical to consider in deciding choice of crops to be cultivated. Commercial farmers rarely consider this as a factor, but it's important for home and smallholders. Vegetables vary markedly in their vitamin content. Eggplant, cucumber, onion bulbs, and beetroots are notably low in food value, while carrots, collards, mustard, and broccoli are excellent in their vitamin content (especially vitamin A). The vitamin content is closely correlated with leaf exposure to sunlight in the case of leafy vegetables. Of course, taste of the family or consumers is also essential in selecting vegetable types.

12.1.10 Credit facilities

Economic conditions of most farmers in Ethiopia are at subsistence level. A cropping pattern involving high value as cash crops needs facilities of irrigation and more investment. For general acceptance of such a cropping pattern, credit facilities from Banks and other financial institutions should be provided. In general, resource poor farmers are inclined to grow crops like cereals and pulses that require a low investment and usually used for home consumption. So, for evolving improved cropping patterns in irrigated areas, facilities for adequate credit to purchase the required agricultural inputs should be considered along with the economic conditions of farmers.

12.1.11 Labour availability

Economic conditions of most farmers in Ethiopia are at subsistence level. A cropping pattern involving high value as cash crops needs facilities of irrigation and more investment. For general acceptance of such a cropping pattern, credit facilities from Banks and other financial institutions should be provided. In general, resource poor farmers are inclined to grow crops like cereals and pulses that require a low investment and usually used for home consumption. So, for evolving improved cropping patterns in irrigated areas, facilities for adequate credit to purchase the required agricultural inputs should be considered along with the economic conditions of farmers.

12.1.12 Selection of appropriate crop varieties and crop diversification

Successful vegetable production starts with the selection of a suitable adapted variety of a crop to a given locality. The yield difference between an adapted variety and one that isn't can easily make the difference between profit and loss. Therefore, it is important to have the following information in selecting the most adaptable and high yielding varieties:

- A list of recommended varieties for different parts of the country should be made available;
- Time to Maturity: Varieties are classed as early, medium, and late. Although early varieties reach harvest sooner, yields tend to be lower than longer duration varieties. However, they may be advantageous in terms of hitting the early market, avoiding disease build up, and enabling more crops to be grown in the same field.
- Resistance to disease, nematodes, and physiologic disorders: Resistance to these problems varies a lot with the variety and is a very important consideration in selection;
- Color, shape, size, quality, storability, etc.: Market considerations have great role to play;
- Heat or cold tolerance: Heat tolerance is an important factor, and there is some variation among varieties, especially less heat tolerant vegetables;
- Growth habit and duration of harvest: Determinate vs. indeterminate tomato varieties, etc.

12.1.13 Method of irrigation

The decision on the irrigation method to be used and water management practices is basically based on the water resource available, soil type, socio- economic and institutional capacity. In this regard, the method of irrigation to be used affects the crop type to be selected as well. Therefore, selection of crops vary with the type of irrigation method under consideration such as crops suitable for surface method might not be similar with that of crops grown using sprinkler or drip irrigation method.

12.1.14 Availability of agricultural inputs

The productivity of crops in Ethiopia is below the potential both under rainfed and irrigated agriculture. The major reason for that is the low level of input utilization and limited availability and supply of the required inputs on time and space. Rainfed extension packages approach have shown that the productivity level of crops per unit area can be increased significantly by using

agricultural inputs and other improved crop management practices. Therefore, in selecting the cropping pattern it is also important to consider the experience of input utilization of farmers and availability of the required inputs with affordable prices.

12.2 Developing Cropping Pattern

Considering all the factors discussed above it will be important to introduce a mix of crops to supplement the dietary condition of the farmers. In the cropping pattern preferably be included those crops with high production potential considering the soil and other environmental factors of the area, have greater demand for domestic consumption and better prices both in local and international markets. In addition, in irrigated agriculture it is recommended to cultivate short season crop varieties that will fit in double cropping system. In order to develop a cropping pattern in a tract, it is essential to know the physical environments and socio-economic conditions of the area. Therefore, basic data on climatic and soil conditions, hydrology, geology, major crops being grown, water availability and irrigation requirements of crops, existing cropping pattern and agricultural practices, availability of labour, marketing facilities, sizes of family and land holdings, and farmers' preference must be gathered and analyzed thoroughly.

Besides, investigations are needed to know the possibilities of introducing new crops and varieties, possibilities of multiple cropping, application of advanced agricultural techniques, availability of agricultural implements and machineries and expected capital requirements, availability of credit facilities and water availability both in quantity and quality. A cropping pattern is evolved as a model for farmers. They are then able to adjust the model to make the best use of the available resources. Whenever, the construction of an irrigation project is proposed, it is essential first to evolve a cropping pattern for the command area to facilitate proper utilization of the project potential and to make the project economically viable. Improper planning may lead to injudicious use of water, increase water table, creating water logging, development of salinity and alkalinity, and gradual loss of soil fertility that reduce crop yields.

Considering the factors discussed above the following general cropping patterns are recommended for major agro- ecologies of Ethiopia (Table 24). As a general guide, when developing a cropping pattern for a tract it is important to consider about 60- 75 % of vegetables, 15- 25 % of cereals or food crops, about 10 % of oil and fibre crops and 5- 15 of fruit crops. However, the proportion of fruit crops in lowland areas will increase from lower to higher percentage.

The Moist Wurch zone, which is characterized with an altitude range of 3 200 and 3 700 m a.s.l has an annual rainfall from 900 - 1 400 mm. The average temperature of this zone is 7 - 12 °C. In this zone the main crops are barley and potatoes. The rainfall amount and its distribution are sufficient for rainfed agriculture. Heavy runoff and degraded shallow soils of brown to grey colours are widespread. The Wet Dega zone, which is characterized with an altitude range of 2 300 and 3 200 m a.s.l has an annual rainfall over 1 400 mm. The average temperature of this zone is 12 to 18 °C. The main crops are also barley, wheat and pulses. Degradation is widespread and gullying is frequent, as a result of soil erosion. Soils are variable, with mainly brown clay loams on slopes and are shallow in depth. Irrigation activities are not common in these areas.

Table 24. General recommended crop mix for major agro- ecologies of Ethiopia

No	Major agro- ecological zones	Altitude (m)	Average temperature (°C)	Annual Rainfall (mm)	Recommended crops
1	Moist Dega	2 300 – 3 200	12 - 18	900 – 1 400	Barley, Wheat, Highland Pulses, Potatoes, Cabbage, Carrot, Swiss Chard
2	Moist Weyna Dega	1 500 – 2 300	18 - 25	900 – 1 400	Teff, Maize, Wheat, Pulses, Sorghum, Nug, Potatoes, Sweet Potatoes, Cabbage, Carrot, Swiss Chard, Shallot, Onion, Pepper, Tomato, Garlic, Coffee
3	Dry Weyna Dega	1 500 – 2 300	18 - 25	300 – 900	Maize, Wheat, Groundnuts, Haricot beans, Sweet Potatoes, Shallot, Onion, Pepper, Tomato, Swiss Chard, Coffee, Banana, Papaya, Citrus
4	Moist Kolla	500 – 1 500	> 25	900 – 1 400	Maize, Groundnuts, Haricot beans, Sweet Potatoes, Shallot, Onion, Pepper, Tomato, Banana, Papaya, Citrus
5	Dry Kolla	500 – 1 500	> 25	300 – 900	Maize, Sorghum, Groundnuts, Haricot beans, Cotton, Sweet Potatoes, Shallot, Onion, Pepper, Tomato, Banana, Papaya, Citrus

13. IRRIGATION AND FERTILIZER USE

Module 12

Objectives:

After reading this chapter, participants will be able to:

- describe the synergistic effect of irrigation and fertilizer use for optimum crop yields;
- better understand the relationship between water and nutrient availability and their uptake in irrigated condition for increased irrigated crops yields;
- describe the major factors that affect the use of fertilizers;
- understand methods of fertilizer needs determination and their proper application

13.1 Synergism of Irrigation and Fertilizer Use

Crop growth is a function of soil- water and yield is a function of normal crop growth and development. When water supply is not limiting, crop growth and yield are a function of nutrient supply in soils, provided other production factors are not limiting and are maintained at optimum level. When the rainfall in an area is inadequate, the crop response to fertilizer application depends on supply of assured irrigation water. Again, with increasing supply of water crop yields go on increasing trend as a result of fertilizers application, of course without causing damage to the environment. Availability of adequate water in the soil increases the fertilizer use efficiency with increasing dose of fertilizers to economic optimum level to boost up crop yields.

Fertilizer and irrigation show synergistic effect and their combined application results to excellent crop growth and yield more than the sum of their independent effects. The positive and significant interactions between them favour their application to crops. Therefore, irrigation to be efficient and highly beneficial in crop production requires a good and balanced application of fertilizer nutrients. The availability of nutrients and their uptake are very dependable on the amount of water available in the soil. Thus, the availability of nutrients and their uptake are highest when the soil water is adequate and available at low tension.

13.2 Water and Nutrient Availability in the Soil

Under rainfed conditions, use of fertilizers is limited mainly because of inadequate supply of water. The relationship between water in the soil and the uptake and use of plant nutrients is very complex, since the water status in the soil and changes in soil water conditions have major effects on the availability of soil nutrients, on losses of nutrients from the soil and extent to which plants take up nutrients and use them for their growth and yield formation.

Both the availability of nutrients and their absorption by crops become poor under dryland conditions. This leads to poor crop growth and reduced yields. Therefore, water content of the soil greatly affects the availability of soil nutrients to crop plants. In dry soil conditions, biological activity in the soil is restricted, so that the breakdown of organic matter slows down and as a

result, mineralization of organic forms of nitrogen to plant- available mineral forms also cease. In dry soil conditions the availability of nitrogen in the soil is highly restricted. At the same time, mineralization of other nutrients, such as phosphorus and sulfur is also inhibited. Thus, the use of irrigation can improve soil biological activity and increases the breakdown of organic matter and as a result, mineralization of organic forms of nitrogen improves the soil nutrient supply that has a great role to play for good plant growth and to obtain a promising harvest.

Availability of soil nutrients already in mineral form is also improved by a satisfactory soil moisture status. In this regard, in dry soil conditions, cations are more lightly bound to moisture colloids and, therefore, less available to plants and the plant will not be able to absorb sufficient nutrients from the soil.

13.3 Nutrient Losses

In waterlogged soils, the concentrations of ammonium ions, iron, phosphorus and manganese increase, but nitrate content falls down because of the loss of nitrogen, due to denitrification. The process of *denitrification* is defined as the process of converting nitrate- plant available nitrogen, to nitrogen gas or oxides so that considerable amounts of plant- available nitrogen may be lost. Denitrification process of nitrate occurs in an anaerobic condition as follows:

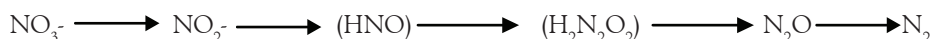

There are three cases, in which water status and water management practices may influence loss of nutrients from the soil- plant system:

1. Excess irrigation water resulting in the passage of water through the soil profile that will carry down soluble nutrients with the irrigation water, particularly that of nitrate, sulfur and boron /leaching/;
2. Waterlogging causes denitrification of nitrate by converting plant available nitrate forms back into molecular nitrogen or as nitrogen gas, which is not available to plants;
3. Ammonia volatilization from urea and some ammonium- containing fertilizers is influenced by soil water status. When soil moisture status is rapidly losing water by evaporation, volatilization of ammonium (NH_3) is appreciable.

13.4 Nutrient Uptake and Use in Irrigated Condition

The uptake of nutrients by crops is also influenced by the effect of water supplied to the crop that can have further an impact on crop growth and the overall metabolic activities of the plant. If water uptake is restricted by dry soil conditions, the rate of root extension is reduced and the plant is less able to draw water from moist horizons of the soil and as a result, the overall plant growth and development processes are affected and a pronounced yield reduction could be observed. The quality of grains and other plant parts improves by the application of adequate water and plant nutrients. It is generally known that nutrient contents of plant parts increased when adequate amount of nutrients are supplied and soil moisture is adequate.

Efficient use of nutrients after uptake depends on a satisfactory continuing supply of water. If

sufficient water is not available, transport of nutrients within the plant system can be restricted and their use for metabolic activities and plant biomass production will also be limited. The growth and yield response of the crop to fertilizer are very much influenced by the level of water supplied to the crop. The response is a synthesis of the various factors affecting crop growth, among which nutrient availability and uptake are the major ones that affect normal crop growth and subsequently reduce crop yield.

13.5 Water and Fertilizer Response

The actual yield level and the response to fertilizer application are very much influenced by the level of water supplied. Crops can't utilize nearly as much fertilizer when moisture is limiting, although low to moderate rates will help improve water use efficiency. Their response is a synthesis of the various factors affecting crop growth, nutrient availability and their uptake. Therefore, in relation to water supply management, nutrient use efficiency may be improved by:

- Minimizing fertilizer losses from the upper soil layer of active rooting zone by maintaining efficient use of irrigation water and avoiding application of excess water that can cause leaching of nutrients beyond the rooting zone down to a depth from which the plant is not able further to extract them;
- Losses of nitrogen through the process of denitrification, which is caused, due to poor water management practices can be prevented by draining out of the excess water and
- Avoiding water shortage at any growth stage of the plant.

The presence of adequate water in soils increases the fertilizer use efficiency and increased dose of fertilizer that may boost up crop yields. This confirmed again, the fact that fertilizer and irrigation have synergistic effects and their combined application results to higher crop growth and yield more than the sum of their independent effects.

However, under dry land conditions, use of fertilizer is limited mainly because of inadequate supply of water, whereas in areas with adequate soil moisture both the availability and absorption of nutrients by crops increased. Crop response to nutrients increases with the increase of water supply as the water availability enhances the availability, absorption and utilization of nutrients by plants. Increased supply of nutrients, particularly nitrogen results in higher canopy development, greater photosynthesis, increased growth rate and delayed crop maturity. In irrigated agriculture, fertilizer requirement is normally high. It can be decided in relation to expected yield level, and calibrated by the results of field trials on the local soils and under local management practices. Both fertilizer use efficiency and water use efficiency will be maximized by providing adequate amounts of both inputs for full crop growth and high yield, by timing applications that crop nutrient and water needs are met at all times.

Fertilizer promotes profuse and deeper root system development, which enables crop plants to extract higher quantity of water and nutrients from deeper soil layers. The quality of grains and other plant parts improve by the application of adequate supply of water and nutrients. Nutrients and water requirements of crops are intimately linked with each other. Fertilizer application increases the water use efficiency /WUE/ and at the same time makes possible an efficient use of

fertilizers. Crop yield increases with the increase in evapotranspiration. In this regard, in irrigation agriculture, in order to become profitable it is advisable to grow high yielding varieties of high value crops with the optimum application of manures and fertilizers. Farmers are often tempted to apply heavy irrigation when abundant supply of cheap irrigation water is available. However, this inappropriate practice leads to leaching down of available nutrients from the upper soil layers. This problem is, particularly serious in highly permeable soils and in early development stage of the crop when the root system is shallow.

13.6. Factors Affecting Fertilizer Use

The profitability and the rate of fertilizer to be used depend on the type of crop and variety, soil type, climate, economic and management factors. In addition, the appropriate way of application and actual amount of fertilizer use depends also on know-how and experience of the farmers and the availability of technical information to make the best use of fertilizer.

13.6.1 Crop factor

Fertilizer can hardly be profitable unless the crop is responding to it. Some crops need relatively large amounts of certain nutrients and the others need less depending, primarily on the crop nature and yield potential. Given adequate moisture and an appropriate variety, cereal grains, most pulses, most vegetables, bananas, sugarcane, and pastures tend to show more response to fertilizer than coffee, cacao, and most tree crops. For example, legumes need less amount of nitrogen nutrient, whereas cereals on the other hand need large amounts of it.

The crop variety also makes the difference. As a matter of fact improved varieties respond well to fertilizer application than the local cultivars. In this case, improved varieties will produce much higher yields than the local cultivars, if adequate plant nutrients are available and perform poorly, when inadequately fertilized. In fact, the amount of fertilizer use per unit of area increases when high value crops are produced under irrigation. In relation to crop factor the total crop growing period, root system, naturally nutrient fixing capability of the crop and yield potential of the varieties under use are some of the parameters that determine the amount of fertilizers to be used.

13.6.2 Soil factor

The ability of soils to supply plant nutrients varies from soil to soil and from time to time. The fertility of most soils declines considerably, as a result, of intensive cultivation because of continuous removal of nutrients with harvesting grains. Therefore, it becomes necessary, to supply more and more of plant needs by applying fertilizer to the soil.

Physical properties of soil such as shallow depth, low permeability are likely to be less responsive than deep soil and medium permeability of soil to optimum fertilizer applications. The optimum amount of fertilizer to be used on such soils is less than it is on more productive soils. It is, then, strongly advised to supply fertilizer to soils that are most responsive and should not attempt to obtain same crop yields on soils that have different potentials. Therefore, large applications of fertilizer can be profitably used on soils that have high potential, but low fertility status. Moisture status of the soil highly determines the amount of fertilizer to be used and the nutrient uptake and availability to plants.

13.6.3 Climatic factor

Relatively less amount of fertilizer is used in areas receiving less than 400 mm of precipitation per annum, unless supplemented by irrigation. Actually, soils in these particular areas have lost little nutrients by leaching and their inherent fertility level is relatively high. The limiting factor is the amount of water available for plant growth that does not justify using fertilizers to raise their fertility level. In the contrary, crops grown in sufficient rainfall areas usually need fertilizer to produce high yields. Because most soils in areas receiving high amount of rainfall have the possibilities to loss significant amounts of plant nutrients by weathering and leaching. The water supply is adequate for high production, but productivity is usually limited by plant nutrients supply, unless fertilizer is used.

13.6.4 Economic factor

Fertilizer use is increased with low prices of the fertilizer and decreased with high prices like any other commodity. Crop prices have the opposite effect; as a result, of high prices for the crop will give a profitable return from large amount of fertilizer applications. However, the critical challenge in most developing countries of the world like that of Ethiopia is that the consumption of fertilizer is low, due to fertilizer prices are relatively high and the prices of crops is low in the contrary. In this case, the purchasing power of the farmers will be affected and may not be able to buy the recommended amount of fertilizer. In this case, provision of credit will become more important and play a vital role to increase the overall consumption of fertilizer and other inputs in order to get high return from the inputs applied.

13.6.5 Management factor

An application of increased amount of fertilizer is not the only remedial solution to increased production. Instead, it is strongly advised to apply the appropriate amount of fertilizer by taking into account related factors such as soil type, climate, type of crop and variety, fertilizer application history under the previous crops and other agronomic practices. Therefore, it will be important to control effectively all the limiting factors at the optimum levels in order to obtain high yields and make the most profit out of it.

13.7 Determination of Fertilizer Needs

The type and amount of fertilizers to be applied depend on the crop type to be grown and the nutrient- supply capacity of the soils of each specific field. Determination of the level of soil nutrients allows deficiencies to be detected and to calculate appropriate rates of fertilizers to be recommended. There are a number of methods for determining the nutrient status of soils, among which the following are more important to be taken into consideration.

13.7.1 Visual diagnosis

Careful observation of the vegetation existing on the land, particularly the growth patterns of plants, discoloration and malformation of leaves and other parts of the plants, etc is a useful method in qualitative assessment of the soil fertility and the need of fertilizers to be applied. Plants exhibit characteristic symptoms when a nutrient is insufficient quantity for normal growth and

development. These symptoms can be used to diagnose the nutrient deficiency that is present and decide on the remedial action to be taken. The method is rapid and elaborate apparatus is not required, but it has the following limitations /drawbacks:

- The deficiency symptoms must develop before they can be identified and by the time it may be too late to apply remedial measures for the crop, particularly for cereal crops;
- Symptoms of certain deficiencies are not very distinct and may be visible only when the deficiency is acute enough to cut down yield by 30- 60 % and then by the time it may be too late to take appropriate actions;
- Deficiency symptoms may be complicated or suppressed by factors such as weather or pest and disease damage.

13.7.2 Plant tissue analysis

The crop can be tissue- tested, while growing in the field for N-P-K levels in the sap. Plant analysis may be semi- quantitative, as in rapid tissue tests or fully quantitative. Both tests and chemical analysis of the plant sap may be capable of providing an indication of shortage of nutrients, where not serve enough to cause recognizable deficiency symptoms. This method is especially useful to be applied on analysis of perennial or long duration plants such as fruit trees, sugarcane to indicate deficiency symptoms to be corrected on time.

Tissue tests are best used to supplement soil test data, since the results can be tricky to interpret by non-professionals. Sometimes plant sap nutrient levels are not well correlated to those in the soil, because weather extremes, insects, and diseases can affect uptake of nutrients and deficiency symptoms are sometimes confused with. Deficiencies of one nutrient such as N can stunt plant size and cause P and K to “pile up: in the plant sap, giving falsely high readings. The tests are also geared to higher yield levels than most small farmers can reasonably hope to attain. However, the advantage of tissue testing is that it may be possible to correct a deficiency of nutrients, while the crop is still growing and thus increase crop yields. When collecting leaf samples, it is important to pay close attention to the kit provided or laboratory sampling instructions. Because taking leaves from the wrong part of the plant will make results invalid.

13.7.3 Soil test

Soil testing by a reliable laboratory is the most accurate and convenient method for determining appropriate fertilizer rates to be used. Most laboratories routinely test for available P and K and measure soil pH and exchange capacity. Soil testing is a better method than deficiency symptoms and plant tissue analysis, because it helps in determining the nutrient need of the plant before the crop is planted. It is simple and less time consuming if laboratory facilities are available.

Proper soil sampling by the farmer or extension worker is a prerequisite for soil test in order to obtain accurate laboratory results. A 200- 400 gram sample may represent up to 15,000 tons of soil. Therefore, the soil laboratory’s instructions should be carefully read before sampling and the sample should be properly labeled and send to the lab.

13.7.4 Conducting field trials /experiments/

The best way to determine the nutrient needs of crops is to conduct field trials on fertilizers. In the trial sites, fertilizers are applied at known different rates of plant nutrients, crop responses are observed and final yields are measured. Based on the yield obtained the optimum rates of fertilizer are calculated. It is through field trails that the fertilizer rates could be determined accurately. The method has the following advantages:

1. It is the best way to determine the nutrient needs of crops and soils accurately for advising further the farmers;
2. Trials and demonstrations could clearly show the benefits of fertilizers to farmers;
3. Economic evaluation of the results will give a better insight into fertilizer needs;
4. Fertilizer response is easily recognized from the crop performance and plays vital role as demonstration purpose.
5. However, the disadvantages of field experiments are:
6. Expensive;
7. Time consuming and
8. Results are applied to the specific localities and to the crops covered by the experiment.

13.7.5 Making an educated guess

If no soil test results are available for a farmer's field, a reasonable estimate of N-P-K needs can be made based on the following criteria:

- Using available soil test results from nearby farms with the same soil type and a similar fertilizer history, if there is any;
- Using data from fertilizer trials on the same soil type, if they are available;
- Referring to an extension pamphlet on the crop with fertilizer recommendations for the area soils, even though their accuracy is not reliable unless they are based on soil test and/or field trial results;
- The particular crop's relative nutrient needs;
- A thorough examination of the soil for depth, drainage, texture, filth, slope, and other factors that may limit yields or fertilizer response, including soil pH;
- Yield history and past management of the farm regarding fertilizer application and
- The farmer's management ability, available capital, and willingness to use complementary practices like improved seed, insect control, etc.

13.8 Efficient Use of Fertilizers

With the rapid growth of fertilizer use in the world and the considerable escalation in their prices over the years has raised the need to become the most essential to utilize every unit of plant

nutrient in the most productive and profitable manner. Efficient use of fertilizers depends on the application of the right amount of these materials in relation to crop and soil needs. Similarly, for normal plant growth and development and for obtaining optimum yields it will be important to apply fertilizers in the best way and at the correct time when the plant needs.

13.8.1 Optimum application rate

In deciding on the correct amount of fertilizers to be applied it is very important to have information on crop response to fertilizer that could be obtained from results of local field experiments and by taking into account the natural soil fertility status in relation to the quantities of nutrients removed from the soil with the harvested part of the plant. However, in the future it is becoming possible to develop models of response, in particular, to nitrogen fertilizer and to predict fertilizer requirements on an individual field basis. For this purpose local soil and climatic data and information on the variety and other aspects of management supplied by the farmer can be used by the extension agents and run simple computer programme to come up with the appropriate recommendations that can lead to more efficient nutrient use. But in Ethiopian condition, this won't be practicable in the very near future, rather a dream for the long time to come.

Therefore, the more practical approach will be to generate appropriate information by conducting local field experiments on fertilizers and carrying out soil testing and analysis to determine the right amount of fertilizer rates to be used by the farmers of the given localities. In this regard, it is recommended to use local fertilizer recommendations whenever available and/or use the recommendations made available by the former MoA- National Fertilizer and Inputs Unit/NFIU/ in 1995 /for details refer annex V attached/. If the recommendations are given in the form of nutrients then it has to be converted to commercial form of fertilizers to know the exact amount of commercial fertilizers to be used /for detail calculation procedures refer annex VI.

13.8.2 Time of application

The time of application of both organic manure and inorganic fertilizers plays a vital role in determining their effective utilization by plants. The optimum timing of fertilizer application should be determined by the need to make nutrients available over the period or periods at which the crop needs them at the same time minimizing the risk of losses of available nutrients from the top layer of soil, where active nutrient uptake is taking place by crop roots.

The appropriate time for applying a fertilizer depends on the soil, climate, nutrients and the crop itself. With respect to the soil factor, soils differ greatly in the speed of water infiltration and their capacity to fix plant nutrients. Climate is important in any consideration of fertilizer application. The amount of rainfall or the availability of irrigation water between the time of application and the time of utilization by the plant will influence the efficiency of the material. In addition, temperature affects the availability of certain elements; for example, release of nitrogen, phosphorus and sulfur from organic matter. It also affects nitrification and the absorption of phosphorus and potassium by plants. The nature of the crop itself will determine the need for split application. Different crops need different nutrients at different stages of growth and crop development. In this regard, particularly for organic manure it should be applied at least 2 - 3 months before planting and incorporated with the soil in order to have sufficient time for mineralization and release nutrients easily available for plants. The time of application for mineral fertilizers is discussed in detail below.

Nitrogen

Apply nitrogen when you cultivate or transplant. In this way the fertilizer will be well used more efficiently. Most short duration crops have a small demand of nitrogen in the seedling stages of growth, followed by a major demand during the major vegetative growth period. Nitrogen is a very mobile nutrient and is subjected to loss by volatilization and leaching if applied appreciably before the crop can take it up and use it. The degree of risk of loss and the loss mechanisms are through leaching, denitrification, volatilization of ammonia- depends very much on soil and climatic conditions.

In low or moderate rainfall conditions and with a rapidly growing crop it can be quite satisfactory to apply all the nitrogen fertilizer during the last seedbed preparation. On the other hand, where rainfall can be high during crop growth, or where the period of growth is prolonged, a split application with a small dressing to the seedbed and one or more top- dressings during the crop growth will be more effective. This is, particularly true under irrigation condition. Similar conditions of the period of demand and risk of loss apply to every cropping practices will vary very much from crop to crop.

Phosphorus

The annual crop requires phosphorus predominantly in the early stages of growth. Young seedlings need a high concentration of P in their tissues for early growth and root development. In contrast to nitrogen, it is not mobile in the soil, instead it has the characteristic of to be rapidly fixed to soil colloids and is best applied to the soil and incorporated with it during cultivation. When water-soluble or mainly water- soluble phosphorus is used, availability to the young plants will best achieved by applying phosphorus fertilizer in seedbed preparation /or at the time of planting/. If a water- insoluble phosphorus fertilizer such as rock phosphate is used application should be a few weeks before sowing will provide time for some solubilization of the phosphorus to take place and be available for plant use. It is important to remember that applying P in combination with N helps stimulate P uptake.

Potassium

Potassium is required by crop over a longer period of time than phosphorus, but it seldom subjected to serious loss of availability once it is in the soil. Incorporation of potassium fertilizer in the seedbed will provide to be available effectively to the crop with no appreciable risk of loss.

13.8.3 Methods of application

Fertilizer placement is a very important aspect of farming. Most farmers in Ethiopian condition broadcast the fertilizer on the soil surface, particularly for close growing crops. This method of application is not efficient and effective as compared with other methods. Even in some cases, it is considered as wasteful, since the crop may not use certain portion of the fertilizer applied. The nutrients applied may be lost through leaching or volatilization. The best method is, therefore, to incorporate the manure, compost or chemical fertilizer into the soil right after the fertilizer is applied. This method, although requires more time, labour and skill, it is considered by far the best method. By mixing the fertilizers with the soil, the nutrients are placed, where the plant needs

them most, around the active rooting zones, where an active nutrient uptake takes place. In the soil nutrients are also protected from the sun and being washed by rains. These days, due to fertilizer shortages and increased price of fertilizer the farmer must learn how to use his limited resources more economically by considering the soil fertility status and apply the limited resource with skill and wisdom.

Fertilizers are used to supply and supplement nutrients that are not present in the soil in sufficient amounts necessary to meet the needs of the growing crop. In this regard, as a general rule, the best time to apply fertilizer to any crop is before the main crop growth has started. This, of course, will depend on a number of factors that influence the application of fertilizers. Therefore, when choosing the appropriate methods of application, growers or farmers should consider the following:

- Rooting characteristics of the crop to be planted or the planted crop;
- Nutrient requirement of the crop at different stages of growth;
- Physical and chemical characteristics of the soil;
- Physical and chemical characteristics of the fertilizer materials to be applied;
- Availability of moisture;
- Type of irrigation systems being used or planned.

The methods of application are directly related to the crop's utilization behavior of the nutrients and the changes the nutrients undergo in the soil. Chemical fertilizers require more skill to use than organics in terms of rate determinations, dosage calculation, timing, and placement. Therefore, the more appropriate application methods to be employed should be as economic, accurate and efficient as possible. Fertilizers are usually applied in several ways. The principal methods of fertilizer application are: (1) Broadcasting; (2) Local placement /band or side placement/; (3) Foliar application; (4) Aerial application; (5) Injection into the soil and (6) Introduction of fertilizers into the irrigation systems /particularly in pressurized irrigation systems- Application through the irrigation water/.

Broadcasting

Broadcasting a fertilizer is spreading uniformly or evenly over the soil surface with or without working it into the soil by hand or by fertilizer spreader. This method of application is suitable or effective for close growing crops and where large applications are made and for water- insoluble phosphorus fertilizers, for which contact with as much soil as possible is desirable to accelerate solubilization. The application procedure is just simply to broadcast the fertilizer on the field and incorporate with the soil immediately during plowing. In Ethiopian condition, particularly in subsistence farming, fertilizer is preferably be broadcasted by hand, since sufficient manpower is available, but achievement of uniform application requires skill and experience. This is actually being practiced under close growing rainfed crops such as teff, wheat, barley and finger millet.

Placement

Localized placement refers to applying fertilizer in a band, or in a hole, or in half-circle near the seed row or plants. Placement of a fertilizer involves positioning of a fertilizer in specific locations on or in the soil, usually at a specified distance from seeds or established crop rows. Then localized placement has the following advantages over broadcasting:

- By minimizing contact between soil and fertilizer, immobilization of water-soluble phosphorus is retarded and P can be used more efficiently, especially on soils of low available P content;
- Placed fertilizer is usually located near the root zone and is, therefore, readily accessible to the roots of young plants and easily taken up;
- Fertilizer side band near the rows of wide-row crops is used more effectively;
- When the amount of fertilizer available is limited so that low rates are applied and it will be used more efficiently if placed near the active root zones of young plants;
- Deep placement of fertilizer can be more effective than broadcasting if the surface soil dries out during crop growth, since nutrients placed in the soil that remains moist will still be available.
- Fertilizer may be placed at sowing time or during crop growth. Placement may be:
 - In a band at suitable distance from the seed, usually a few centimeters to one side and slightly lower in the soil in two bands on either side of the seed;
 - In a band directly below the seed, which may adversely affect growth of taproots;
 - In a band to one or both sides of plant rows. This is side dressing, where the banding of fertilizers after the plant has emerged. Materials are usually banded along the side of the bed. Appropriate placement ensures to put the fertilizer within the reach of the feeding rooting zone of the plant during the active demand of nutrients is great for normal and vigorous growth.
- Spot application between plants. For urea super granules or in a circular band /ring placement/ around fruit trees. The method of placement varies depending on crop, soil and weather conditions.

Introduction of fertilizers into the irrigation system /fertigation/

Fertilizer can be introduced into the irrigation water using a suitable metering system. This provides good distribution and enables fertilizer to be applied easily in graded doses, depending on the crop requirement of nutrients at different crop growth stages. Non-pressurized solutions and suspensions are, particularly suitable for this application method. Advantages of this method are: saving time, labour, equipment and fuel costs for fertilizer application, uniform distribution by irrigation water, avoiding of nitrogen volatilization from the soil surface, easy for management with specific crop demands at different phenological stages and flexibility in nutrient ratio and possibility of application of the exact amount of fertilizers required that could be controlled through automatic control system in accordance with a pre-established schedule. Applications may be pre-plant or post-emergence, using either liquid or dry fertilizers.

However, the plant nutrients should not be introduced into the system at the start of irrigation water supply, as excessive leaching of certain nutrients may occur. Best results are obtained when the fertilizer application is gauged to enter the system toward the middle of the irrigation water application time and terminate shortly before the set is completed. Application of fertilizers through the irrigation system in this manner prevents the nutrients from being leached beyond

the reach of the plant roots or from lying near the surface, inaccessible to the crop.

Despite, the advantages explained above, the following are the area of concern when applying fertilizers through the irrigation system:

1. Water into which agro- chemicals have been injected should not be used for drinking purpose;
2. Accurate monitoring systems are a must; otherwise there is a possibility of contamination;
3. Fertigation is used for liquid and for solid fertilizers;
4. Insoluble fertilizers should not be applied through the system, since clogging might be critical;
5. Interaction of injected chemicals with the irrigation water should be checked in order to determine whether they are going to cause undesired chemical reaction, resulting in precipitation and increase the pH of irrigation water that in its turn enhancing again precipitation;
6. Corrosion of irrigation and injection system components can be a serious problem so that the materials should be made of chemically resistant materials as to minimize corrosion;
7. Flushing of the overall systems right after each application is essential;
8. The control system should work properly; otherwise fertigation would not be possible.

PART II.

IRRIGATION AGRONOMIC PRACTICES IN MAJOR IRRIGATED CROPS

1. CEREALS

1.1 MAIZE /*Zea mays*/

CROP DESCRIPTION AND ITS USE

Maize is one of the most important long- cycle cereal crops originated in the Andes of Central America. It is the most widely distributed and the most important cereal crop worldwide next to wheat and rice. Maize is a principal food crop reached in starch or carbohydrates, averaging about 71 % on a worldwide basis but comparatively mature, dry maize kernels contain low levels of high quality protein (9.5 %) and some minerals. However, yellow varieties of maize contain significant amounts of carotene, which humans and animals can convert it into vitamin A. The germ protein is of good nutritional quality whereas the endosperm protein is deficient in two essential amino-acids, lysine and tryptophan. Since maize is an energy giving food, particularly in areas where maize is considered as staple food should be supplemented with protein foods such as animal products and grain legumes or oil seeds and with foodstuffs to supply vitamins and minerals to produce a balanced human diet.

Maize is prepared and consumed in a multitude of ways. Maize is an industrial raw material for a growing range of industries and used for preparation of a variety of food items and non- food products. These new applications of maize offer bright prospects for industrializing tropical countries, which has the potential for growing of maize. In the main, however, it is ground and pounded, and the resulting maize meal is boiled, baked, or fried. The green cobs are gathered and grilled. Moreover, maize grain, particularly in tropical regions is used in a variety of ways, as a soup, as maize beer, as porridge and the like. In addition, maize found many non- food industrial application such as the stem and cobs are used to manufacture pulp, wood panels or simply it can be used as a fuel for cooking foods, which is a common phenomenon in Ethiopia. The grain is a source of starch in the manufacture of adhesives, textiles and pharmaceuticals and the protein for varnish. The germ is used for smelting and soap making products. Furthermore, as a deep rooted crop, maize is a good preceding crop in crop rotation cycle for other grain crops that reduces weed problem and minimize the incidence of soil borne diseases and insect pest damage. Maize is also used for livestock feed, particularly the grain is used as a feed for pigs and poultry, whereas the leaves and stalks for cattle.

VARIETIES

Maize in general, has the highest yield potential of all cereal crops. However, in order to grow the crop successfully it is very important to take into consideration the selection of more appropriate varieties adaptable to the existing growing seasons and to the specific growing areas. Under irrigation condition, high yielding varieties of maize are recommended to use, unless and otherwise shortage of irrigation water is a concern to raise high yielding varieties of maize with high demand of water.

The variety should be selected according to its suitability to the specific area and the intended use of the crop. The seed should be clean, disease- free and with a good germination capacity. The recommended maize varieties under production are grouped as hybrid and composite varieties. Among hybrid maize varieties BH- 140, BH- 540, BH- 660 and Phb- 3253 are recommended for use, while A- 511, Kuleni, Katumani, Gutto, and Melkassa- I (yellow maize) are among the open pollinated /composite/ varieties that have different adaptability ranges in different agro- ecological zones /for varietal characteristics refer Table 25/. However, in the absence of well- adapted improved varieties to the specific locality, it is also possible to use local cultivars that have wide range of adaptability with promising yield potential. In addition to the specific agro- ecological variability the irrigation water

availability should be taken into consideration for appropriate maize variety selection. In this regard, short- maturing and composite varieties are preferable in areas with limited supply of irrigation water, while the long- maturing hybrid varieties that require adequate supply of irrigation water need to be cultivated in areas where there is a promising available water resource.

Table 25. Characteristics of maize varieties and recommended areas for cultivation

No.	Varieties	Altitude ranges (m)	LGP (days)	Seed rate (kg/ha)	Productivity (qt/ha)	Recommended areas of cultivation
A	Hybrid V.					
1	BH- 660	1600 - 2200	165- 180	25	70 - 100	Bako, Alemaya, Shashamane, Awassa, Ambo & similar areas
2	BH- 540	1000 - 2000	145	25	50 - 80	Awassa, Bako, Anger Dedessa Valley & similar areas
3	BH- 140	1000 - 1800	130- 160	25	60 - 90	Bako, Anger Dedessa Valley & similar areas
4	PhB- 3253	Below 1900	130- 150	30	60 - 90	Awassa, Alaba & similar areas
B	Open pollinated varieties of maize					
5	A- 511	500 - 1800	140- 150	25	40 - 60	Awassa and similar areas
6	Katumani	Below 1500	90 - 110	25	20 - 30	Moisture deficit areas of the country
7	Gutto	1000 - 1700	100- 120	25	20 - 35	"
8	Melkassa I	500 - 1600	105	25	20 - 30	"

Source: Ethiopia Agricultural Research Organization- Bako ARC, Pioneer Hybrid Seeds Company and previous Awassa Agricultural College.

SOIL AND CLIMATIC REQUIREMENTS

Soil

The crop grows on different soil types, but performs less on very heavy clay and very sandy soils. The crop grows best and gives optimum yield on well- aerated and well- drained loamy soils with pH value of 5 - 7. The crop is susceptible to waterlogging. The roots cannot perform their normal function or survive in waterlogged soils. Maize is moderately sensitive to salinity. The fertility demand of the crop is relatively high, particularly the high yielding hybrid varieties.

The crop is deep- rooted up to 3 m and 80 % of the roots are located in the upper layer of 0.8 to 1.0 m. In general, the crop can be grown continuously as long as the soil fertility is maintained at the optimum level. However, crop rotation with legumes and other short- cycle cereals is advantageous in order to maintain soil fertility and reduce the build up of soil- borne insect pests and plant diseases and minimize crop yield losses that could incurred, due to pests attack.

Temperature

The crop is grown over a wide range of climates ranging from the temperate to the tropics during the period when mean daily temperatures are below 15° C and frost- free period. However, maize thrives best in warm tropical climates provided that moisture supply is adequate during the growing season. Maize requires a fairly high temperature in order to germinate and germination is impossible below 10 °C, while that of wheat and barley, can grow at much lower temperatures. But many varieties of maize at higher temperatures require sufficient moisture to germinate and for normal growth and development. Therefore, for germination the lowest mean daily temperature is about 10 °C, while 18 to 20 °C are considered as optimum.

As it is indicated above, the crop is very sensitive to frost, particularly in the seedling stage but it tolerates hot and dry atmospheric conditions as long as sufficient water is available to the plant

and temperatures are below 45 °C. However, the more optimum temperature range is 24 to 30 °C. At temperatures above 30- 35 °C and a relative humidity of 30 %, pollination is significantly affected and resulted in poor ear fill. The influence of temperature on the length of the growth cycle is considerable. The variety sown at an altitude of 1, 500 m in the tropics will have a much longer growth cycle than the same variety sown at sea level. The growing season is most markedly affected by temperature, when daily mean temperatures are greater than 20 °C, early maturing varieties such as Katumani take up to 80 to 110 days and medium maturing varieties take up to 120 to 150 days to mature, whereas long maturing varieties take up to 165 to 180 days.

Altitude

Maize grows at a wide range of altitudes from 0 to 2400 m above seas level, but best perform at altitudes of 1000 - 2000 m above sea level and depending on temperature and the variety it reaches physiological maturity in about 90- 130 days. Obviously at higher altitudes, particularly above 2 200 m the growing season becomes extended up to 8- 12 months as mean daily temperature is lowered and at the same time seed setting will be critical instead the crop can be grown efficiently as a forage crop. The main maize growing season in Ethiopia is from April through October-November under rainfed condition. However, under irrigation condition in frost free areas maize can be grown at any time of the year.

Rainfall

Maize is an efficient user of water in terms of total dry matter production and it is potentially the highest yielding grain crop of all cereals group. Therefore, for maximum production a medium maturing variety grown for grain requires between 500- 800 mm of water depending on specific climatic conditions of the area. High yielding varieties usually have high water requirements as compared with the short maturing varieties. Maize is a cross-pollinated crop (i.e. 95 %). Therefore, maintaining the moisture regime of the soil and the nutrient status at the optimum, particularly during flowering and grain filling stages is very crucial. Maximum nutrient and water uptake occurs during the periods of flowering and pollination. Pollination is a very critical time and is readily affected by stress. Wilting of maize during this period will cut yields very significantly (20- 50 %).

RECOMMENDED IRRIGATION AGRONOMIC PRACTICES

Land preparation /seedbed preparation

Maize is customarily planted on the land that has been cleared and tilled to incorporate crop residues of the preceding crops, and loosened to an adequate depth (20 to 25 cm). Seedbed preparation further assists to incorporate the applied manures with the soil and to destroy perennial weeds as well. The tillage should leave the soil surface somewhat roughened to facilitate penetration of rainfall and to minimize runoff and erosion losses. On the other hand, tillage has minimal effect on crop yields.

Land preparation is undertaking considering the following factors: the preceding crops, soil types, depth of ploughing layer and weeding problem of the field. Overall, preparing the land prior to sowing has the following aims: (1) To plough the land on the desired depth and frequency to make the field free from weed competition; (2) To prepare a fine seedbed by breaking up clods and loosen the topsoil to create a soil structure that encourages the seedling to emerge rapidly and uniformly and allows the young plants ready access to the vital resources of nutrients, water and aeration; (3)

Land preparation encompasses to incorporate residues remaining from previous crops in order to avoid interference with the new crop and incorporate farmyard manures with soil to enrich the soil fertility status; (4) Land preparation should further aim at shaping the land so that irrigation water can be applied efficiently and drained effectively to avoid waterlogging, involving levelling, preparation of furrows, beds and (5) The finely prepared soil will enhance normal plant growth and rapid root development.

Levelling, smoothing and shaping of the field surface are important activities during land preparation with the aim of creating conducive environment for uniform application and distribution of irrigation water over the irrigated field and obtained increased crop yield. Therefore, land preparation is one of the principal activities of irrigated crop production that needs special consideration, since the final yield of crops depends on the timely and quality performance of such an operation. Of course, frequencies of land preparation and plough depth depend on different factors such as soil type, weed infestation, crops type to be sown, and other climatic factors of the area. In general, in heavy and highly weed infested fields require more frequent ploughing, while in fields of light soils need less frequent. In Ethiopian condition, seedbed preparation methods being used are a wooden plow (see fig. 20 below) using a pair of oxen and digging hoe to loosen the soil to a depth of usually 15- 20 cm. For maize crop an average of 3 ploughings are sufficient and the third or fourth ploughing is usually done which opens the soil, covers the seed, and eliminates already emerged weeds. In this regard, availability of appropriate equipment for timely and quality land preparation is important, if not perfect seedbed preparation may not be possible, particularly if the farming system uses flood or furrow irrigation.



Fig. 22. Land preparation being carried out using traditional plough and draught power

Planting /Sowing

In the traditional system of maize cultivation, farmers plant maize behind the plough without using exact plant spacing. They use a high seed rate (30- 40 kg/ha) for security reasons such as against emergence- insect- wind- hail and drought- damage and to provide fodder for their livestock. Generally, plant stand at emergence is as high as 75,000 plants /ha. Farmers gradually thin out the plants between first and second weeding and the resultant stand at harvest is usually 30,000- 45,000

plants/ha. However, under irrigation conditions, planting density is an important consideration to maintain the optimum plant population per hectare. Plant stand per unit area varies from farm to farm, variety to variety, location to location, and according to cropping patterns. Genotypes with less leaf area per plant require more plants per unit area; shorter plants require narrower rows than taller varieties. As a general rule, plant stand should be higher under high fertility conditions and similarly, under irrigation and slightly lower stands are to be maintained on soils with low fertility and rainfed conditions in order to maintain the required plant population as per the moisture content and fertility status of the soil.

Depending on the type of varieties and seed size the recommended seed rate of maize is in a range of 25 - 30 kg/ha. For large seed sized varieties the seed rate can be taken as 30 kg/ha. Plantings should be made in rows for convenience of weeding and pest control, for ease of irrigation water application and harvesting operations. Therefore, the crop should be planted in rows 0.75 m apart and 0.25- 0.30 m between plants and with this planting distance the estimated plant population will be 48, 000 to 57, 000. On average with this planting distance more than 53, 000 plant population per hectare could be maintained. The depth of sowing varies depending on the soil type and season of cultivation. In this regard, on heavy soils the planting depth is around 5 cm and on well- drained light sandy soils it can be sown as deep as 10 cm. However, under irrigation condition without water stress- planting depth should be kept at minimum in order to initiate early germination and develop further more healthy and stronger plant. Two seeds should be planted in a hole and thinned out later leaving the most vigorous one in each hole.

Advantages of row planting are: maintained the appropriate plant population, it avoids competition for water, nutrients and sunlight and the plant will grow more vigorously, easy for weed control; fertilizer is applied in rows and there is no wastage of fertilizer, the crop efficiently utilizes the applied fertilizer effectively and increased yield and easy for carrying out crop protection activities without significantly affecting the crop.

Weeding /Cultivation

In the traditional system of maize cultivation, farmers plant maize behind the plough without using exact plant spacing. They use a high seed rate (30- 40 kg/ha) for security reasons such as against emergence- insect- wind- hail and drought- damage and to provide fodder for their livestock. Generally, plant stand at emergence is as high as 75,000 plants/ha. Farmers gradually thin out the plants between first and second weeding and the resultant stand at harvest is usually 30,000- 45,000 plants/ha. However, under irrigation conditions, planting density is an important consideration to maintain the optimum plant population per hectare. Plant stand per unit area varies from farm to farm, variety to variety, location to location, and according to cropping patterns. Genotypes with less leaf area per plant require more plants per unit area; shorter plants require narrower rows than taller varieties. As a general rule, plant stand should be higher under high fertility conditions and similarly, under irrigation and slightly lower stands are to be maintained on soils with low fertility and rainfed conditions in order to maintain the required plant population as per the moisture content and fertility status of the soil.

Depending on the type of varieties and seed size the recommended seed rate of maize is in a range of 25 - 30 kg/ha. For large seed sized varieties the seed rate can be taken as 30 kg/ha. Plantings should be made in rows for convenience of weeding and pest control, for ease of irrigation water

application and harvesting operations. Therefore, the crop should be planted in rows 0.75 m apart and 0.25- 0.30 m between plants and with this planting distance the estimated plant population will be 48, 000 to 57, 000. On average with this planting distance more than 53, 000 plant population per hectare could be maintained. The depth of sowing varies depending on the soil type and season of cultivation. In this regard, on heavy soils the planting depth is around 5 cm and on well- drained light sandy soils it can be sown as deep as 10 cm. However, under irrigation condition without water stress- planting depth should be kept at minimum in order to initiate early germination and develop further more healthy and stronger plant. Two seeds should be planted in a hole and thinned out later leaving the most vigorous one in each hole.

Advantages of row planting are: maintained the appropriate plant population, it avoids competition for water, nutrients and sunlight and the plant will grow more vigorously, easy for weed control; fertilizer is applied in rows and there is no wastage of fertilizer, the crop efficiently utilizes the applied fertilizer effectively and increased yield and easy for carrying out crop protection activities without significantly affecting the crop.

Fertilizer application

High yielding potential in maize is closely associated with the responsive nature of the crop to nitrogen and phosphorus fertilizers in combination with the high level of photosynthetic activity in the leaf, due to abundant leaf growth, provided that other inputs and management practices are applied accordingly. Nitrogen interacts positively with plant population, with earliness of sowing, with potential of the variety, with good practice of weed control and moisture supply. It should be remembered that weeds also use fertilizers. Therefore, maize field must be weeded 30-40 days after planting to avoid wasting of fertilizer on growing weeds. If weeds cannot be controlled, then fertilizers should not be applied. It is strongly recommended that apply fertilizers after weeding in order to avoid nutrient loss, being used up by the growing weeds and drainage should also be maintained under waterlogged conditions to improve nutrient uptake by the crop.

Furthermore, it is very important to take into account that neither increased plant population nor high levels of nitrogen fertilizer application will improve yields, where other factors are limiting. Fertilizer application under maize crop can improve utilization of soil water by increasing rooting depth, but the best returns from nitrogen fertilizer are only obtained where water supply either natural or supplemented by irrigation, is adequate for full growth and development of maize plants. Nitrogen requirement of maize, particularly at early vegetative growth stages is very essential. Shortage of nitrogen at these early stages will result in retarded growth and poor development of the plant and consequently reduced yield. However, maximum utilization of nitrogen is observed prior to flowering stage and starting from early milk stage onwards, the utilization of nitrogen will decline. In almost all soils and conditions, nitrogen fertilizer increases not only the yield but also it improves grain protein content /but has little effect on protein quality/ and thus, has a real effect on the nutritive value of maize in the human diet and in that of livestock feed.

Maize takes up nitrogen slowly in the early stages of growth, but the rate of uptake increases rapidly to a maximum before and after tasseling, when it can be over 4 kg/ha per day. Nitrogen is a mobile nutrient. As a principle apply fertilizer when the plants need it most. In particular, nitrogen should be applied in split doses at the peak requirement period of the crop. Therefore, nitrogen fertilizer application is best scheduled in accordance with the pattern of nutrient uptake behavior

of the crop, to avoid serious losses of nutrient by volatilization or leaching and to ensure that nitrogen levels are high in the soil when the crop's demand is high. If nitrogenous fertilizer is in short supply, it should be top-dressed when the maize crop is at knee high (30 cm) crop stage after about a month of sowing and the second is when the crop is at tasseling. But with adequate supply of nitrogen fertilizers it is recommended to apply one third of the full recommended amount of nitrogen at planting as a first application, and then followed by two side dressings at knee- high and the second at tasseling stages.

Phosphorus is also important for maize, since the crop cannot readily take up soil phosphorus in large amount needed for optimum growth and high yield. Phosphorus is required, particularly at the start of early growth, when future productive organs are being developed. Best results from nitrogen fertilizer and other inputs will not be obtained without an adequate supply of phosphorus. Phosphorus is immobile nutrient and, therefore, it should be applied either at the time of planting or before planting of maize. Water- soluble forms of phosphorus fertilizers should be applied under maize. Shortage of P at this particular period resulted in poorly developed cobs and not properly filled grain. Optimum fulfillment of P increased development of the root system, increased drought- resistant nature of the crop, shortened formation of cobs and ripening of grain and the maximum P requirement is at grain filling and ripening stages.

The fertilizer recommendation varies with the soil type and agro- ecological zones. The recommended rates of fertilizer under maize as per the recommendation made by the previous National Fertilizer and Inputs Unit of the former MoA based on the soil colour are 50-100 kg/ha and 100-175 kg/ha of commercial fertilizers in the form of Urea and DAP respectively. It is also advisable to use the recommendation given by EARO for different maize growing areas as 50 - 200 kg/ha and 50 - 225 kg/ha of Urea and DAP respectively in the form of commercial fertilizers. In order to get efficient use of minimal fertilizers, it should either be drilled near the plants or band placed /side dressed along the rows of the crop. Broadcasting of fertilizer should be discouraged. The fertilizer should be covered with the soil as soon as after it has been applied; otherwise more than half of the nitrogen applied will be lost by volatilization.

Water requirements

Maize is an efficient user of water in terms of total dry matter production and it is potentially the highest yielding grain crop of all cereals group. For maximum production a medium maturing varieties grown for grain requires between 500 - 800 mm of water depending on specific climatic conditions of the area. The crop is fairly tolerant to mild water stress during its vegetative period and also during the ripening of the grain. However, it is both very sensitive to water deficit and excess watering during flowering, i.e. tasseling and silking. Indeed, severe water stress during silking may result in almost no grain yield, due to silk drying and ineffective pollination. Water deficit during the yield formation period may lead to reduced yield, due to a reduction in grain size, whereas the water deficit during the ripening period has little effect on grain yield. The crop factor (kc) relating water requirements (ET_m) to reference evapotranspiration (ET_o) for different crop growth stages of grain maize is for the initial stage 0.3- 0.5 (15 to 30 days), the development stage 0.7- 0.85 (30 to 45 days), the mid-season stage 1.05- 1.2 (30 to 45 days), during the late season stage 0.8- 0.9 (10 to 30 days), and at harvest 0.55 0.6. But this should be determined locally.

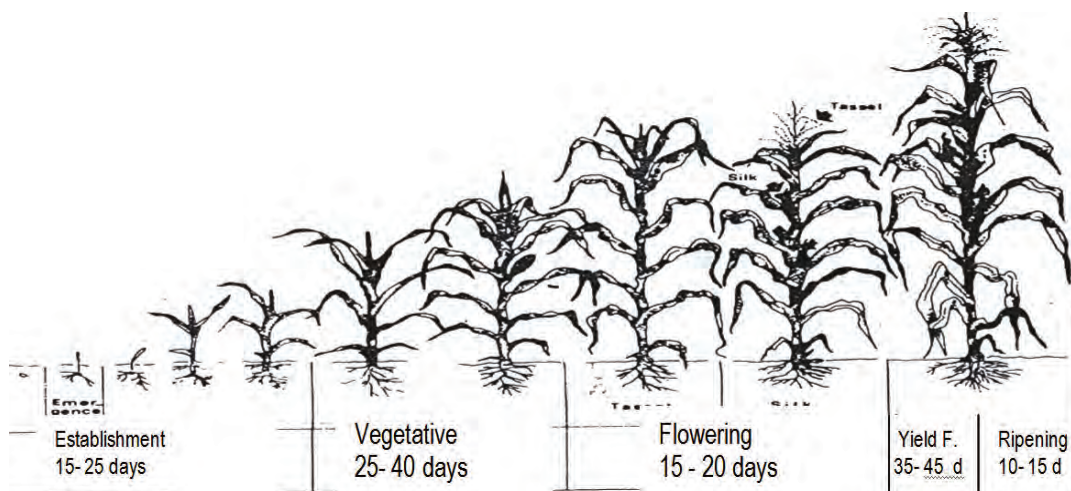

Fig.23. Growing periods of maize (adopted from FAO yield Response to Water)

Irrigation scheduling

In the case of maize, where water supply is limited it is advantageous to meet as far as possible, full water requirements so as to achieve maximum yield from limited area rather than to spread the limited water supply over large area. Soil water depletion up to about 55 % of available soil water has a small effect on yield. Indeed, it is beneficial to allow somewhat greater depletions during the early stages of growth in order to enhance deep rooting. However, depletion of 80 % or more is allowable during the ripening period. If there is adequate supply of irrigation water, intervals of 21 days will be sufficient to ensure good yields. The depth of water that could be applied per irrigation is about 5 cm. In areas, where rainfall is low and irrigation water supply is restricted, then irrigation scheduling should be based on avoiding water deficits during flowering and yield formation periods respectively. When severe water deficit is unavoidable, then it is recommended to save water during vegetative and yield formation periods and be supplied for the crop during flowering period without incurring additional yield loss.

Methods of irrigation

The appropriate and recommended method of irrigation for maize, where substantial water resources and labour forces are available, is the furrow irrigation method. Maize is irrigated by furrow method usually using a spacing of 0.6- 0.8 m. However, in undulated topography and labour shortage, sprinkler irrigation will be the more appropriate one.

CROP PEST CONTROL

Major diseases of maize and their control

The major diseases that attack maize are rust / *Puccinia sorghi*/, leaf blight / *Helminthosporium turcicum*/, head smut / *Sphacelotheca reiliana*/ and downy mildew. The recommended methods of control for the aforementioned diseases are: (1) Using disease free and clean seeds as a seeding

materials; (2) Avoiding excess water from the field; (3) Controlling of weed species that can serve as a host plant around the field edges- field sanitation; (4) Using disease resistant varieties for production; (5) Keeping appropriate crop rotation cycles and (6) Applying appropriate rate of fertilizers.

Insect pest control

Maize stalk borer, armyworms, cutworm, aphids and African bollworm are the major insect pests that cause damage to maize crop. Control methods for each insect-pest are discussed.

Stalk borer

- Destroying of crop residues of maize from previous season.
- Removal and destruction of plants with dead heart symptoms during the first six weeks period.
- Destroying of alternative food sources around the field.
- Applying chemical control when the damage extent level is reached at 5% and putting a pinch of cypermethrin 1 % granule or diazinon 10% inside each leaf funnel of plants, with windowing leaves.

Aphids

- Spray with rogger 40 % E.C 1 litre per hectare by mixing with 200 litres of water.
- Spray perimicarp 50 % W.P 1 kg per hectare by mixing with water.
- Endosulphan 35 % E.C from 1 - 2 lit/hectare by mixing with water.
- Perimiphos methyl 50 % W.P 1 kg/ ha by mixing with water.

African bollworm /ABW/

- Deep ploughing and exposing the eggs and pupae to their natural enemies and unfavourable weather conditions.
- Destroying plants that serve as alternative food sources.
- Spraying with 2 litres per hectare of endosulphan 35 % E.C by mixing with water.
- Endosulphan 25 % U.L.V 3 litres per hectare directly without mixing with water.

Armyworm

The control of armyworm should start immediately when two larvae per plant are observed. The following are the recommended control methods: (1) Applying 2 litres per hectare of malathion 50 % E.C; (2) Spraying 85 % W.P 1.5 kg/ha by mixing with water; (3) Spraying malathion 95 % U.L.V 1.25 or Sumathion / Fenitrothion/ 95 % U.L.V 1.5 l litres per hectare directly without mixing with water; (4) Diazinon 60 % E.C or Fenitrothion 50 % E.C 1 litre per hectare by mixing with water.

Cutworm

- Baiting using trichlorophone 95 % W.P 250g with 25 kg of wheat straw damped with water.
- 2 litres per hectare of endosulphan 35 % E.C by mixing with 200 litres of water.
- Fenitrothion 50 % E.C 1 litre per hectare by mixing with water and spraying in the afternoon hours.

Maturation and Harvest

The maize grain is considered physiologically matured when the kernels reach the “hard dough” stage. The time of physiological maturity is accurately determined by the development of the “black layer” at the point of attachment. Translocation ceases when this black layer forms. At physiological maturity, the kernels still contain about 30- 35 % moisture, which is too wet for spoilage-free storage /except in the form of de-husked ears stored in a crib/. From this stage onward, ripening consists of moisture loss, which may be quite rapid if the weather is dry. If you want to roast the maize cobs, harvest the cobs when the grains are not too ripe. If you want to make flour, harvest the cobs when the grains are quite ripe. Maize kernels should have 10 to 12 % moisture, as the grain will store without molding at this moisture content. If birds or other pests cause serious field damage to ripening maize, the crop may be harvested at the hard dough stage and dried under protected conditions. Subsistence farmers allow maize drying in the field on the stalk before harvesting.

In general, maize yield potential mainly depends on the characteristic of the variety, favourable climatic condition and other management practices. A large ear of maize may have 1000 kernels, but 500- 600 is normal. Any shortage of water, nutrients, or sunlight during the first few weeks of kernel development usually affects the kernels at ear’s tip first, making them shrivel or abort. Most tropical and subtropical maize varieties commonly produce 2- 3 useful ears per plant under good conditions and the most important is the ear and grain size and properly filled up of grains.

Storing maize

Maize cobs can be stored in their husks. That way, the cobs keep better. They can also be stored without their husks, but then insects such as moth weevil may attack the cobs. The greatest hazards to stored maize are: (1) Molding when moisture content is too high; (2) Insect damage - grain weevils, grain moth larvae, and (3) Rodent damage. Grain infesting insects are often brought in from the field at harvest, or they may remain in storage areas from season to season. Storage losses are heavy in warm climates and damage may be serious in relatively short periods. Treatment of the empty storage areas, and treatment of all grain as it enters storage irrespective of apparent infestation, is necessary and relatively inexpensive. Infested empty storage areas and empty containers may be disinfected with a weak solution of Malathion, an insecticide that is rapidly degraded and leaves no toxic residue.

1.2 WHEAT / *Triticum spp.*/

CROP DESCRIPTION AND ITS USE

Wheat was one of the first crops to be domesticated by mankind, and still today it is considered as a major dietary constituent of about a quarter of the world's population. More significantly, the value of the crop has increased gradually in the food supply system throughout the tropics as well. The importance of wheat in the diets of developing countries has grown substantially, and currently it provides 27 % of their cereal calories and 3 % of protein requirements. Wheat crop gained its importance, due to the fact that its flour is unique as it contains high levels of gluten- a protein like substance, when water is added to wheat flour, the gluten proteins bind with water molecules to make the dough easily workable and a light, palatable loaf results. Flours from other cereals and tubers contain little or no gluten and tend to result in a much more dense loaf.

Bread wheat /*Triticum aestivum*/ was first domesticated in the near and Middle East areas / currently occupied by Syria, Turkey, Afghanistan, Iraq and Iran/. Then bread wheat early spread to the European continent and was introduced into other continents by early explorers and colonists. Wheat spreads further in the early times to North Africa and the Mediterranean Region.

In Ethiopia, wheat is among the major cereal crops widely producing in mid and high altitude areas of the country, since ancient times. As a matter of fact, Ethiopia is considered as a centre of origin and centre of diversity, particularly for tetraploid wheat, notably triticum durum, whereas *Triticum aestivum* is considered as recently introduced and currently being widely distributed and being cultivated in the main wheat producing areas of the country. However, almost 55 % of the total estimated area that is covered annually by wheat is covered by *Tr. durum* species. Durum wheat generally, has hard kernel texture and used normally to produce macaroni and similar pasta products, whereas bread wheat varieties may have either hard or soft kernel texture and contain substantial amounts of gluten where under controlled fermentation it rises and form leavened dough that can be baked into bread and other similar products.

Wheat is rich in carbohydrates (70 %) and is primarily an energy food. The crude protein content ranges from 8 to 15 % depending on the type and variety; it is highly digestible, but deficient in several nutritionally essential amino acids, primarily lysine. In milling wheat for flour, the pericarp and the germ are removed from the grain, and since much of the protein and fats are also removed with this portions and the resulting flour has less nutritional values than the whole grain. However, the gluten retained in the flour is sufficient to make bakery products of the desired quality.

VARIETIES

Currently for bread wheat the recommended varieties are K- 6290 bulk, K-6295- 4A, HAR- 1685, HAR- 604 and HAR- 710. Buhie, Foka and Kilinto are also among the recommended varieties of durum wheat. Among the bread wheat varieties pavon is also recommended to be cultivated in lowland areas under secured irrigation /for further details refer Table 26/.

Table 26. Characteristics of wheat varieties and recommended areas for cultivation

Varieties	Altitude (m)	LGP (days)	Plant height (cm)	Seed colour	Seed rate (kg/ha)	Productivity, (qt/ha)		Areas of cultivation
						Research	Farmers' field	
Durum W.								
Buhie	1800- 2500	125	115	Honey type	125- 150	25- 50	20- 40	Adaa, Lomie, Akaki & Chefe
Foka	1800- 2700	130	120	"	"	30- 50	25- 40	Major wheat growing areas
Kilinto	1800- 2700	125	115	"	"	25- 55	25- 45	Adaa, Akaki and Ambo
Bread W.								
K- 6290 bulk	1800- 2200	128- 134	110- 125	Red	125- 150	30- 50	25- 35	-
K- 6295- 4A	1900- 2400	127- 134	100- 115	"	"	35- 55	30- 40	-
HAR- 710	2000- 2500	105- 130	90- 100	White	"	40- 60	25- 40	-
HAR- 1685	2000- 2600	110- 140	90- 100	"	"	50- 70	25- 45	-
HAR- 604	2200- 2800	120- 155	100- 125	"	"	45- 65	25- 40	-
HAR- 1522	2200- 2700	128- 131		"	"	40- 65	na	
Pavon 76	700- 2200	120- 135	90- 125	"	"	30- 60	na	-

Source: Ethiopia Agricultural Research Organization: 1) for durum wheat varieties Debre Zeit ARC, 2) for Bread wheat varieties Kulumsa ARC.

In general, dwarf varieties are highly responsive to irrigation water and fertilizer application. A short, stiff, strong stem is the main advantage that dwarf wheat varieties have over the taller varieties. This shorter stem allows the plant to utilize irrigation water and fertilizer more efficiently without lodging and results in higher yields. White grain color of bread wheat varieties have better acceptance and a better price and similarly, for honey color grain of durum wheat. Therefore, it is advisable to grow adaptable varieties to specific areas with optimum yield potential and have better market values.

SOIL AND CLIMATIC REQUIREMENTS

Soil

The crop can be grown on a wide range of soils but performs best on medium texture soils such as well- drained clay loams, loams and sandy loams. It is also moderately tolerant to soil salinity and relatively can withstand a high ground water table. However, on heavy black soils the crop can be grown on ridges made by broad bed makers or by local means.

Altitude

In Ethiopia the crop is grown widely in mid and high altitudes ranging from 1700 - 2800 m above sea level. But it is more adaptable to a range of 1800 - 2400 m above sea level. However, under irrigation the crop can be grown successfully even below 1700 m above sea level (as per the information obtained from WARC). The length of the total growing period of spring wheat ranges from 120- 150 days.

Temperature

Wheat is sensitive to frost. So that it is strongly recommended that the crop should be grown in frost-free periods. For wheat the minimum daily mean temperature for measurable growth is about 5°C and mean daily temperature for optimum growth and for better tillering capacity is between 15 and 20°C. So that selection of appropriate sowing date is essential. The only economic way to deal with frost in wheat is to ensure that the whole crop is not at sensitive stages when frost is likely to occur. Therefore, planting earlier or adjusting the planting time to escape the frost sensitive period is given paramount importance.

In warm climate areas with high temperatures wheat crop is similarly sensitive to high temperatures, particularly to temperatures higher than 40 °C and the damage is commonly associated with water stress, particularly at seedling, flowering and grain-filling stages. Water-stressed plants attempt to conserve water by closing their stomata. As a consequence evaporative cooling diminishes and, without that cooling effect, leaf temperatures might approach to 50 °C. At such temperatures the whole plant processes breakdown.

In order to avoid significant yield losses as temperature raises, farm management must become more stringent, more-timely and more precise for yields to be maintained particularly water and supply of nutrients at optimum level need special consideration. In warm climate areas the crop grows faster so daily demands on resources are greater and therefore, mulching of seedlings to protect them from high temperature effect is important and at the same time it conserves water by minimizing evaporation rate. Mulching keeps soil temperature down during the day by insulating it from incoming solar radiation and it also reduces soil-cooling effect at nighttime. In addition, sowing as soon as possible after seedbed preparation so that water losses from the freshly turned soil are minimized and at the same time this will allow shallower planting and ensure emerging of plants more rapidly. It is also recommended to select the optimum planting time to avoid high temperature effect during anthesis /flowering/ and grain-filling.

Moisture /rainfall

Wheat is a crop sensitive to water deficit, resulted in yield reduction. In contrast, it does not withstand waterlogging problem for prolonged period. Optimum yield is obtained in areas having an annual average rainfall of 1200 mm and a total amount of 600 mm evenly distributed throughout its growing period is adequate for good harvest.

RECOMMENDED IRRIGATION AGRONOMIC PRACTICES

Land preparation

Preparing the land prior to sowing for wheat crop have the same aims and effect as that of maize. The crop is recommended to grow in rotation with legumes, oil crops and other long cycle cereals such as maize. The land should be ploughed immediately after harvest of the preceding crop, while it is still moist and the soil is loose and easily workable. At this particular time the land is easy to plough and allowed effectively to incorporate crop residues of preceding crops with the soil. This will help to expose the larvae and pupae of insect pests to sunlight and to their natural enemies as a result reduce the pest infestation.

For wheat crop an average of 2– 3 times of land preparation before sowing and once for seed covering are sufficient. However, land preparation should aim at giving time for weed species to germinate and destroying them later during ploughing in order to minimize weed competition of cultivated crop. It is advisable to reduce clods and level the field for ease application of irrigation water. It should also be taken into consideration that the soil should not be worked out when it is too wet or completely dry, since these can create clods and destroys soil structures.

Planting /sowing

There is an optimum sowing time for every location determined primarily by weather, availability of irrigation water at the field level, the variety that is being used and the likely occurrence of diseases or frost damage. The most appropriate time for sowing of wheat under irrigation is just the time that is free of frost and when the irrigation water is available at the field level. Pre- planting irrigation is beneficial in building up soil water reserves to encourage rapid and uniform germination and enhance rapid root development. The recommended spacing is 0.15 to 0.2 m between rows. The recommended seed rates for wheat are usually in a range of 100- 150 kg/ha. However, the average seeding rate of 125 kg/ha is sufficient to plant. Plant numbers in wheat can often vary widely without appreciably affecting yield in irrigated field. This is because wheat plants produce tillers that can produce leaves, spikes and grain. Seed rate is less critical in the case of wheat than other factors that can significantly reduce yield.

The optimum depth of sowing for wheat is 3- 5 cm deep. The correct planting depth is one that places the seed where it can imbibe water for germination but not desiccate thereafter. However, under irrigation condition, having available irrigation water potential- planting depth should be kept at the minimum in order to initiate early germination and develop further more healthy and stronger plant. Shallower planting depth allows plants to germinate rapidly and uniformly, produces stronger and broader leaves and develops more tillers that can increase the final yield of the crop.

Weeding

Wheat is very sensitive to weed competition, particularly annual weeds during the early growth stages /at seedling and tillering stages or 3- 6 leaf stage/. This is approximately between 2 and 4 weeks after emergence. Weeds after this time have less competitive effect but may interfere with harvest and act as a subsequent infestation source. So the early growth stages are very critical periods for weed control. An average yield loss in wheat that has not received any weed control is about 37 %. Grass species and wild oats species in particular are more difficult to control than broad-leaved species in wheat fields, due to difficulties of their distinguishing character during hand weeding. The following are the recommended weed control practices in wheat crop: (1) Use weed- free seeds for sowing; (2) Fulfill the crop requirement to establish early and for normal growth and development, which will dominate further weed growth and competition; (3) Follow appropriate crop rotation practices to avoid same weed species build up each season and leave the land fallow and cultivate after a short period of time between crops; (4) Weed control can be done effective by hand weeding or by the application of herbicides.

Weed control in wheat fields is usually practical by hand weeding or by the application of appropriate herbicides to combat the important weed species, particularly on heavily weed infested fields. Care should be taken during hand weeding in order to avoid the damage of the root system. The root

system is not damaged when the herbicides are properly used. Two or three hand weedings has shown to be the most economic practice and give the best results in most areas of the country. It is recommended that the first hand weeding should be done 2 - 3 weeks after sowing /at early tillering stage/, this is approximately 25 - 30 days after planting and the second hand weeding at 4 - 5 weeks after emergence /55 - 60 days / or at stem elongation stage. The third hand weeding whenever necessary can be conducted just before heading and not recommended after the crop has started to boot, as this will cause too much damage to the crop.

Where the weed problem is very serious and in absence of adequate labour, herbicide application might be the alternative solution. However, great care should be taken to control weeds using herbicides without causing any damage to the crop. Therefore, it is important to look carefully the instruction provided on the labeling. In this case of herbicide use, it will be important to identify the weed before choosing the herbicide and it is not recommended to use the same herbicide year after year. Spraying in the early morning hours after dew is better than late in the afternoon and do not spray if it is raining or about to rain. For effective control of broad weed species 1 liter per hectare of 2,4 - D amine at 5 leaves stage of weed growth mixing with 200 liters of water or mecaprop 2.2 lit/ha at 4 - 6 leaf stage of the crop is recommended to use. For grass weed species grasp 2.5 lit/ha at 2 - leaf stage of the weed or puma super 2 liters/ha at 4 - 5 leaf stage of the crop can be applied all are as post- emergence herbicides.

Fertilizer application

Fertilizer application for wheat in general plays an important role, particularly under irrigated condition. The key fertilizer nutrient for optimum yield of wheat is nitrogen and its role in the physiological process of wheat is similar to that of maize. However, nitrogen in wheat increases the protein content of grain, which improves the bread- making quality of wheat, because flour from high- protein of grain makes a loaf of better texture and appearance. The principal factors that determine the optimum rate of nitrogen fertilizer under wheat are: the yield potential and height of the variety- short strawed and high yielding varieties are highly responsive, whereas tall or local varieties often respond less; adequate water supply is very crucial to respond to high rates of fertilizer and soil nitrogen supply from the previous cropping or application of organic manure reduces nitrogen fertilizer requirement. Therefore, farmyard manure could be added if available as this contains most micro and macro- nutrients and incorporate stubble from previous crop to build up organic matter and improve aeration or incorporate green manures to improve soil fertility.

Timing of nitrogen fertilizer application is influenced by phasing of crop demand and by the need to minimize losses through volatilization and leaching. Most wheat varieties will respond to a small amount of nitrogen fertilizer application at sowing, but where moderate and high rates are used the main application should be at the beginning of the rapid growth and development growth stages that are from mid tillering through spike development, sometimes two or three top dressing can be justified. Application of nitrogen at or shortly after ear emergence can help to raise grain protein content and improve bread- making quality. It is important to note that under irrigation condition, it is recommended to apply the nitrogen fertilizer in a split application particularly that of nitrogen and always top- dress fertilizer just before irrigation water is applied.

Phosphorus is an important nutrient for wheat, though yield responses are usually smaller than to

nitrogen. The requirement for phosphorus is often high on soils newly brought into cultivation or with only short cropping history. It can also be especially important in low rainfall areas. In such conditions placement of phosphorus fertilizer with or near the seed is beneficial. In intensified agriculture there is a great need for application of phosphorus fertilizer both to support the crop need and to maintain soil fertility by replacing the amount of phosphorus removed with the yield.

The recommended rates of fertilizer for wheat crop under irrigation is 100 kg/ha of DAP and 100 kg/ha of Urea, like that of the rainfed crop, since there is recommendation under irrigation. It is also advisable to use specific area recommendations, whenever available. For example, for bread wheat around Arsi on red and light soils it is recommended to use 125 kg/ha of DAP and 75 kg/ha of Urea and on heavy soils 100 kg/ha of DAP and 100 kg/ha of Urea are recommended. Similarly for durum wheat around Debre Zeit area it is recommended to use on heavy clay soils 110 kg/ha of Urea and 50 kg/ha of DAP, while for other soil types 60 kg/ha of Urea and 100 kg/ha of DAP can be used as recommended by the respective research centres.

Water requirements

For high yields the water requirement varies from 450- 650 mm depending on the climate and duration of the growing period. In this regard, for most varieties and notably for those high yielding varieties of wheat, pre- planting irrigation at a depth of 10- 15 cm is beneficial to improve the soil moisture conditions for good and uniform germination and rapid root development to maintain optimum plant densities for optimum yields. The flowering period is the most critical stage in terms of sensitivity to water stress and followed by early crown root initiation stage, since the crown root development and growth affect tillers formation that have great role for final yield formation. The loss in yield due to water stress at this time of growth stage cannot be recovered by providing sufficient amount of irrigation water during the later growth periods. Pollen formation and fertilization can be seriously affected under heavy water stress, which further reduce number of heads per plant, head length and number of grains per head. So that it will be very important to avoid water stress from flowering stage up to early dough stage, since this can greatly affect the final yield. It will also be vital to discontinue irrigation thereafter in order to avoid non- uniform and delayed maturity.

Wheat deteriorates rapidly in waterlogged soils, particularly if temperatures are high, since oxygen is insufficient and root nutrient uptake and development is significantly affected. In addition, due to stomata closing photosynthesis preventing and soil denitrification commences. This will further lead the plant not able to absorb the nitrogen from the soil, instead it will start extracting from the old leaves to the young growing plant parts and as a consequence old leaves will become nitrogen deficient and becoming yellowish during a period of waterlogging. This greatly affects the tillering capacity of the plant and finally affects the yield. Therefore, waterlogging should be avoided using appropriate draining systems and at the same time it is recommended that in waterlogged areas apply nitrogen after a period of waterlogging, keep the field free of weeds in order to avoid competition for oxygen, consider light cultivation if crusting occurs, use raised bed system for waterlogged prone areas, avoid hard pans to improve the water infiltration capacity of the soil and apply green manures to improve the organic matter and improve the soil structure.

Irrigation scheduling

Sometimes it is advisable for irrigation scheduling guided by physiological stages of the crop as one of the most appropriate and ease for application to farmers under Ethiopian conditions. In areas, where rainfall is low and the supply of irrigation water is limited irrigation water should be scheduled to avoid water stress during the flowering period in order to increase the kernel weight and consequently the yield. Where possible a heavy pre-planting irrigation is extremely important. At the same time it is also important to avoid over watering the crop in the vegetative period as this results in increased vegetative growth, which can lead to lodging and delayed maturity. In dry and windy areas, it is not advisable to irrigate the field at day hours, instead, it will be important to irrigate in the morning and late afternoon hours, when the wind is relatively calm and evapotranspiration rate is less in order to avoid lodging and minimize water loss. Since, irrigating during windy hours can increase lodging that can affect greatly the yield, it is recommended to grow short varieties in areas with high winds, particularly during the later stages of growth. The water uptake of wheat is related to the density of roots and their normal development and 50 - 60 % of the total water uptake takes place in the first active rooting depth of 0.6 m and the rest 20 - 30 % in different directions

Irrigation methods

Wheat is irrigated by surface methods, principally using border strips and furrows irrigation methods.

CROP PEST CONTROL

Disease control

Even though there is no data that can confirm incidence of major diseases of wheat under irrigation in Ethiopian condition, wheat is exposed to different leaf, stem and spike diseases. Among others stem rust, leaf rust, yellow rust and septoria are the major ones. However, most of these diseases are very serious when the temperature is low and the air is humid, which are favorable conditions for the spreading of diseases. Recommended control measures are: (1) Follow appropriate crop rotation cycle /rotating wheat crop with legumes and oil crops/; (2) Maintain appropriate seeding rates and fertilizer application rates; (3) Drain out excess water from the field; (4) Avoid weeds of close related species that can serve as host plants and (5) Use disease free seeds or seeds of resistant varieties.

Control of insect pests

Among major insect pests that attack wheat in the field are armyworm, Russian wheat aphids /RWA/, Wollo bush cricket /WBC/, grasshopper, shoot fly, whereas weevils and rats are the major storage pests of wheat. Grasshopper and WBC could be controlled by: (1) Deep ploughing immediately after harvest is beneficial in order to expose the larvae and pupae for unfavourable weather conditions and for their natural enemies to reduce their population; (2) Early and simultaneous planting in the same locality are advised; (3) Avoid alternative host plants in the field edges that can be used as food sources and then transferring further to the main field when

the crop reaches its susceptible stages; (4) Provision of campaign to collect and kill hoppers with a bunch of shrubs at morning hours when the pests are inactive and in having sunshine heat; (5) If control is not effective using the above recommended control options, apply the following:

- Spraying carbaryl 85 % W.P 1.5 kg/ha by mixing with 200 liters of water;
- Spraying malathion 50 % E.C 2 lit/ha by mixing with 200 liters of water;
- Spraying fenitrothion 50 % E.C 2 lit/ha by mixing with 200 liters of water;
- Spraying fenitrothion 95 % U.L.V 750 ml/ha without mixing with water;
- Putting a bait prepared using bendiocarp 1 % dust 300 g or propacksur 2 % dust 250 g mixing with 10 - 12 kg of wheat straw slightly wetted with water spreading in the field.

For the control of armyworm and aphids, refer to the control options recommended under maize production.

HARVEST

Most of the varieties of wheat matured within 120 - 150 days. The wheat crop usually ripens about 30 days after blooming of the florets. The kernels are completely filled when they reach the dough stage, at which time the leaves, stalks and the spikes begin to lose green colour and become golden yellow. From this stage onward, ripening consists of gradual loss of moisture content of the grain /kernels/. When completely air-dried, the kernels will average about 10 to 12% moisture, at which time they may be stored safely without molding. Therefore, yellowish or whitish color of the leaves, stalk and spikes is the symptom of maturity of the crop. It is, therefore, strongly advisable to harvest the crop just immediately after the leaves, stalk and spikes colour turns to yellowish or whitish, in order to avoid shattering and reduce yield reduction.

Harvesting may be done by hand with sickles as usually practiced by most of the Ethiopian farmers or with machines. It is also essential to pile up the harvested product properly and thresh timely on a well-prepared threshing ground, watered and plastered with a mixture of cow dung and mud in order to keep the quality of the produce. The threshing activity is usually carried out by animal power. However, threshing can be carried out using either small hand operating threshers or combiners too. Combine harvesting and threshing of standing crop by use of machines is practical in areas where machine harvesting is well introduced and large areas are expected to be harvested, but the grain must be thoroughly dry before such harvest.

Storage and storage pest control

The grain should be cleaned and stored in clean storage facilities in order to avoid further yield loss due to storage pests. Therefore, the first requirement for safe storage of wheat in the tropics, like Ethiopia, is to keep the grain dried to 10 % moisture or less before storing. For higher moisture content of wheat grain, additional drying is required to prevent from spoilage due to molding. Protection of stored grain from storage insect pests and rodents is particularly important in the tropics and sub-tropics. The protection activities of grain must begin with treatment of on-farm storage structures and containers to destroy insects hidden in these storage structures from previous harvest, but initial treatment of the grain as it enters storage is equally important. The

greatest hazards to stored wheat and similarly of maize grain are: (1) Molding when the moisture content of the stored grains is too high; (2) Insect- pest damage such as grain weevils and the like; (3) Damage, due to rodent pest attack.

Storage losses are heavy in warm climates and damage may be serious in relatively short periods. Treatment of the empty storage areas, and treatment of all grain as it enters storage irrespective of apparent infestation, is necessary and relatively inexpensive. Infested empty storage areas and containers may be disinfected with a weak solution of malathion, an insecticide that is rapidly degraded and leaves no toxic residue. A widely used insecticide for grain treatment at farmers' level is actelic 2 % dust with the recommended rates of 50g/100 kg of grain before infestation and 100g/100 kg of grain for infested grain.

2. OILSEEDS

2.1 Groundnut /*Arachis hypogaea*/

CROP DESCRIPTION AND ITS USE

Groundnut /peanut/ is botanically a member of the largest and most important group of the leguminous plants. But it is mainly being produced for its oil worldwide and categorized under oilseed crops. It is a major cash crop and widely grown in the tropics and subtropical regions of the world for direct use as food, oil and high protein meal. This important oil seed crop originated from South America, particularly from the country recently known as Bolivia. Major groundnut producing countries of the World are China, India, Nigeria, Sudan, Senegal, USA, Argentina, and Brazil.

The crop in Ethiopia is becoming important both for home consumption and local market. In major producing areas of the country it is considered as a cash- generating crop. In Ethiopia the annual area coverage of groundnut is estimated to be about 40, 000 ha and the main producing areas are mainly concentrated in the mid and lowland areas of eastern, western and north western parts of the country. Average yields of groundnuts in shells are about 8 qt./ha, characteristically common for other African countries too. The shells make up 30 % of the weight. The farmers are cultivating the crop principally as a cash crop and secondly for soil nutrient improvement, since the crop has an ability to trap the molecular form of nitrogen from the surrounding atmosphere and in association with the root nodule bacteria can convert to nitrate forms and enrich the soil that could be available and utilized by the proceeding crop.

The seed of groundnut is very rich in oil content and it contains about 44 – 56 % of oil, 25 – 35 % of protein and 18 % of carbohydrate sources. The residual cake after extracted the oil is also a valuable livestock feed containing over 45 % of protein, therefore, it can be considered as a supplementary source of protein for animal feeding. The oil can be utilized for food processing industries, for soap, perfume manufacturing and for medicinal preparation. It can also be used in roasted form and the stems are used for cattle feeding. Moreover, groundnut plays an important role in export marketing and for earning of foreign exchange.

VARIETIES

There are two types of groundnut varieties: (1) The Spanish- Valencia type in which the plant is generally erect, bunch type, matures early, has pods clustered about the base of the plant and the seeds possess little fresh dormancy period and (2) The Virginia type in which plants are spreading /running/ to upright (bunch), in growing habit, have pods dispersed along the secondary and tertiary branches, and the seed possess appreciable fresh dormancy. The recommended varieties for production are: NC 4X, Shulamit, Betisedi (ICG- 273), NC- 343, Bulki- 01, Roba- 7794, Werer- 963 and Werer- 964. Shulamit, NC 4X, Werer- 961 and Werer- 962 are Spanish Valencia type in their growth habit, while the others are Virginia type. The variety Roba- 7794 is adopted from the International Groundnut Improvement Centre and the seed size, colour and taste has the desired quality and acceptable in the market. Detail characteristics of each variety are indicated in Table 27.

Table 27. Characteristics of groundnut varieties and recommended areas for cultivation

Varieties	Altitude ranges (m)	Oil content (%)	LGP (days)	Seed rate (kg/ha)	Productivity (qt/ha)	Seed colour	Recommended areas of cultivation
Shulamith	750- 1650	44	140- 160	80	20- 35 (50- 67)*	Light Yellow	Mid and lowland areas
NC 4X	750- 1650	46	140- 160	80	20- 40 (50- 70)	Light red	Middle Awash
NC- 343	750- 1650	48	140- 160	80	20- 30 (40- 60)	Opaque red	Mid and lowland areas
Bulqi- 01	1000- 1650	53	136- 140	80	12- 22 (60- 65)	Light red	"
Roba- 7794	550- 1650	49	140- 160	80	30- 35 (50- 70)	"	Dedesa, Abobo, Fincha
Betisedi / ICG- 273	750- 1900	52	90- 120	80	10- 20 (25- 40)	"	Wolenchiti, Meiso, and Sidama
Werer- 961	750- 1650	45.72	127	70	27	"	Gofa, Babile, Werer, and Selamber
Werer- 962	750- 1650	47.80	130	100	29	"	Gofa, Babile, Werer, and Selamber
Werer- 963	1400- 1650	45.86	129	80	22	"	Meiso, Babile, Kobo & similar moisture deficit areas
Werer- 964	1400- 1650	46.16	128	80	21	"	Meiso, Babile, Kobo & similar moisture deficit areas

NB: * - Figures in parenthesis indicate the productivity level of the crop under irrigation condition (source: Werer Agricultural Research Centre).

SOIL AND CLIMATIC REQUIREMENTS

Soil

Soil type and condition is highly important for groundnut production. The crop is best adapted to well- drained, friable, medium textured soils that are loose to allow the pegs to enter the soil easily and lifting of the crop at the time of harvest will be easy. Well- drained sandy loams are best for production of the crop. The pod develops only under the soil surface, and thus, it is quite important that the soil be sufficiently friable for the “pegs” to penetrate easily. Heavy soils can be suitable for good crop performance, but harvesting of the crop will be difficult and the pods will remain in the soil, which will affect ultimately the crop yield. Groundnuts don't tolerate poor drainage but do grow well in acid soils and even they can tolerate acidic soils up to pH 4.8. Soils that crust or cake are unsuitable, since penetration of the pegs is hindered. The ideal pH range is between 6- 8 / pH of 5.5 is optimum/. The crop is moderately sensitive to salinity and yield decrease with the increase of soil salinity levels.

Altitude

Groundnuts have good drought resistance and heat tolerance nature and considered as one of the lowland oil crops and best growing in hot and warm climates below 1600 m above sea level / especially well adapted to the semi-arid tropics/. The total growing period of the crop is 90 - 115 days for sequential branched varieties and 120 - 140 days for alternately branched varieties.

Temperature

The groundnut is an annual herbaceous legume and a warm- season plant, which needs high temperatures and a warm climate for its germination and normal growth. Groundnut does not tolerate low temperatures and can be killed by frost. The crop is best growing in warm climate areas, and prefers hot, dry weather during seed ripening. Groundnut is a light loving crop. Seeds are starting to germinate at 12 °C. Young seedlings are very susceptible to frost attack. The mean daily temperature for optimum growth is 25 to 28°C, a reduction of yield occurs above 33 °C and below 18 °C. Below 12 °C temperature pods are not formed. Groundnut is also considered a day-neutral plant and day length is not a critical factor that influencing yield.

Moisture /rainfall

As it is indicated earlier groundnut is a warm climate crop and depending on the climatic conditions of the area the crop is best grown with moderate rainfall of 500- 700 mm or with the support of irrigation during the growing season. The crop is particularly sensitive to water deficit starting from flowering to end of pod formation. Shortage of water at this particular crop growth stage will affect flowering and resulted in reduced yield. But from sowing up to flowering the moisture requirement is less and can better withstand drought. During ripening period the crop water requirement will decline.

RECOMMENDED IRRIGATION AGRONOMIC PRACTICES

Land preparation

The land should be well prepared and leveled for ease of irrigation water application and at the same time for uniform germination and rapid root development. The land is cultivated 2 - 3 times in a depth of 25 - 30 cm. During land preparation crop residues should be incorporated into the soil. After leveling the field it is necessary to prepare a ridge spacing 60 - 80 cm apart for irrigation water channeling.

Planting /sowing

Row planting is highly recommended for ease of irrigation water application, placement of fertilizers and for weed control. Then the crop is planted in rows with spacing of 60 to 75 cm between rows and 10 to 15 cm between plants and the average depth of sowing is about 5 cm deep. Seed rates vary depending on the soil type and varietal characteristics and a range of 60- 80 kg/ha of unshelled seeds /or 20 - 40 kg/ha of shelled seeds/ is recommended to use /a reduced amount of seed rate is advisable for erected type of varieties/. Either shelled or unshelled seed may be used as a seeding material, but if unshelled seed is planted, the pods must be broken into two or more pieces to give prompt germination.

Weeding /cultivation

Groundnuts are susceptible to early weed competition starting from the early vegetative stages of growth, particularly during the growth periods before the crop canopy is well established because of their initial slow growth habit. Groundnut is, particularly very sensitive to Cyprus species, which greatly reduce its yield, unless and otherwise controlled effectively and timely. They are also sensitive to weed interference during pegging. Therefore, under irrigation conditions, three hand weeding are essential to reduce competition from weeds before the crop is well established and thereby suppressing further the weed growth.

The first hand weeding will then take place after 30 days of sowing, while the second 40- 50 days after planting and the third between 60- 80 days after emergence. In addition, it is recommended to continue weeding and earthen up the root whenever necessary till the crop canopy is well established. Particularly, at flowering period it is important to use shallow cultivations between inter- row areas to loose the soil for ease of penetration of the pegs into the soil and care should be taken not to damage the roots while cultivating. However, during pod formation under no circumstances should the crop be disturbed through weeding or shallow inter- row cultivation, since this may interfere with pegging and eventually this will affect the yield. Therefore, do not cultivate after 50 % of the plant has flowered, since this will damage developing pods.

Fertilizer application

Groundnut is not very demanding in terms of fertilizer use like other legume crops, most of the nitrogen requirement of a groundnut crop is provided by fixation in the root nodules by symbiotic Rhizobium bacteria. However, a minimum application of nitrogen fertilizer at planting time is

essential for early plant growth until the nodules of bacteria are fully established. In most cases, particularly in areas, with predominated cereal cropping pattern, inoculation of the seed with a Rhizobia strain is essential. Groundnut needs phosphorus fertilizer for optimum yield and also for optimum development of nodules and Rhizobial nitrogen fixation.

Groundnut is best growing in rotation with crops such as wheat, maize and sesame, particularly following crops that have been well fertilized. The groundnut apparently utilizes rather well the residual mineral fertilizers left from the preceding crops. The root system is well nodulated, and the plant is, therefore, not dependent on soil nitrogen nor on mineral fertilizers to meet its high nitrogen requirements. However, there should be an adequate supply of calcium in the soil to prevent the formation of blind empty pods, which could be supplied from the soil to some extent. As a general guide, DAP at a rate of 100 kg/ha is recommended to use. But among the major producing areas, Haraghie, Sidamo, Bale and around Melka Werer the application of fertilizer is not responsive, therefore, in those areas it is better to grow the crop without fertilizer (Werer Agricultural Research Centre). The more appropriate method of application of the recommended fertilizer is placing the fertilizer in bands below the seed and covers with 5 to 8 cm thickness of soil, and places the seed thereon, and finally there is a need to cover the seed with about 5 cm of soil.

Water requirements

Depending on the climate, the crop water requirements are between 500 and 700 mm for the total growing period. Excessive water application either through rainfall or irrigation limits the activity of N-fixing bacteria, due of lack of oxygen. Excess watering, particularly in heavy soils approaching the harvest time can cause the pods to be torn easily and the pegs remaining in the soil. The flowering period is most sensitive to moisture stress, followed by yield formation, particularly the early part of yield formation period /pod setting/. In general, water deficits during the vegetative period cause delayed flowering and harvest and reduced growth and yield. Water deficits during flowering cause flower drop or impaired pollination, whereas water deficits during the yield formation period give a reduced pod weight and oil content. In the case of limited water supply, water savings should be made during periods of vegetative growth and ripening and be supplied at flowering and early yield formation periods.

In the case of groundnut it is possible to increase production by increasing the cultivated area and partially meet the crop water requirements rather than by meeting full crop water requirements over a limited area. Since the crop has a well developed taproot system with numerous lateral roots extending often to nearly 2 m in depth in which gives the plant a possibility to uptake water from deep soil layers. However, the major part of the root system is found in the first 0.5 to 0.6 m of soil layer. Given an evapotranspiration rate of around 5 mm/day, the uptake of soil water by the crop begins to decrease when some 50 % of the total available soil moisture has been depleted. Therefore, the maximum yield of groundnut could be obtained when it is irrigated at 60 % of soil water availability.

Irrigation scheduling and methods

Depending on the level of crop evapotranspiration and water-holding capacity of the soil, irrigation intervals vary from 6 to 14 days up to 21 days for loam soils, with shorter intervals during flowering

and early yield formation periods when depletion of available soil water should not exceed 40 %. In the case of supplemental irrigation, best results are obtained when water is applied during the flowering period. As indicated earlier water stress during the flowering and yield formation periods soundly affect the overall yield potential of the crop and the quality of the produce, such as the oil content of the seeds. Furrow irrigation method is the most commonly used and best-suited method for groundnut. The ridges should be flat topped and not too deep.

CROP PEST CONTROL

Disease control

Major diseases of groundnut are rust, leaf spot, southern blight, and viral and bacterial wilt. The recommended control methods are: (1) fine seedbed preparation and incorporation of crop residue; (2) establish appropriate crop rotation cycle with stalk and vegetable crops; (3) removal of all plant refuse promptly after harvest; (4) avoid related species that can serve as alternative host; (5) use disease resistant varieties; (6) avoid regions and seasons for groundnut production with frequent rains and high air humidity, since these are favorable conditions for the occurrence and spread of diseases; (7) drain out excess water from the field by preparing raised seedbed; (8) avoid damping of soils on the stems during cultivation.

Insect pest control

ABW, aphids and beetles are among major insect pests that attack groundnut in the field. The recommended options are: (1) Early planting; (2) Removal of vines and trash from the field after harvest; (3) Practicing closed seasons or rotation of crops is critically important; (4) Chemical control options under groundnut are not appreciated or if forced to use it should be applied with great care in order to avoid toxic residues in the seed and the vine. It is better not to use insecticides under groundnut in order to avoid toxic residues in the seed and vines. For the control of ABW and aphids, it is advised to refer to recommendations made under maize and wheat.

HARVEST

Harvesting is a crucial activity in groundnut production. The crop is considered ripe when the seeds are fully developed with seed coat showing natural color of the variety, and when the inside part of the shell begun to color. The fruits don't all mature at once, because flowering occurs over 30-40 days and reach maturity about 60 days after flowering. Harvesting can't be delayed until all the pods have matured or heavy losses will result from pod detachment from pegs and from premature sprouting in the Spanish and Valencia types. Groundnuts shrink badly when harvested too early. Since the pods of the crop are below ground level, they must be lifted out without removing the pods from the vine. This is more easily done on sandy loam soils in friable condition. The main root must be broken, and the entire vine with attached pods lifted, either by hand tools or machines. The lifted plants may be cured in a window, with pods not exposed directly to the sun; except in more humid regions or seasons, they may be shocks or small stacks around poles to minimize contact with the soil. Curing continues until moisture content of the seeds falls to 10 % or less.

Groundnut curing is particularly important; in order to minimize the hazard of molding that

produces a toxin /aflatoxin/, which makes the crop unsafe for use as food for man and for livestock feed. The crop rarely suffers from any significant molding until lifted out of the ground on well- drained soils. Prompt and thorough drying of lifted plants prevents molding of the seeds. The presence of molding makes the crop unmarketable, and unsafe for home consumption as food. Wind rows or small piles of vines and pods must be turned over regularly in order to dry the seeds, particularly when rain occurs during the curing stage. Feasible yields for small farmers using good management are in the range of 1700- 3000 kg/ha, depending on rainfall amount and distribution or applying adequate moisture through irrigation. Pods are removed easily from the vines when dried to the stage that the slender attachments are brittle. This is usually done by hand in Ethiopian farmers' condition. If there is any doubt that the seeds are not sufficiently dry for safe storage, they should be placed in shallow layers on drying floors, and turned frequently, until thoroughly cured. Molding at this stage is just as serious as molding during the field curing.

Groundnut stores safely when moisture content of the nuts is brought down to about 10 %, and the relative humidity of the storage room is about 60 %. If there is evidence of any storage insect infestations, the crop should be fumigated promptly. However, it is very important not to treat with poisonous insecticides, in order to avoid any toxicity effects on human and livestock. The most common method of preparing groundnut for human consumption is dry roasting until the nuts develop a light brown color. For oil extraction, the nuts are shelled, cleaned, and crushed into a pulp to open the oil cells as much as possible. For commercial oil extraction, the pulp goes to a cooker where the material is heated to about 110°C in humid atmosphere for 90 minutes. The oil is most commonly extracted by the hydraulic press plate method under a pressure of about 1900 kilos. A less sophisticated home-processing method is cold pressing of the roasted groundnuts, but the oil yield is necessary much lower. In commercial extraction, a metric ton of unshelled / roasted/ nuts may produce 265 kg of oil, 410 kg of meal, and 325 kg of shells.



Fig. 24. Matured groundnut ready for harvest

3. VEGETABLES

ECONOMIC IMPORTANCE OF VEGETABLE CROPS

Vegetables are considered among the major crops that have high economic value and play a very significant role in the daily diet of human being. In this regard, vegetables make several important contributions to tropical diets: (1) Enrich the diet with nutrients, particularly with vitamins and minerals; (2) Render the staple food more palatable and hence improve the intake; (3) Protect our bodies from diseases and other injuries; (4) They are sources of energy and carbohydrates for our body; (5) Improve digestion process because of their high fiber content and (6) They contributed much for marketing to earn additional income for growers. In addition, vegetables have non-monetary values. It can be considered as fiscal fitness exercise to our body, which has significant role to our health and maintaining the right body posture. In addition, it can bring mental satisfaction and rest to our mind. In addition, vegetable production provides raw materials to the processing industries, and plays an important role in improving the diet of each household and give opportunities to produce marketable qualities and quantities both for local and export markets.

The addition of vitamins, minerals, and other nutrients to the diet is the most important factor showing the importance of vegetables for human diet. In fact, vegetables and fruits are significant sources of vitamins A, C, and B and the mineral iron. Of the vitamins, carotene (vitamin A) and vitamin C are the most important vitamins for maintaining human health. Carotene is deficient nearly everywhere in the tropics, with the exception of West Africa where red palm oil is used in food preparation process. Vegetables, whose edible parts are deep green, deep yellow or deep orange, are good sources of vitamin A. In leafy vegetables, a deep green leaf color, which is high in vitamin A, is highly correlated with leaf exposure to sunlight. That's why cabbage and head lettuce are much lower in vitamin A, since the exposure of all plants part to sunlight is reduced. Vitamin C availability in vegetables is found only in growing plants, not in seeds or grains and that high temperatures and exposure to oxygen destroy it. Therefore, cooking vegetables in water for long periods of time destroys its vitamin C content.

The protein content of vegetables is generally low and therefore, a bulk of greens should have to be consumed in order to meet daily requirement of protein, some greens like spinach and cassava leaves contain over 25 percent protein on a dry weight basis. Many of the local varieties of green beans commonly eaten in the tropics are considered as important sources of protein for the population. In addition, it should be noted that a high intake of fibre effectively prevents constipation and digestive problems. The important minerals such as calcium and iron are often lacking in diets in the tropics. Calcium deficiency may occur more frequently if the basic food consists mainly of cereals. A high iron intake is important to avoid problem of anemia that can be occurred very frequently, due to malaria, bilharzia, and intestinary parasites attack. Pulses such as cowpea are rich in calcium and iron.

Ethiopia has suitable agro-climatic conditions, which are favourable to produce vegetables and fruits throughout the year both in the highlands and lowland areas. Among the major vegetable crops being produced in Ethiopia under subsistence farmers and small-scale private companies, including the state farms include tomatoes, onions, cabbages, green peppers and potatoes. However, fruit production is low as compared to vegetable crops both in terms of area coverage and volume

of produced. Within the group of fruits, banana is the most common fruit crop being produced (Ethio-Netherlands Horticulture Partnership, draft mission report, 2007). The main fruits being produced and exported are bananas, citrus, grapefruit, mangoes, papaya and avocados and the main export markets for fruits are Djibouti, Saudi Arabia, Yemen and Sudan. However, the majority of citrus production is still largely confined to state farms, but the productivity of their orchards is declining, due to poor management practices. Similarly, the production of mangoes is to a large extent scattered and not followed the recommended crop management practices. The varieties widely grown and the quality of produce are not maintaining the desired quality. However, in this manual emphasis is mainly given to selected vegetables and limited fruit crops such as banana.

3.1 GUIDING PRINCIPLES AND PRACTICES FOR SUCCESSFUL VEGETABLE GROWING

Vegetables can be grown over a wide range of soils and of climatic conditions in Ethiopia. Success in growing them, like other crops is basically based on two main principles, the first to maintain favourable conditions with regard to applying improved crop management practices for normal growth and development of the crop and the second to keep the plants free from diseases and insect pests and ultimately increased crop yields and quality of produce. Vegetables like fruits have a special place in the farming system because of the intensive nature of production. Vegetables can give high yields per unit area of land as compared to cereals and hence they generate high income for the farmers and producers because of high market value and profitability nature of the crops. Vegetables like fruit crops require intensive cultural practices and the financial and labour inputs involved are therefore, greater than those required for most staple food crops. Due to these factors and the perishable nature of most vegetables, it is apparent that the vegetable garden must be carefully planned. Therefore, in the planning phase it will be important to collect relevant data regarding soil, climate and other socio-economic parameters of the area and analyzed thoroughly. Then based on the data collected and analyzed, it will be important to come up with appropriate recommendations of the planned activities.

Therefore, selection of suitable soils, determining appropriate climatic conditions, selection of appropriate crop varieties, methods of production system, planting method, pruning, cultivating, fertilizing /manuring, water requirements of crops and its efficient application and protection of crops from diseases and insect pests attack, are important factors that need prime consideration in successful vegetable growing. In general terms warm season vegetables such as tomato, pepper, water melon, cucumber and the like are grown in the lowland areas, where irrigation water is available; whereas cool season vegetables such as cabbage, carrot, beet root, garlic, kale, Swiss Chard and the like are grown in cool climatic areas both under rainfed and irrigation conditions in homestead and commercial farms both for domestic use and export markets. Further details of each consideration are discussed as follows.

Climatic conditions

Rainfall, temperature, incidence and danger of frost in the area, prevailing winds, solar radiation and relative humidity are important climatic data that should be gathered, since these data are

important to select crops, crop varieties and the growing season and determine intensity of cropping. The altitude must also be known, since there is a close relation between altitude and climate. For successful vegetable growing the following factors, which affect significantly crop growth and ultimately the final crop yields should be considered.

a) Rainfall

Both the annual rainfall amount and the monthly distribution should be considered carefully in selecting the appropriate site for vegetable growing. Many vegetable crops are sensitive to excessive water in the active root zone and the pattern is, therefore, likely to determine the range of crops, which can be grown. Particularly during the dry season availability of irrigation water is the very crucial issue to grow vegetables, since these crops are high in their water requirements.

b) Temperature

It is another major factor affecting growth of many vegetables, but one, which cannot easily be modified in any practical manner. Frost-free periods should be considered, since many vegetable crops are susceptible to frost damage. Those crops, which are sensitive or tolerant to high or low temperature, should be selected for the local prevailing conditions.

c) Topography and altitude

Topography and altitude of an area is important in relation to temperature and temperature fluctuation. The principal factors are the slope of the land, its exposure to wind and soil erosion, liability to frost hazard and effectiveness of the natural drainage system. Day- night temperature variations, which occurs over 1, 000 m is beneficial to many crops, particularly leafy crops such as brassicas spp. and onions. For successful vegetable growing, areas with minimum slopes or fairly level flat sites are preferable. Since the site is fairly level the land will be easier to work and irrigate and not susceptible to soil erosion. In this case, land leveling is not critical. In addition, with topography variations there will be altitude variations and different vegetable crops require different altitudes for successful growing and to give quality produce.

d) Day length

It is also an important factor, which has to be considered in the selection of some introduced or exotic types of vegetables, particularly those originated in the subtropics and temperate regions /in adapting to day lengths longer than 12- 13 hours/. Therefore, necessary to ensure that only cultivars, which respond to relatively short days or are day- length neutral, are grown best in most tropical regions including Ethiopia.

e) Wind

It is the very important climatic factor that should be considered during vegetable growing, since it creates damage to the growing vegetables, particularly those which are long in height and shallow

root system that makes them susceptible to strong wind. Especially in dry and hot weather wind also provoke rapid evapotranspiration rate and ultimately increased crop water requirement.

Soil

The soil should be investigated very thoroughly to assess its suitability for vegetable growing. The following factors are important: soil type, texture, structure, and permeability, content of essential elements, organic matter content and soluble salts. The soil naturally, has an important role to play in the life of any plants whose roots are growing in its media. Vegetables will grow on a wide range of soils provided that soils are fertile and well drained. Moreover, the drainage system and the natural fertility status of the soil need to be carefully considered. Heavy clay soils are generally difficult to work, particularly during the wet season, but can often be improved by the addition of organic manure and similarly, sandy soils, will also become more fertile with the addition of organic manure, which improves the humus content and therefore, the WHC.

The ideal soils for most vegetables growing are the medium clay loams rich with organic content and having a soil depth of not less than 0.75 m. But these soils have to be properly managed and further will need to be supplied with both nutrients and organic manure in order to maintain their fertility. The acidity or alkalinity of soil should be determined. In general, suitable pH values for soils carrying intensively cropped vegetables are in the range of 5.5- 7.5, although some crops such as tomatoes and peppers can tolerate slightly more acid soil conditions. Nematodes are becoming a serious problem in many vegetable-growing areas and it is difficult to control them effectively. Therefore, nematode free- areas should be selected for successful vegetable growing.

Water availability and quality

The tissues of vegetable crops generally contain up to 90 % of water and their water requirements are high. During the dry period, most vegetable crops will require irrigation and it is therefore, essential to select a site, which has the possibility of providing adequate water supply throughout the dry season. Water shortage, particularly during the critical growth stages has immediate repercussions on quality and yield and that water supply is thus, one of the most important factors in vegetable production. It is therefore, indispensable to adopt the dimensions of the area cultivated to the quantity of water regularly available, making allowance for all requirements, including pre-irrigation, the water necessary for leaching salts from active rooting zone soil and the water used for spraying and application of fertilizers. The sources of water could be from wells, streams, rivers or dams, which is constructed at the upper reach of the river and suitable for furrow irrigation system to be used.

The quality of irrigation water is also important; saline water is not suitable for most vegetable crops (very often water with an electrical conductivity of less than 250 micromhos is considered as good quality and suitable for most crops). An analysis of water quality, particularly the presence of potentially toxic salts should therefore, be considered, if crops grown previously have shown symptoms of leaf scorch or reduced growth. Therefore, in planning vegetable production during the dry season it is very important to undertake studies on the availability and suitability of irrigation water for vegetable crops. These include; water quality, suitability for irrigation and beneficiaries and flow of water through out the year.

Market outlet and transport

The production site to be selected should have an access to the market, if the crops are either to be sold locally or transported to distant markets. Most vegetables are highly perishable and are often harvested and sold on the same day. Therefore, availability of local, export markets and processing industries, range of species and varieties to be grown in order to meet the market demand, quantity and quality of produce and prices available at different seasons are important market information that should be collected and thoroughly analyzed in order to plan and make vegetable production more sustain and profitable.

A reliable form of transport to market is necessary if regular market supplies are to be maintained, but this is often difficult for the subsistence vegetable growers, like in Ethiopian condition. Therefore, for distant markets less perishable vegetable crops should be selected and more perishable ones should be grown either for home consumption or nearby local markets.

Inputs and human resource requirements

In the planning phase, based on the planned area to be cultivated, seeds of adaptable and high yielding varieties of vegetables with high quality and other inputs requirements such as fertilizers, chemicals and other equipment should be determined. Identifying of appropriate tools with the required quantity is also important to consider for efficient handling of vegetable garden activities. Human resources and social conditions should also be considered. The production of vegetable of good quality and obtaining of good yields calls for sustained and permanent efforts on the part of the grower. This include: technical knowledge for growing a variety of vegetable crops, capability of planning considering the market demand, foresee the requirements of inputs and arrange a suitable crop rotation cycle.

Production systems of vegetable crops

Vegetables are propagated either by vegetative means /shallot and garlic/ or by seed /carrot, cabbage, beetroot, melon/ or transplanted /tomato, cabbage, pepper/ from seedbed to the permanent field. Therefore, there are two production systems for vegetable growing:

- Seedling preparation and transplanting;
- Direct sowing to the permanent field.

Seedling preparation

In transplanted crops nursery practice should be followed for good stand establishment and for subsequent high yield and quality produces. If we decided to grow vegetables using transplanting seedlings it is important to select appropriate sites and arrange the required tools for seedling preparation. Seedlings are grown on nursery beds. Details of nursery beds preparation and sowing are discussed under each vegetable crop in the subsequent sections of this chapter. Hereunder,

are discussed points that should be taken as general considerations for a successful growing of vegetable crops. Crops such as pepper, onion, tomato, cabbage, cauliflower and the like are grown using seedlings. Growing of vegetables using transplanted seedlings has the following advantages:

- Transplanting gives a possibility of growing different vegetable crops at different seasons;
- It helps to use vegetable seeds more economically and save high priced seeds;
- It gives a possibility to grow protected seedlings from frost and transplanted later;
- It shortened the overall maturity period of the crop;
- Easy to eliminate weak and diseased plants that are not appropriate for planting and select healthy seedlings in order to obtain an even stand on the field and
- In most cases it avoids replanting to replace the missed plants, due to poor germination.

Nursery site selection

Great care should be taken in the selection of nursery sites for vegetable seedling raising activities in order to raise healthy seedlings. The following points should be considered in selecting appropriate sites for nursery production: (1) The site should be located as near as possible to water sources /has access to irrigation water/; (2) The nursery site should be separated from the main production field; (3) The site should be new, where similar crops were not cultivated during the previous seasons in order to avoid disease build- up and minimize nematode infestation; (4) The site should be located in an area not subjected to frost; (5) Not subjected to shading of trees and buildings, in order to avoid insufficient light penetration; (6) The site should be free of trees, stones, clods and weeds; (7) Not exposed to strong wind and/or protected from strong wind and sun; (8) The nursery site should be guarded or protected from the damage of higher animals; (9) The area should have a flat or slightly with gentle slope; (10) The site should have light and medium texture and well-drained soils. If the soil is heavy it should be improved by the application of organic matter and incorporation of sand and well- rotted compost in the ratio of 3 parts of soil, 2 parts of compost /manure and 1 part of sand.

Nursery bed preparation

The required nursery area should be calculated and the total area should then be demarcated and prepared. The following points should be considered in nursery seedbed preparation:

- As a primary task bushes, stones, and debris should be cleared;
- Good and fine seedbed preparation is very essential for most vegetable crops;
- Ploughing, harrowing and raing are the very essential operations for seedbed preparation in order to break up and level the soil surface for uniform and rapid germination of seeds;



Fig. 25. Raking for good seedbed preparation. (Source: Tadesse Debebe, Vegetables. 1994, Addis Ababa)

- Fertilizer should be applied to the nursery beds 2 to 3 days before sowing or planting at the rate of 50 and 30 kg/ha of P_2O_5 and N respectively for medium soil fertility level for a size of 1 m x 5 m or 100 and 60 kg/ha of P_2O_5 and N respectively for a size of 1 m x 10 m
- After the seedbed is thoroughly prepared 120 beds with a size of 1 m X 5 m or 60 beds with a size of 1 m X 10 m should be delineated to raise seedlings sufficient for 1 ha of land;
- The distance between beds should be maintained at 60 cm for ease of walking;
- Raised seedbeds are prepared for raising seedlings during wintertime or in higher altitude areas in order to avoid waterlogging problem, whereas in lowlands or moisture deficit areas sunken type of beds are recommended to hold and save more moisture.

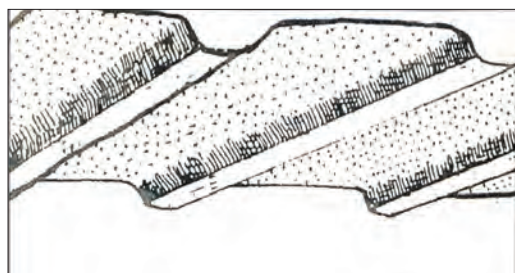

Fig. 26. Raised seedbed type for high rainfall area
Source: Tadesse Debebe, Vegetables. 1994, Addis Ababa

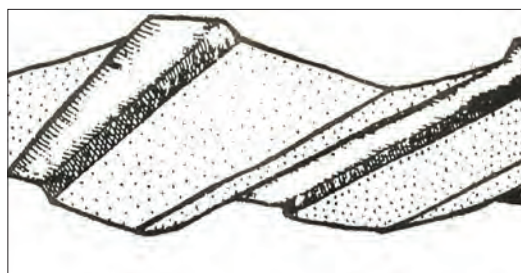

Fig. 27. Sunken type seedbed for low rainfall area

Nursery management practices

- Right after seedbed preparation is completed beds are irrigated before sowing;
- In each bed make lines by stretching a string from one side to the other side of the beds following the width of the bed at a recommended distance for each crop;
- Select seeds of the more adaptable varieties to the given localities;
- Drop seeds at the required soil depth 2- 3 times their diameter and should be covered with fine soils and the surface of the drill should then be lightly firmed;
- As soon as the seeds have been sown the soil should be thoroughly moistened and then the seedbed should be covered with a light mulch /with a 5 cm thickness/ of dry grass or straw to keep the soil surface moist and enhance rapid and easy seedling emergence;
- The seedbed should be irrigated immediately after sowing and irrigate the nursery bed twice a day during the early days, particularly during the germination process;
- The seedbed and young seedlings preferably be irrigated early in the morning and late in the afternoon hours;
- The seedbed should be regularly kept wet during germination period and excess watering should also be avoided preventing seedlings from disease attack, such as damping off;
- After germination is secured and seedlings are starting to develop the mulched grass should be removed carefully, just to avoid any etiolating of the plantlets;
- Construct shades in order to protect seedlings from strong sunlight, wind and hail damage;
- Carry out thinning operation to maintain optimum plant density in the nursery;
- Make weed free of the site in order to avoid competition for water, light and nutrients;
- Protect seedlings from insect pest and diseases attack primarily by preventive measures and by spraying appropriate chemicals whenever necessary;
- Water may be withheld from seedlings before transplanting in order to harden them; however the hardening period should not exceed one week.

Land preparation of the permanent field

Land preparation is the main operation undertaking in the main field. Land preparation is performed depending on the crop type to be sown, soil and climatic conditions of the area. The following are the general recommended practices to be undertaking for land preparation: (1) Clearing of the site from trees, weeds and bushes; (2) Stones, clods and debris should be cleared out of the field; (3) The site should be leveled by digging of hills and refilling of holes is essential, particularly when using surface irrigation methods; (4) Then using small garden hand tools or plough the field at a depth of 20- 25 cm on average; (5) It is essential to under plough crop residues and weeds immediately after harvesting; (6) Plough the land right after harvest, while the soil moisture is sufficient and the land is better workable; (7) Depending on the weather and weed problem frequent ploughing is important to reduce the build up of soil borne diseases and pests and avoid weed competition; (8) Crashing of clods and leveling is also important to make fine seedbed for uniform and rapid germination of

seeds; (8) Timely prepared seedbed increased infiltration of rainfall and improve soil aeration for normal growth and development of the crop; (9) After the land is well prepared the next operation is to prepare the field for sowing or planting and ridging for irrigation activities depending on the soil type, the crop to be grown and the method of irrigation to be applied.

Transplanting

Plants are usually ready for transplanting to the permanent field where it will be grown when they are at 10- 15 cm height. For about a week prior to transplanting, the seedlings should be “hardened” by reducing watering and giving them full exposure to sunlight. This process toughens the plant so as to withstand transplanting. The actual process of transplanting begins only after the permanent beds or fields are well prepared. The field should be pre- irrigated a day before to reach optimum soil moisture. The plants should be thoroughly watered 3- 4 hours before transplanting is to take place. If possible, transplanting should take place in the evening or on a cloudy day. The transplants are lifted using the appropriate tools such as a spade or towel and cares should be taken not to damage the seedlings. Loose soils are removed from the roots and the transplants are placed in a basket or similar container with moist sacking or banana leaves in which they are transported safely to the permanent field.

During the transplanting operation only and small number of plants should be removed from the shaded container at a time. The seedlings can be inspected as they are being prepared for planting and any diseased or very small seedlings should be discarded. Plants are set in the holes at the same level or slightly deeper than they were growing in the nursery. Care should be taken not to damage the roots of seedlings in planting holes, which are not deep enough. Irrigate after transplanting and the transplants should be irrigated regularly until they become established.

Direct sowing /planting

Seeds and bulbs or tubers of certain vegetables are directly sown or planted to the permanent field. This group includes: *watermelon, cucumber, pumpkin, beetroot, carrot, sweet potato, potato lettuce, Swiss chard, garlic, shallot and the like*. These vegetable crops are directly sown or planted to the permanent field by maintaining the appropriate planting distance and depth. As a general rule, large sized seeds are planted more deeply than small sized seeds in order to maintain more optimum and uniform germination and avoiding pest damage of seeds. For direct sown vegetable crops the following care should be taken: (1) before planting these vegetable crops the soil should be thoroughly well cultivated by means of ploughing, or digging. Most vegetable crops will always do best under conditions of “clean” cultivation, which means keeping the surface soil loose and free of weeds; (2) for most direct sown vegetables it is important to irrigate the land 1 to 2 day prior to sowing; (3) for crops to be sown on beds make lines by stretching a string from one side to the other following the length of the bed at a recommended planting distance of each crop; (4) small sized seeds such as carrot should be mixed up with sands in order to maintain the right seeding rates; (5) right after sowing mulch the seedbed with grass and reduce the grass gradually after germination; (6) irrigate the field following the appropriate irrigation interval and (7) carry out thinning operation timely, whenever required, to maintain optimum plant density.

Fertilizer application









A constant optimum yield depends, besides other factors on the availability of essential elements and the content of organic matter in the soil. Therefore, an irrigation agronomist has to maintain the content of plant nutrients and organic matter at a level sufficient for the particular crop demand by applying mineral and or organic fertilizers.

Tools and equipment required for vegetable growing

In the planning phase for vegetable growing it will be important to identify the tools to be used for effective handling of each operation. The tools usually used for vegetable growing can often be made in the village or could be purchased from nearby local markets or suppliers, in order to minimize their cost. There are many different tools that can be used for vegetable growing. Having the most appropriate tools will make things easy for better working condition and finish the work quickly. Tools can get damaged and easily lost. These garden tools should be kept in the nursery plant house to protect them from rusting during wet weather and metallic materials should be greased and oiled after use and their period of service will be considerably extended. Therefore, as a rule after work, it is important to clean them and put them away tidily.

The basic tools required for small-scale vegetable production may be limited to machete, hoes different types, rake, spade, watering can, wheelbarrow and secateurs. The main tools used in vegetable growing are listed in Table 28.

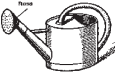
Table 28. Main tools used in vegetable growing

Tools	Uses	Schematic illustration
Machete	◆ Used for clearing of debris from the field, for general cutting operations and for trimming of weeds and bushes	
Spade	◆ Used for working the soil and to incorporate manures with the soil	
Digging fork	◆ When the soil is clayey or contains a lot of stones, it is better to use the digging fork. The digging fork is also used for applying manure. For removing stones, you can use a forked hoe.	
Digging hoe	◆ The digging hoe is used for many purposes: to break up lumps of earth when the soil is dry, to prepare the beds, for burying organic residues and earth up the plants	
Pulling hoe	◆ The pulling hoe is used for weeding and inter-cultivating between the rows.	
Dibber	◆ The dibber is used for transplanting seedlings.	
Watering can	◆ The watering can is used for watering vegetables without damaging them. The watering can has to be fitted with a rose.	
Rake	◆ Used to break up clods, to level the beds prior to planting, and to cover up seeds after sowing.	
Tamper	◆ The tamper is a wooden board used for firming the soil after sowing	
Length of cord	◆ Used for tracing straight lines for sowing and transplanting	
Wheelbarrow	◆ The wheelbarrow is used for carrying manure, compost, fertilizers, etc.	
Powder duster or sprayer	◆ Used for applying dusts for pest control and for spraying chemicals to control pests	
Trowel	◆ For transplanting seedlings	

In addition to the garden tools listed in Table 28 above, there are also other tools, which may be very useful for vegetable growing. Therefore, it is advised to use the more appropriate tools locally available and easily purchased with minimum possible price.

Cropping pattern

The area, which is to be allocated to each crop, has to be planned well in advance so that seeds can be obtained and the land adequately prepared as per the crop requirement. The type and size of bed to be used for specific crops has also be decided in advance although it is customary for most vegetables to be grown on beds of equal dimensions, varying the planting distances in accordance with the size of the crop and its nutrient requirements. The main choice is between the use of ridges or beds and if the latter, between sunken or raised beds based on specific climatic conditions of the area. In low

rainfall areas sunken beds are used, particularly for dry season cultivation, so that all water supplied is directed around the root system. Flat beds sometimes used for dry season cultivation for crops like tomato and pepper, but the use of slightly raised beds or low ridges is generally preferred.

Crop rotation

Vegetables, like all crops should be rotated. The principal aims of crop rotation are reducing the build up of soil borne diseases, insect pests and nematodes; minimizing weed infestation and increased crop yields, maintaining soil fertility, protection of soil erosion, increasing nitrogen content in the soil, sustain proportional utilization of soil nutrients by crop plants, allowing crops to plant in sequential order considering their characteristics. Therefore, the following are important factors to be considered in establishing crop rotation cycle: Selection of crops considering the soil and climatic conditions of the area, inclusion of legume crops in the rotation cycle in order to improve the soil fertility, putting crops in their sequential orders by considering their root systems and nutrient uptake behaviors of crops, in putting crops in sequential orders it will be vital to consider weed situation of the area, disease and insect pest infestation nature of crop in order to reduce weed problem, and minimizing disease and insect pests build up in the soil, considering market situation and cultural practices of the area and further it is necessary to check whether the crop selected for planting will grow during the season of the year for which it is scheduled or not.

Whenever possible vegetables from the same families should not be grown in the same field year-after-year, at least there must be allowed 2 to 3 years elapse between crops of the same family. It is particularly important that the solanaceous crops such as tomato, potato, pepper and eggplant should not follow each other on the same field. Similarly, the same applies to cucurbits family such as melon, cucumber, pumpkin and squash. In addition, deep-rooted crops should follow shallow rooted vegetable crops in order to improve the efficient utilization of nutrients by the crops. The inclusion of legumes in a rotation has the added advantage of improving soil fertility by adding nitrogen to the soil through the activity of nitrogen-fixing bacteria which are associated with the roots of legumes and if residues are turned to the soil some of the nitrogenous material remaining in the roots and other plant parts will contribute to soil fertility. In order to establish and obtain optimum yield it is important to keep records, of which indicate the crop type sown previously in each field to plan the new crop to be planted in the same field /see Table 29/.

Table 29. Crop rotation cycle

Production year	Crop rotation cycle				
1	Onion	Cabbage	Tomato	Swiss Chard	Beans, green
2	Cabbage	Tomato	Swiss Chard	Beans, green	Onion
3	Tomato	Swiss Chard	Beans, green	Onion	Cabbage
4	Swiss Chard	Beans, green	Onion	Cabbage	Tomato
5	Beans, green	Onion	Cabbage	Tomato	Swiss Chard
6	Onion	Cabbage	Tomato	Swiss Chard	Beans, green

Succession cropping

The practice of planting the same vegetable crop on several dates 2 or 3 weeks apart or planting of early, mid- season and late season cultivars at the same time is called successional cropping. It is important because vegetables have a very short but relatively uniform growth period and therefore, tend to be ready for harvest at one time. This will create over-flooding of the market and resulted in reduced price, and ultimately the farmers will be discouraged of not getting sufficient return for

their produce. Furthermore, there won't be continuous supply of fresh vegetables and this will in turn affect both the home consumption and the market as well. Therefore, considering the specific environmental conditions of the area, crop varieties and the market demand and price situations of the area throughout the season it is recommended to plant high value crops of adaptable varieties at different planting times in order to get the maximum return from the crops grown.

3.1 SELECTED VEGETABLE CROPS

3.2.1 ONION /*Allium cepa* L./

CROP DESCRIPTION AND ITS USE

Onion is among the bulb crops, which are economically important in human diet. In particular, it has considerable importance in the daily Ethiopian diet and has the potential for domestic use and local processing industries as well. Of course, the traditional shallot was widely used in the past, but currently the onion is substituting it. However, onion at large-scale level is being produced mainly for export purpose. Practically, all plant parts are edible, but the bulbs and the lower stem sections are the most popular as seasonings or as vegetables.

The onion is probably native to the Middle East region. The edible onion bulb averages 85 to 87 % water, 1.4 % protein, 10 % carbohydrates, 0.2 % fat, and about 0.6 % ash. It is rich in calcium and moderately supplied with phosphate and iron. It is classed as an energy food, because the calories are supplied largely from carbohydrates /mostly sugars/, but vegetable is well known most for their flavoring. All parts of the plant contain the pungent principle that makes onions desirable as seasoning herbs. The pungent principle is, due to volatile sulfur compounds. In most cases, it is being produced for marketing and for earning cash. Onion production in Ethiopia among the subsistence farmers is mainly considered for the market and cash earning. However, it is also being produced partially for home consumption. The preference of onion in Ethiopian diet is for a very pungent onion with red skin, high solids and good storage quality.

VARIETIES

Onions are strongly influenced by day length to produce bulbs and only short- day varieties are adapted to Ethiopian condition that is to say, a day length of approximately 12 hours. Varieties that are either long or intermediate are not adapted to Ethiopian condition, since they are not producing bulb, grown in region having 12 hours day. Varieties adapted to specific areas must be resistant to diseases, and have good size and yielding capacity, long storage properties and the pungency or flavor desired of the onions. The recommended varieties under irrigation are, therefore, Adama Red, Red Creole, Bombay Red and Melkam Red (Pusa red). However, Red Creole is not widely adapted and usually imported seeds of this variety have low quality standards. However, it has some resistance to leaf diseases such as powdery mildew and purple blotch. Experience of some farmers, in some parts of the country revealed that Bombay Red is more preferred by the farmers, mainly due to better market demand and of course, its productivity level has also significant role for its acceptance. However, the problem is that it produces split bulbs and inferior quality for storage. Adama Red has more pungent property than the others and keeps

well and widely used for local consumption and for export. These improved varieties of onion have low resistant to diseases, particularly susceptible to purple blotch disease and onion trips attack. The Ethiopian shallot is resistance to leaf diseases and for this reason, rainfed production by the subsistence farmers is then recommended.

Table 30. Major varietal characteristics of common varieties of onion

Variety	Bulb colour	Average weight of the bulb (g)	LGP (days)	Average yield (qt/ha)
Adama red	Deep red circular in shape	65- 80	120- 135	350
Melkam red	Red	85- 100	130- 142	400
Red Cereole	Dem red	60- 70	130- 140	300
Bombay red	Dem red	70- 80	135- 145	300

Source: Melkasa Agricultural Research Centre, December 2001.

SOIL AND CLIMATIC REQUIREMENTS

Soil

Onion can be grown on different soil types but well- drained medium textured soils rich in organic matter content are more preferred. Optimum pH is in the range of 6 to 7. The crop is sensitive to soil salinity and yield decrease varies at different levels of salinity /ECe/. In particular, young seedlings are susceptible to salt injury so direct seeding on saline soils should be avoided. Heavy black soil is not suitable for onion bulb development.

Altitude

The length of the growing period varies with climate but in general, 130 to 175 days are required from sowing to harvest. In most cases onion widely grown in the mid and high altitude areas of 700 to 2400 m a.s.l, but altitudes from 1200 to 1800 m a.s.l are very suitable for onion production. Onion is moderately resistant to frost. Cool weather in higher altitudes, slows down the normal growth of the plant and instead it encourages the plant to initiate flowering.

Temperature

For the initial growth period, cool weather and adequate water is advantageous for proper crop establishment, whereas during ripening warm, dry weather is beneficial for high yield of good quality. The optimum mean daily temperature is from 15 to 20°C (18- 23°C day and 10- 12°C night). Proper crop variety selection is essential, particularly in relation to the day length requirements in order to produce the bulb.

Rainfall

For optimum yields onion requires 350 - 550 mm water throughout its growing period. Onion, as most vegetable crops, is sensitive to water stress and yield is significantly affected. Therefore, for successful onion production the availability of irrigation water, particularly for dry season

production is important. Onion is shallow rooted crop and it could not extract water from deep soil layers. This requires the application of irrigation water more frequently but light irrigations should be applied.

RECOMMENDED IRRIGATION AGRONOMIC PRACTICES

Land preparation

Onions develop the end of their stems underground or at a certain depth below the surface of the soil. This part of the stem, which further enlarged within the soil, is called the bulb. The bulb grows quickly and becomes large if the soil is light, not too moist, rich in humus and free from weeds. If the soil is very moist, the bulb may rot. In a well-tilled soil, the water goes down deep and air can get in. So it is important to till the soil deeply. Depending on the specific environmental conditions the land should be ploughed and leveled accordingly. After the field is well leveled furrows at a spacing of 0.40 m for irrigation water application should be prepared. Then the field preferably pre-irrigated one or two days before transplanting.

Planting

The crop is usually sown in the nursery and transplanted after 40 to 45 days. Direct sowing in the permanent field is also practiced but requires high capital investment. However, transplanting after 40 to 45 days of sowing in the nursery is more advantageous in Ethiopian condition, since labour is not so expensive. Because transplanting gives a possibility to select healthy seedlings for planting, it shortened the overall maturity period of the crop, easy to eliminate weak and diseased plants in order to obtain an even stand on the field and in most cases it avoids re-sowing /replanting activities to replace the missed plants, due to germination problem. The crop is usually planted in rows or on raised beds, very often with two rows in a bed, with a spacing of 0.3 m between rows and 0.1 m between plants.

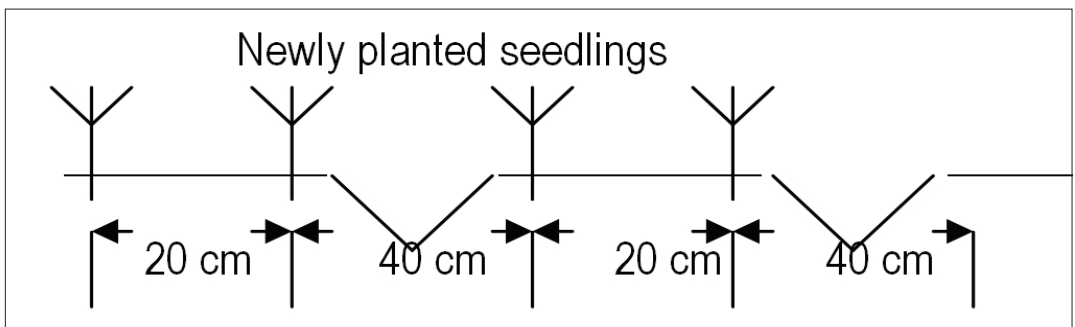

Fig.28. Planting system of onion on the top- flat beds in double rows

Nursery site selection

Appropriate nursery site selection should be given prime importance in onion seedling raising activities in order to raise healthy seedlings. The points to be considered in nursery site selection for onion is the same as for other transplanted vegetable crops discussed under the “General considerations”.

Nursery management practice

The nursery management practices for onion is the same as for other transplanted vegetable crops (refer to the “General considerations for vegetable growing under nursery management practice”). The recommended seeding rate is 3.5 kg/ha and 50 g of seeds for a size of 1 m X 5 m plot nursery is sufficient, 100 g for the size of 1 m X 10 m. But for direct seeding in the permanent field 7 kg/ha is required. For uniform distribution of seeds it is preferable to mix the seed with sand.

Transplanting

- Seedlings will be ready for transplanting to the permanent field after 40 - 50 days of stay in the nursery site, or when the seedlings develop 2 to 3 true leaves /at 12 to 15 cm height/;
- Transplanting of seedlings preferably be done in the morning and late in the afternoon hours in order to avoid wilting of seedlings;
- It is necessary to irrigate the seedbed two days before transplanting for ease of uprooting seedlings and to minimize damage to roots;
- Uprooting of seedlings should be done very carefully in order not to damage the roots;
- The recommended planting system for hand cultivation is by making flat top ridges with furrows between the ridges;
- Plant double rows on the flat ridges 20 cm apart and the spacing between double rows is 30 to 40 cm and spacing within the row is 10 to 15 cm;
- Leaves and roots of seedlings should not be trimmed;
- Seedlings must be planted in the soil below the surface but the base of the seedlings should not be more than 2 to 3 cm deep in the soil;
- Irrigate the newly planted seedlings immediately after transplanting;
- After 7 days of transplanting it is necessary to carry out replanting in places of missed seedlings;
- Do not earth up the onion plants when you cultivate; if you cover the bulb, it won't grow well.

Weed control

Weed control is highly essential for successful onion production. The slow growth- rate of the onion in its initial stages, combined with its open growth habit of the crop and due to the shallow root system of the crop, competent from weeds can be very severe. Therefore, the crop needs to be inter- row cultivated and weeded at least 3 times throughout the growth periods. Depending on the weed situation, particularly at early growth stages the crop should be weeded frequently and kept free of weeds. The first cultivation and weeding should be done after 15 days of transplanting, the second and third on the 30 and 50 days after transplanting. It is very important to avoid excess

soiling up on the tops and stems of the plant in order to prevent sharpened bulbs formation and thin skin development that can elongated maturity period and reduced storability of the produce.

Fertilizer application

It is best to grow onions after salad plants such as lettuce and the like. Salad plants do not use all the mineral salts in the soil. Onions use up the salts that remain from the manure you put down for the first crop. Applying fertilizers, is therefore, very important under onion crop. Onions need above all potassium and phosphorus. Sulfur is often very useful too. The amount of fertilizers in the form of DAP and Urea should be mixed together and applied during the seedbed preparation. Nitrogen fertilizer should be given gradually and moderately, since an excess application causes the formation of thick collars to the bulbs and reduces keeping quality. As a result of excess nitrogen application, the plant may also develop more leaves than the bulbs and consequently the yield will be reduced. The recommended amount for the seedbed size of 1 X 5 m is 52 g of DAP and 33 g of Urea and for the seedbed size of 1 X 10 m is 104 and 66 g of DAP and Urea are required respectively. But in the permanent field under onion crop 200 and 100 kg/ha of DAP and Urea are required respectively. However, in some areas of the Upper Awash and Melkasa 92 kg/ha of nitrogen is recommended to use, where the first half is applied as a basal application and the second half one month of after transplanting. DAP is applied fully as a basal application in the form of band placement in order to avoid loss through fixation. Application of irrigation water is essential immediately after fertilizers are applied.

Water requirements

For optimum yields onion requires 350 - 550 mm water throughout its growing period. Onion, as most vegetable crops, is sensitive to water stress. Onion is shallow rooted crop not more than 30 cm deep and it needs frequent but light irrigations. For optimum yields the soil water depletion should not exceed 25 % of the available soil water. When the soil is kept relatively wet, root growth is reduced and this favors bulb enlargement. Irrigation should be discontinued as the crop approaches maturity to allow the tops to dry out and also to prevent a second flush of root growth and avoid problems of curing.

The crop is very sensitive to water deficit during the yield formation period, particularly during the period of rapid bulb growth, which occurs about 60 days after transplanting. The crop is equally very sensitive during transplanting from the nursery to the permanent field. For a seed crop, the flowering period is very sensitive to water deficit. During the vegetative period the crop appears to be relatively less sensitive to water deficit. For high yield of good quality the crop needs a controlled and frequent supply of water throughout its growing periods. However, over-irrigation increases disease susceptibility of the crop and reduces growth as a result the final yield will be reduced. Therefore, in order to achieve large bulb size and high bulb weight, water deficit during the yield formation period /bulb enlargement/ should be avoided. Under limited water supply condition water saving can be made during the vegetative and ripening periods. However, onion production under such conditions water supply should be preferably be directed toward maximizing production per hectare rather than extending the cultivated area with limited water supply.

The crop as indicated above has a shallow root system with roots concentrated in the upper 0.3 m soil depth. In general, 100 % of the water uptake takes place in the first of 0.3 to 0.5 m soil depth. It is essential to schedule irrigations of onion to maintain a continuous high soil moisture levels. In this regard the crop requires frequent but light irrigations, which should be planned to irrigate when the 25 % available soil water in the first 0.3 m soil layer has been depleted by the crop.

Irrigation should be scheduled by observing soil moisture level and not by observation of the crop. In the initial growth stages up to four weeks period of time after transplanting it will be necessary to apply irrigation water at every 4- 5 days interval and every 5 to 7 days is commonly practiced then after. Over- irrigation sometimes causes spreading of disease such as downy mildew and white root rot. Irrigation should be discontinued 15 to 25 days before, harvest. The most common irrigation methods applied under onion crop are furrow and basin.

CROP PEST CONTROL

Disease control

Various diseases may attack onions. However, downy mildew /*Peronospora destructor*/ and purple blotch /*Alternaria porri*/ are the major diseases that attack onion severely, particularly during the rainy season and when the humidity is high.

Symptoms of purple blotch

Sunken spots at first water- soaked but rapidly becoming violet/brown, and often zoned and with a yellow hollow, appear on leaves and seed- stalks. Under wet conditions these spots enlarge and elongate, destroying the leaf and stalk tissue. The fungus can also cause a rot of the bulb. Usually, the infected leaves turn yellow and die within 3 to 4 weeks. However, stalks are often girdled and fall over before the seeds mature. The fungus gradually grown down from the leaves and affected the bulb.

Downy mildew

The onion mildew is caused by *Peronospora destructor*. The disease is so destructive under moist conditions. The pathogen over- winters as mycelium in the onion bulbs and sometimes in the seeds as well.

Symptoms

White to purplish fruiting in elongated white or tan unless the *Peronospora* is followed by other fungi that cause a black mold covering. Usually, the fungus coats the outer surface of old outer leaves first, and when the disease has progressed downward to the leaf sheath, the leaf drops over and then the whole plant becomes yellowish and dies.

Recommended measures for the control of the aforementioned diseases are: (1) Never grow two crops of onions one after the other and keeping a four year crop rotation cycle with cereals and pulses is highly important; (2) Make the field free of weed /weeding at least 2 times in the growing period/; (3) Whenever necessary weekly spray with 3.5 kg/ha rate of mancozeb and zineb or 3 kg of ridomil for 3 to 4 times by mixing up with 600 liters of water; (4) For rainy season production, preferably it is advised to use shallot under supplementary irrigation and not onion; (5) Onion is recommended to be cultivated during the dry season under irrigation; (6) Under rainfed condition it is important to make sure that the crop maturity should overlay with dry weather condition.

Onions are also very susceptible to *white rot Fusarium*, Pink rot, even though they are not serious in Ethiopia and several other types of nematodes. Root rots are due to fungus, which attack

onion seeds, destroy the roots and bulbs of seedlings, then further cause the leaves to wither and kill the onion plant. Control rots by disinfecting the soil with boiling water, or with Formol.

Crop rotation

In order to avoid the build up of soil borne insect pests and plant diseases crop rotation is recommended under onion crop. Onion could be rotated with crops such as cabbage, tomato, Swiss chard, lettuce and green beans.

Insect pest control

Onion thrips, leaf miners and cutworms and wireworms are some of the common insect-pests that attack onion. Onion thrips */Thrips tabaci/* are one of the most common insect pests that attack onion in the dry season, particularly in hot, dry climates. These tiny, yellowish sucking insects attack the onions leaves, giving them a blanched appearance.

Damage: Both nymph and the adults rasp the surface tissue of the leaves, causing wounds from which flows the sap on which the insect feeds. The leaf surface of attacked plants bears fine, silvery- white mottling and flecks; the leaves may shrivel and the leaf-tips become dried- out and papery. In the case of a heavy attack, yield losses can be serious, with stunted leaf- growth, reduced bulb size and in extreme cases, death of the plants.

Control: When 5 to 10 insects are observed per plant it is possible to control the pest by using one of the following insecticides. These are: (1) Spraying with 0.5 l/ha of cypermethrin 10 % E.C mixing with 200 liters of water and spray every two weeks for 3 to 4 times; (2) Spray with 3 l/ha of thiodan by mixing with 600 liters of water and spray every 1 to 3 times; (3) Dipping onion seedling in the solution of one spoon of diazinon 60 % E.C and 5 liters of water that can protect onion from thrips attack.

HARVESTING

- Onion can be harvested within 80 to 100 days after transplanting;
- Bulbs are ready for harvesting when 75 % of the tops are dry and fall on the ground, but before the foliage has dried down completely. If it is harvested before it does not keep well;
- When the crop is matured for harvesting it is advisable to harvest using appropriate hand tools such as forks and care should be taken not to damage the skin;
- Bulbs should be harvested before the tops are completely dried up, otherwise the bulb will decay on the root;
- It is best to lift onion bulbs, when it is not raining, so that they will not rot;
- In the dry season it is possible to leave the fresh harvest bulbs on the field for at least a week period so as to dry them well, covering them with a little grass or straw or with its own leaves in order to protect them from strong sunlight and to protect from cold weather;
- When it is dried detached the bulbs from the tops leaving at least 1- 2 cm of top is usually

left on the bulb to prevent disease entrance;

- Roots should be trimmed as close as possible to the bulb, but tops should be trimmed at least to a length of about 1 to 2 cm;
- Put bulbs in an open mesh bags to complete curing. If it rains, dry the onions under shelter;
- Transport dried onions to the packing and grading center;
- Sorting disease affected, damaged or decayed bulbs and grading is important and store in cleaned and ventilated storage facilities.

Storage

Only onions, which have been properly dried or cured, are suitable for storage. Rapid development of rot diseases and premature sprouting of can be expected if improperly cured. Onions are best stored in loose stacks up to 50 cm deep with good ventilation. Onions should not be bagged until required for marketing. Size grading and eliminating defective bulbs should be done before storage. Large sized bulbs may be expected to have shorter storage life than smaller ones and should be, therefore, be stacked separately. The onion store should be sited where there is good air movement for ventilation.

3.2.2 TOMATO / *Lycopersicum esculentum* – L./

CROP DESCRIPTION AND ITS USE

Tomato is the most important crop next to potato. It is grown as annual crop and produced for its fruits. The tomato crop is one of the most popular and important vegetable crops produced for fresh consumption as well as for processing. The processed tomato can be in the form of tomato juice that can be directly used and tomato sauce that is used for the preparation of different kinds of meals. There are different varieties of tomato that can be used both for fresh market and for processing. Tomato is considered as one of the high value crops being produced both at commercial farms and at smallholders' levels. Therefore, the economic return from tomato production is highly promising

VARIETIES

Choice of variety is very important since there's much variation in disease resistance, time till harvest, size and shape of fruits, and use. Actually there are two different habits of growth of tomatoes- determinate /dwarf/ and indeterminate /tall- growing/. The determinate varieties of tomato are bush- like, compact in growth, and mature their fruit within a relatively short period. The advantages of these varieties as compared with indeterminate are that staking to support the plants is not a must and mechanical harvest is possible. The yields are comparable with yields of indeterminate varieties. This group includes varieties with a high content of total soluble solids used for processing as well as varieties for the supply of fresh markets, whereas indeterminate varieties are high in stature, open or rangy in growth and they develop their fruit during a relatively long period of time. These varieties require high labour for maintenance /staking/. The recommended varieties under irrigation are:

- Marglobe - long maturing variety which requires staking and suitable for fresh market;
- Money maker “ “ “ “ “ “;
- Roma VF, which does not need staking /suitable both for processing and fresh market/;
- Melka Shola and Melka salsa both for processing and determinate varieties / suitable both for processing and fresh market/.

Further details of the recommended varieties of tomato are shown in the following Table 31.

Table 31. Major varietal characteristics of tomato

Variety	Fruit shape	Average wt. of fruits g	LGP days	Productivity, qt/ha		Special varietal characteristics
				Research	Farmer	
Marglobe	Globular	120- 140	100- 110	320	300	Tall and required staking
Money Maker	Round	60- 65	110- 120	300	300	“
Roma V.F	Pear	50- 60	95- 100	400	-	Short and no need of staking
Melka Salsa	“	40- 50	100- 120	430	-	“
Melka Shola	Cylindrical	60- 70	100- 110	450	-	“

Source: Melkasa Agricultural Research Centre, December 2001.

SOIL AND CLIMATIC REQUIREMENTS

Soil

Tomato can be grown in a wide range of soils but well drained, light loamy sand to silty loam soils with pH of 5 to 7 are more preferred. The requirement on the organic matter content of the soil is not so high, but soils with medium organic matter content have better yields than soils with low organic matter content. Good soil drainage is also important. Tomato roots go deep down into the soil. Tomatoes, therefore, need a deep soil. Waterlogging increases incidence of diseases such as bacterial wilt. When there is excess water in the soil the roots cannot breathe and they will gradually rot. The crop is moderately sensitive to soil salinity. However, the most sensitive period in relation to salinity is during germination and early plant development stages. Therefore, pre-irrigation is quite important to leach down the excess salt accumulated on the active rooting depth to minimize salt hazard to the crop during the initial irrigation application is a prerequisite.

Altitude

Tomatoes are growing best in a warm and dry climate and not withstand cold weather. Damp air and rain encourage diseases, especially blight. Therefore, in regions, where the air is very damp, it is best to grow tomatoes in the dry season under irrigation. Tomato is a rapidly growing crop with a growing period of 90 to 150 days depending on the specific environmental conditions. It is a day length neutral plant. Even though, the crop can be grown in areas having altitudes below 2500 m above sea level, altitudes ranged from 1100 to 1800 m above sea level are considered to be the best areas for its successful production.

Temperature

The optimum mean daily temperature for growth is 18 to 25 °C with night temperatures between 10 and 20 °C. The crop is very sensitive to frost. Therefore, the crop should be grown in a frost-free period. Temperatures above 25 °C when accompanied with high humidity and strong wind resulted in weak growth and reduced yield. High humidity leads to a high incidence of pests and diseases and fruit rotting. Dry climates are, therefore, preferred for tomato production. Temperatures above 32 °C during fruit development inhibit the formation of red colour. In Ethiopian condition the best harvesting season, particularly for processing tomatoes is from December to June under irrigation condition. Thus, the first sowing date in the nursery is in the early September towards the end of the rainy season, and the last harvesting date is in June before the start of the rainy season.

Rainfall

Tomato can be grown successfully with an average annual rainfall of 500 mm depending on the climatic condition of the area.

RECOMMENDED IRRIGATION AGRONOMIC PRACTICES

Nursery seedbed preparation and management practice

The tomato seed is generally sown in nursery plots and emergence is approximately within 10 days. Seedlings are transplanted to the permanent field after 35 to 40 days. But direct seeding in the field is also practiced. However, transplanting is more preferable than direct seeding. The same nursery bed preparation is recommended as it is indicated under the general considerations for vegetable growing. However, the following need to be considered: adding of 200 g of DAP and 100 g of Urea during seedbed preparation, preparing of the seedbed for sowing, sow the seeds in 1cm depth in rows, leaving approximately 10- 15 cm between rows and 5 cm between plants; mulching of the bed immediately after sowing with thin layer of grass or straw is essential and 250 - 300 g seeds per hectare is sufficient. With regard to the seedling management practices refer to the general considerations for vegetable growing recommended under nursery management practice.

Land preparation

Tomato roots go deep down into the soil. Tomatoes, therefore, need a deep soil and must be tilled fairly deep. The permanent field where tomato seedlings are going to be transplanted should be ploughed at 25- 30 cm depth and cultivated with optimum frequency, till the soil is finely prepared. The soil of the tomatoes field should be prepared several weeks before transplanting. When tilling, add manure and incorporate thoroughly with soils. Then after the field is well prepared it is possible to make furrows at 60 cm width and maintain a distance of 90 cm between each furrow or 50 cm furrow width and keeping 100 cm distance between furrows.

Planting

Among the commonly cultivated and recommended varieties of tomato; Money- Maker and Marglobe are varieties that need supporting stand or staking and are usually planted using a planting space of 20 cm between plants within the row and 150 cm between rows of which the 100 cm is the size of the flat bed and the 50 cm is the furrow width through which irrigation water is applied and planting is taking place in single row using one side of the ridge approximately 10 cm from the edge of the bed. With this planting distance there will be a plant population of 33, 000 in a hectare of land. The other varieties are growing without staking and the recommended planting distance for them is 20 cm between plants within the rows and 140-150 cm between rows.

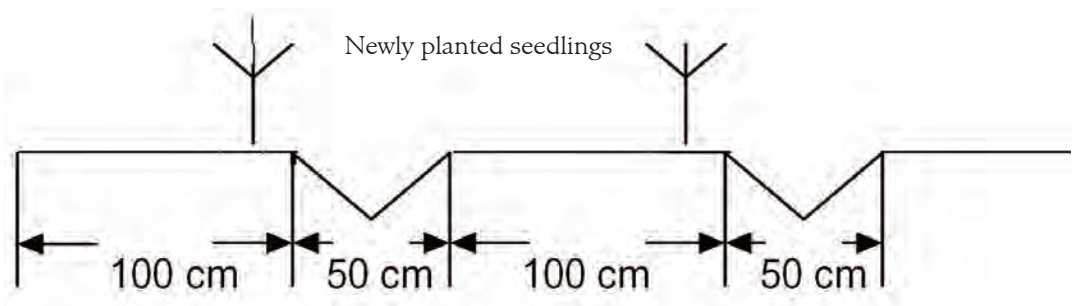

Fig. 29. Planting system of tomato on the flat top beds.

As it indicated above the tomatoes should be transplanted about 10 cm from the edge of the bed. Later on the position of the furrows should be changed gradually during cultivation by hand. The planting rows should be in the middle of the bed at the time of fruit development and the fruits won't have a chance to be dropped in the furrows and get wetted by the irrigation water.

Transplanting

For transplanting tomato it will be important to follow the same recommended procedures highlighted under the general considerations for vegetable growing. In a specific manner the following could be considered: (1) Within 4 to 6 weeks time or at 12 - 15 cm height or 2 - 3 leaves stage /35 - 40 days after seeding in the nursery/ the seedling will be ready for transplanting to permanent field; (2) The seedlings must not be dry out in the hot sun and are placed in a basket of similar container with moist sacking of banana leaves; (3) Plant seedlings in a row keeping a distance of 30- 50 cm between plants and 90-100 cm between rows and seedlings are set in the holes at the same level or slightly deeper than they were growing in the nursery; (4) Irrigate the newly planted seedlings immediately after transplanting and regular watering until the seedlings are established; (5) After the plant has been established and developed deep roots, the plants from the edge of the bed should be brought to the middle of the row during cultivation and the watering could be extended depending on the climatic and soil conditions of the area.

Weed control

Tomato is most sensitive to weed competition at the early growth stages. The parasitic weed, *Orobanche* deserves special attention, even though it is not severe at present in Ethiopian condition. Weed control in tomato field is very important starting from the early stage of the crop development and should be performed at different stages of growth based on weed infestation. Therefore, the crop needs to be cultivated and weeded at least 2- 3 times throughout the growth periods. Cultivation is taking place for the purpose of removing weeds, which will compete with the crop for water, light and nutrients. Another function of early cultivation is to move soil towards plants planted initially near the edge of the bed. About three such operations are required to bring the plant rows to the centre of the bed before the shoots start to hang into the furrows. The first cultivation and weeding should be done after 20- 30 days of transplanting, the second and third on the 45 and 50 days after transplanting. After the crop has established and makes substantial growth, it withstands further competition of weeds. Transplanted tomato seedlings are more sensitive to weed competition than direct sown ones and yield losses, due to weed competition are significantly high, if no weed control practice is applied /about 70 % loss/.

The following are the major recommended weed control methods in tomato fields: (1) Take out and burn diseased plants and remove insect damaged plants as well; (2) Replace the diseased plants removed by the seedlings from the nursery beds; (3) The parasitic weed- *Orobanche* can be a serious problem in tomato field. It is spreading by wind, irrigation water, humans and animals. Control this parasitic weed before seed setting and (4) Weeding and cultivation should be performed before irrigation water is applied.

Fertilizer application

The tomatoes are responsive for both nitrogen and phosphorus fertilizers. The needs of tomato for nitrogen are moderate until fruit set. An excess of nitrogen causes luxuriant vegetative growth, retards production and decreases fruit quality. Phosphorus is also important throughout the growth of the crop and deficiency of phosphorus causes violet coloration of the foliage. Therefore, it is recommended to apply 100 kg/ha of DAP during land preparation or at planting time and 100 kg/ha of Urea half at the time of planting and the rest half 45 days after transplanting by applying in both sides of the plant in a row and incorporate it immediately with the soil, then irrigate the field. If there is a possibility to get organic manures in the surrounding area it is advisable to use mineral fertilizers in integration with organic manures /add 100- 200 qt/ha of manure 2 to 3 months before transplanting and thoroughly incorporated with the soil/.

Staking

Tomato is among the crops that need staking. Staking improves production and quality by keeping the fruit off the ground, thus minimizing disease infection and rooting. In addition, harvesting is made much easier and photosynthesis may be increased through improved light penetration into the canopy of the crop. In this case, indeterminate varieties /tall- growing/ such as money-maker and marglobe are cultivated with staking. So that it is recommended to prepare staking from any local materials and carried out in many different ways. Stakes can be put in the beds before transplanting or it could be placed later. Whatever, the method is used; it is essential that the stakes should be strong enough to support the mature, fruit laden crop. The stakes should be fairly strong and about 1.5 m high. When the plant is growing about 40 cm, it is the right time to tie it to the stakes with raffia /see figure 30/.

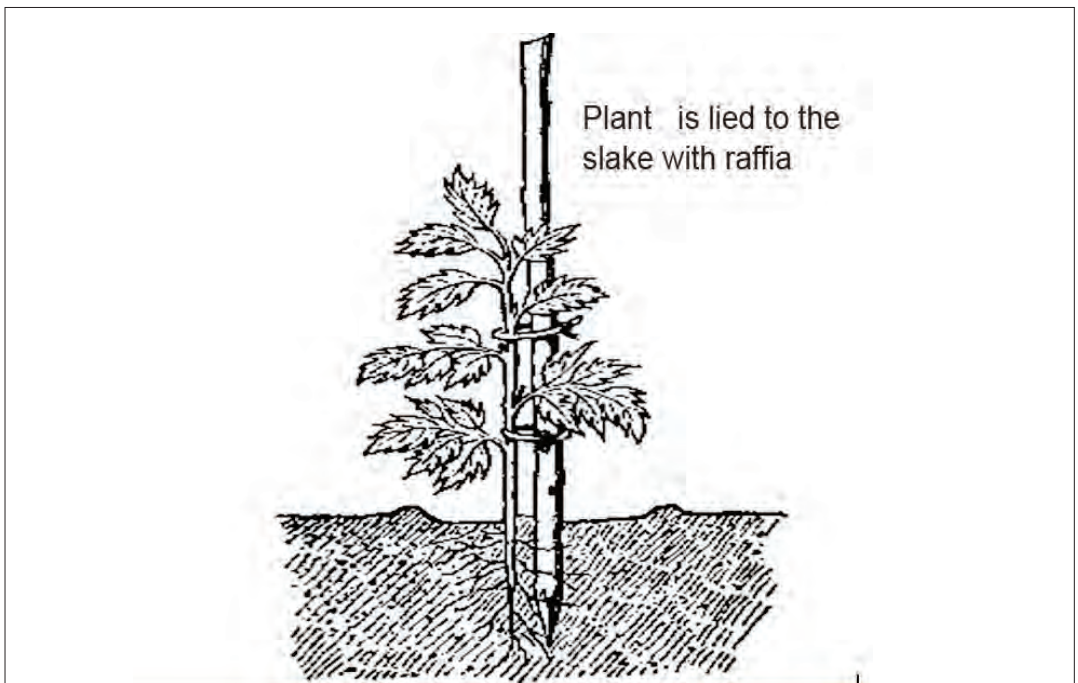

Fig 30. Staking of tomato plant

Cultivation and earthing up

Cultivation is performed for the purpose of improving aeration and the structure of the soil, facilitating the penetration of water and removing weeds, which will compete with the crop for water, light and nutrients. The other function of cultivation is to move soils towards plants planted near the edge of the bed. It consists in moving the surface layer of the soil without turning it. About three such operations are required to bring plants to the centre of the bed before the shoots start to hang into the furrows. Earthen up in the case of tomato can be used to support the crop or to stimulate development of adventitious roots from the stem. Therefore, first round earthen up activity is done during fertilizer application, approximately 45 days after transplanting and the second round earthen up could be done before flowering.

Pruning

Tomato plants grow very quickly and develop many branches, and then the fruits come late and are small. Therefore, pruning is important in order to control the apical dominant growth of the plant and initiate the development of limited stems on one plant for better fruiting. Pruning is also important to facilitate staking and tying up by cutting down the number of stems per plant. However, it should be noted that pruning to a single stem would speed up the maturity of the plant by a week or two, but at the expense of yield. Therefore, care should be taken in deciding how many stem to leave per plant based on the specific condition of the area. Usually, pruning to leave 2-3 stems is ideal for better fruiting capacity and also gives better foliage coverage to protect the fruits from the sun. A common and effective pruning method is to let one or two suckers grow out from near the plant's base to form a 2- 3-stem plant as it is indicated in fig. 31.



Fig 31. Tomato plant with shoots showing the parts to be pruned

Pruning on tomato plants can be applied following the procedures mentioned hereunder: (1) Remove the shoot; (2) Remove the buds which show between the leaf and the stem; (3) Keep only one or two main stems with their leaves and flowers; (4) Pruning should be carried out once or twice in a month; (5) With quick- growing varieties keep only 1 stem, but with slow- growing varieties keep 2 stems; (6) Do not prune before the tomato plant has two flowers and one leaf above the 2nd flower; (7) Cut the top of the stem above the leaf and two shoots will form, then leave one or both of the two depending on growing habit of the variety; (8) The bud develops into a new stem; and (9) Wait until two flowers form on the stem and then cut it back in the same way as it was done on the first stem.



Fig 32. Tomato plants with removed shoots

Mulching

- Cover the soil between the plants with cut herbage or leaves to keep the soil moist and depress weed growth, particularly in areas with water scarcity;
- It avoids dirtying of the leaves and fruits during watering;
- The mulch must not be too thick, in order not to affect breathing of the soil.

Water requirements

The total water requirement of the crop grown in the field for 90- 120 days after transplanting is about 400- 600 mm depending on the climate. The plant produces flowers from bottom to top during the active development of the stem. Fruit can be harvested while the plant is still flowering at the top. In some cases three flowering periods related to three harvests can be distinguished. However, for mechanical harvesting where the fruits are used for tomato paste, only 1 picking is required. Water supply needs to be adjusted according to the product, e.g. for paste or for fresh consumption. In this regard, the highest yields of salad tomatoes are obtained by frequent, but light irrigation is more appropriate with the last irrigation applied long before harvest. The crop is most sensitive to water deficit during and immediately after transplanting and during flowering and then followed by yield formation. Water deficit during the flowering period, causes flower drop. Moderate water deficit during the vegetative period enhances root growth. For high yield

and good quality of produce, the crop needs a controlled supply of water throughout the growing period. Whereas, under water limiting conditions some water savings may be made during the vegetative and ripening periods, water supply should be preferably be directed toward maximizing production per hectare rather than extending the cultivated area.

Water uptake

The crop has a fair deep root system and in deep soils it penetrates up to some 1.5m. The maximum rooting depth is reached after 60 days of transplanting. Over 80% of the total water uptake occurs in the first half to 0.7m and 100% of the water uptake of full grown crops occurs in the first 0.7 to 1.5m. Under conditions when maximum evapotranspiration /ET_m/ is 5 to 6 mm/day, water uptake to meet full crop water requirements is affected when more than 40 of the total available soil water have been depleted.

Irrigation scheduling

The crop performance is sensitive to the irrigation practices. In general, a prolonged severe water deficit limits growth and reduces yield, which can't be corrected by heavy watering later on. Highest demand for water is during flowering. However, withholding irrigation during this period is sometimes recommended to force less maturing plants into flowering in order to obtain uniform flowering and ripening. Excessive watering during the flowering period, however, has been shown to increase flower drop and reduce fruit set. In addition, excessive watering may cause excessive vegetative growth and a delay in ripening. Water supply during and after fruit set must be limited to a rate, which will prevent stimulation of new growth at the expense of fruit development.

Heavy, irregular irrigation or dry periods alternating with wet periods should be avoided. For production of salad tomato as with more than one harvest, the crop flourishes best under light, but frequent irrigation, well distributed over the growing period with the soil depletion level during the different growth periods remaining below 40 percent. This promotes optimum growth during the total growing period and results in high yield of good quality of fruit. When water supply is limited, application for a salad crop can be concentrated during periods of transplanting, flowering and yield formation. Irrigation frequency will vary according to soil type and weather conditions in the range of 7 to 15 days. Therefore, apply irrigation water every 4-5 days for the first 4 weeks and every 7 days then after. In general, more frequent irrigation is required on light sand soils than on soils having a high clay fraction. Frequent, but light irrigations improve the size, shape, juiciness and colour of the fruit, but total solids /dry matter content/ and acid content will be reduced. However, the decrease in solids will lower the fruit quality for processing. In selecting the irrigation practices consideration must, therefore, be given for the type of end product required. Prolonged water deficits during yield formation period interrupted by heavy irrigation leads to fruit cracking and splitting of the fruit skin.

Irrigation methods

The most common method of applying irrigation water is using furrow irrigation method running between raised beds of plants. Sprinkler irrigation is suitable at early stage for better germination for direct seeded tomato and then after the crop established better to use furrow

irrigation. Sprinkler irrigation is not preferred at latter stages of crop development and maturity, due to occurrence of fungal diseases and possibly bacterial canker may become a major concern. Further, under sprinkler irrigation fruit set may reduce, due to an increase in fruit rotting. When irrigating tomato field care should be taken not to pour water on the leaves and fruits in order to avoid tomato blight development. In the case of poor quality water, leaf burn will occur with sprinkler irrigation, sprinkling at night and shifting sprinkler lines with the direction of the prevailing wind may reduce this problem. When fruit rot is a problem frequent sprinkler irrigation should be avoided during the yield formation period. However, drip irrigation could be successfully applied under tomato crop.

CROP PEST CONTROL

Very serious crop losses occur in tomatoes through failure to control diseases and pests. Many diseases of tomatoes are, particularly difficult to control during the rainy season. Therefore, it is recommended to produce tomato during the dry season under irrigation to minimize the risk of disease infestation and reduce related yield losses.

• Disease Control

Many diseases attack roots, stems, leaves and fruits of tomato plant. The major diseases attacking tomatoes are: early blight /*Alternaria solani*/ and late blight /*Phytophthora*/, septoria leaf spot /*Septoria lycopersici*/, powdery mildew /*Leveillula taurica*/, bacterial and Fusarium wilts.

Early blight / *Alternaria solani*/- it is a fungus disease.

Symptoms: Three different phases of the disease are found on tomatoes. These are: (a) On young plants in the seedbed the disease causes a canker and collar rot, elongated spots on the lower stem; (b) On the leaves- brown zoned spots, up to 8 mm diameter, surrounded by a yellow halo: The stem and leaf axils may also be attacked and the plant may partly defoliate and reduce the yield with reduced quality; (c) On the fruit- large, often-zoned spots up to 2 cm diameter and often on the upper side of the fruit and may cause the dropping of the blossom or the young fruit.

Damage: There is a loss of young plants in the seedbed, in addition, the danger of spreading disease on transplants. The fungus is seed- borne.

Septoria leaf spot / *Septoria lycopersici*/:

Symptoms of Septoria leaf spot: Small black spots on the leaves, increasing in size and becoming gray with a black margin and with minute black pycnidia embedded in the tissue of the spot. The spots are smaller and more numerous than those of early blight. If the spots are very numerous the leaflet dies and drops off. Usually, infection takes place first on the older leaves near the ground and progress rapidly under favourable conditions until a few leaves are left at the end of the stem. Temperature of above 25°C associated with very high humidity favoured the development of the fungus.

Symptoms of powdery mildew: The most common symptoms of powdery mildew on tomatoes

are light green to bright yellow lesions on the upper leaf surface. Necrotic spots sometimes with concentric rings similar to those early blight lesions may develop in their centres. Under conditions favourable for disease development abundant powdery develop on the upper and lower leaf surfaces.

Late blight

Late blight is highly destructive disease affecting tomato. The disease is very serious on tomato, particularly where the weather is constantly cool and rainy. It is caused by the Phycomycete fungus called *Phytophthora infestans*. The pathogen survives between cropping seasons in association with volunteer and abandoned potato and tomato plant materials in the field. It is most active during cool, moist weather. Cool nights and warm days are ideal for late blight development. Inoculation produced on infected plant materials that remain from previous crops is carried by wind to other plants.

Symptoms of late blight: the fungus attack all above ground parts of the tomato plants. Leaf lesions first appear as indefinite, water soaked spots, which may enlarge rapidly in to pale green to brown lesions and over large areas of the leaf. Infected foliage becomes brownish, shrivels and soon dies. Other parts of plants are affected in a similar manner so the whole plant may die. Decaying may be recognized by full odour that pervades the air. The following are the recommended practices for the control of different diseases on tomatoes: (1) Seed treatment with fungicides; (2) Use disease free seeds and resistant varieties for planting; (3) Rouging of infected plants and burying them deeply in the soil; (4) Seed should be sown in correctly- spaced line and watering of young plants in the seedbed should be completed before late afternoon so that they do not remain wet overnight; (5) Following a four year crop rotation cycle with cereals and pulses and do not grow tomatoes next to cucumbers, potatoes or tobacco, which may have the same diseases; (6) For the control of blight spray with 3 kg/ha rate of ridomyl (0.23%) or maneb or zineb by mixing with 500 litres of water immediately after the disease is observed and spray in a week interval;

Insect pest control

Tomato fruitworm or cotton bollworm /*Heliothis armigera*/, leafhopper, whitefly /*Bemisia tabaci*/, cutworms and stinkbugs are the major insect pests that attack tomato very seriously.

Damage: Leaves are damaged and flower- trusses are cut off, but the most serious damage is that caused by penetration of the fruit by the caterpillar of tomato fruit worm, which may destroy several fruits in succession. When fruits are attacked in the very young stage they generally fall down. For the control of Tomato fruitworm or cotton bollworm the following alternatives could be taken into account: (1) Deep ploughing and exposing the eggs and pupae to their natural enemies and unfavourable weather conditions; (2) Destroying plants that serve as alternative food sources; (3) Spraying with 2 l/ha of endosulfan 35 % E.C or 1.5 kg/ha of carbaryl 85 % W.P; (4) Endosulfan 25 % U.L.V 3 litres per hectare directly without mixing with water; (5) 50- 70 g per hectare of cypermetrin 10 % E.C mixing with 500 lit. of water. The spraying should be performed before flowering and ripening of fruits.

Nematodes: Tomatoes are especially susceptible to root knot nematodes. The nematode induces the development of irregular swelling or knots on the roots. The water and nutrients uptake from the soil is distributed and the plant develops poorly. For the control of nematodes: Use resistant varieties, roughing of infected plants, destroying plant residues after harvest, keeping crop rotation.

HARVESTING

- Tomato will be ready for picking after 80- 100 days of transplanting depending on the cultivated variety and climatic conditions of the area;
- For immediate use such as for fresh home consumption it is possible to pick up ripen fruits;
- Whereas for fresh marketing the fruits should be picked up before they are fully ripen, but for local markets, pick at the hard ripe to pink stage;
- For processing purpose / canning and paste/ it is important to pick up the fruits at their full maturity stage- when they are ripe, red all over;
- It is important that mature tomatoes should have a high content of total soluble solids /TSS/. The minimum TSS of fruit normally accepted by a processing plant is 5 %;
- The longer the fruits can be left on the vine, the higher the quality;
- It is also important not to damage the skin of fruits during harvesting and transportation;
- Do not piling too many of them on top of each other;
- It is best to pick up tomatoes during the day, because wet tomatoes are not keeping well;
- Keep out the harvested fruits of sun; ripen best in dark;
- All diseased or insect- damaged fruit should be discarded during picking;
- Varieties with thin skin and oval fruit shape are preferable for long distance market; whereas varieties with circle shaped fruits are cultivated for home consumption and nearby local markets.



Fig. 33. Ripen tomato fruits ready for harvest

Post-harvest handling: It includes grading, packing and storage. Grading should be done on the basis of size, shape, stage of maturity and other characteristics such as clean lines, freedom from diseases, insect or mechanical damage free of foreign material.

3.2.3 PEPPER /*Capsicum annum*/

CROP DESCRIPTION AND ITS USE

Pepper is thought to originate from tropical America. Most of the peppers grown in most of the areas belong to *C. annum*, but the small pungent peppers belong to *C. frutescens*. Hot pepper is extensively being used and it is a very well known diet in Ethiopian dish. The crop has great economic importance in the traditional dish in the form of fresh green pepper as vegetable and after full maturity as a spice for food flavouring. Hot pepper with a high content of capsaicin makes the fruit very pungent. It is also used industrially in the dry state for production of colour oleorescon by a solvent extraction process and used for export. Therefore, pepper is economically important crop both for home consumption and for marketing and it is one of the most important crops for cash generating to farmers.

VARIETIES

Hot pepper varieties recommended are Bako local and Marako Fana. However, in the absence of improved varieties, it is also possible to use local varieties that are widely adaptable and with promising yield potential. The varietal characteristics of Bako local are; red with thin skin, highly pungent and the size slightly less than Mareko Fana. It is short maturing variety as compared to Mareko Fana. But the variety Mareko Fana characterized by deep red colour of the fruit, long fruit, and thick skin and pungent as well. Due to thick skin this variety is, particularly suited for processing plants of spices.

Table 32. Characteristics of recommended varieties of pepper

Variety	Altitude (m)	Rainfall (mm)	Maturity (days)	Pod characteristics	Productivity, Qt/ha		Production status
					Research	Farmers field	
Mareko Fana	1200-2100	900-1300	220- 240	Dark red pungent	15- 25	9- 11	Under produc- tion
Bako Local	1200-1900	800-1300	130- 145	Light red pungent	20- 25	10- 12	Under produc- tion

SOIL AND CLIMATIC REQUIREMENTS

Soil

Light- textured fertile and well-drained soils with a high level of organic material and adequate reserves of essential elements and adequate water-holding capacity are preferable. Good drainage is important, since waterlogging is likely to cause leaf drop. Plants are slightly tolerant to acidic soils but a pH of 5.5 to 7 is optimum.

Temperature

Pepper thrives best in climates with growing season temperatures in the range of 20 to 27 °C during the day and 15 to 20 °C during the night. Lower night temperatures result in greater branching and more flowers, while warmer night temperatures induce earlier flowering and this effect is more pronounced as light intensity increases. Excessive hot weather may produce infertile pollen and reduce fruit set. The optimum growing temperatures are, however, 21 to 29 °C for the hot peppers and 21 to 24 °C for the sweet pepper.

Altitude and rainfall

Pepper is growing below 2200 m above sea level, but best suited altitude ranges between 1400 and 2000 m above sea level. The crop is extensively growing under rainfed conditions and high yields are obtained with rainfall of 600 to 1250 mm, well distributed throughout the growing period. However, the crop can also be grown successfully under irrigation, particularly of sweet pepper.

RECOMMENDED IRRIGATION AGRONOMIC PRACTICES

Seedbed preparation and sowing

In addition to the recommended practices discussed under general consideration for vegetable growing the following need to be undertaken under pepper: (1) Preparing the seedbed using mixed soils in a ratio of 3:2:1 soil, manure and pure sand; (2) The total area required to raise seedlings sufficient for 1 ha is 300 m²; (3) The distance between beds is 40- 50 cm; distance between rows on the seedbed is 15 cm and the distance between plants when it is sown on seedbeds is from 2 to 4 cm; (4) A total of 600 g of seeds/ha are required and a depth of 0.5- 1 cm should be maintained for sowing.

Land preparation

- The permanent field should be ploughed frequently and leveled, then make furrows or ridges by maintaining 75 cm distance between rows;
- Plant spacing is 75 cm between rows and 25 cm between plants;
- Irrigate the field a day before transplanting;
- The field must not be covered with the same crop or related species for the last 3- 4 years;
- Transplanting should be carried out in the morning hours or late in the afternoon hours;
- Apply irrigation water immediately after transplanting.

Time of planting

Under rainfed condition during the main rainy season it is necessary to plant pepper starting from mid of April to first half of May. However, under irrigation condition it will be very important to plan planting of pepper by taking into consideration factors such as; season of high market demand, harvesting period for the main season crops and frost free periods.

Transplanting

- Seedlings of 15 to 20 cm are transplanted in the field, this is coinciding with 25 to 35 days after sowing at nursery beds or 6- 7 weeks time /approximately 55- 60 days after sowing/;
- Prior to transplanting, seedlings need to be hardened;
- Seedlings are sometimes topped 10 days before transplanting to encourage branching.

Planting

Under rainfed condition the planting distance will be 60 cm between rows and 40 cm between plants. Under irrigation condition, it is planted in double rows on flat-topped ridges. The distance between rows will be 80 cm and 40 cm between plants. Double row spacing is 40 cm and the spacing between double rows is 80 cm. Spacing within the row is 40 cm. Plant population estimate

per hectare is about 42, 000 plants. Three to five years should elapse before planting pepper on the same field in order to avoid the build up of insect pests and diseases and reduce their attack.

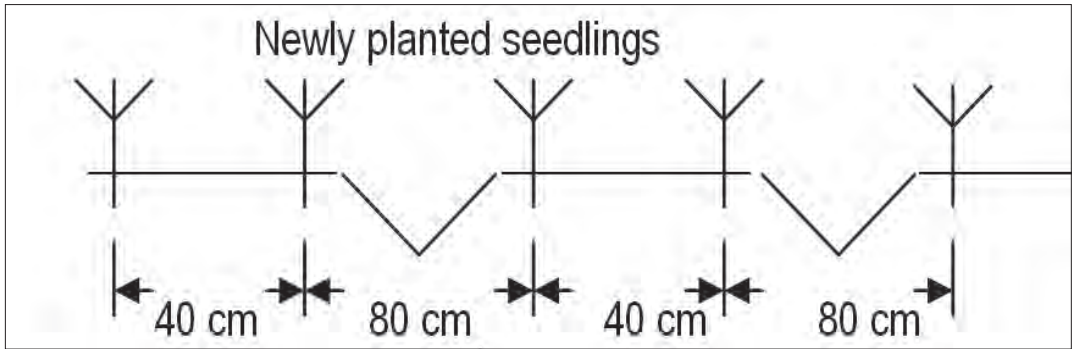

Fig. 34. Planting system of onion on the top- flat beds in double rows

Weed control

Pepper is susceptible to weed competition, particularly at the early stages of growth. Therefore, the field should be free of weeds. The first weeding will take place after 20 days of transplanting and the second one after 40 days. It is also important to weed the field at least once just before flowering.

Fertilizer application

- Apply 100 kg/ha of DAP during land preparation;
- Split application of 100 kg/ha of Urea is recommended. The first will be applied after 20 days of transplanting and the second half at flowering and incorporate with the soil immediately;
- If the soil is so fertile, application of Urea may not be required;
- Irrigate the field after fertilizer application;
- Recommended to use decomposed compost or well rotted manure.

Water requirements

The total water requirements are 600 to 900 mm and even sometimes up to 1250 mm for long growing varieties and for several pickings. For high yields, an adequate water supply and relatively moist soils are required during the total growing period. Irrigation water supply shortage during the growing period in general has an adverse effect on yield and the greatest reduction when there is a continuous water shortage until the time of first picking. In particular, the period at the beginning of flowering period is most sensitive to water shortage and soil water depletion in the root zone during this period should not exceed 25 %. Water shortage just prior and during early flowering reduces the number of fruits. The effect of water deficit on yield during this period is greater under conditions of high temperature and low humidity.

Irrigation scheduling

For optimum yield levels the soil water depletion in most climates should not exceed 30 to 40 % of the total available soil water. Due to low depletion level light irrigation applications are required. Irrigation frequencies of 5 to 7 days interval are common, particularly in the early growth stages but at latter growth stages it might extend up to 7 to 10 days interval. When there is a water supply shortage, irrigation should preferably be adequate up to the first picking and water savings may be made thereafter. Controlled irrigation is essential for high yields because the crop is sensitive to both over and under irrigation. Water deficit during yield formation period leads to shriveled and malformed fruits. Pepper has a tap root system, which is broken at the time of transplanting and profusely branched lateral root system subsequently develops. Root depth can extend up to 1.0 m but under irrigation condition roots are mainly concentrated in the upper 0.3 m soil depth. Normally 100 % of the water uptake occurs in the first 0.5 to 1.0 m soil depth.

Irrigation method

Pepper is grown under surface, sprinkler and drip irrigation methods. However, considering the Ethiopian condition the commonly used and recommended method of irrigation for pepper is the furrow method.

CROP PEST CONTROL

Disease control

Different plant diseases attack pepper. Bacterial leaf spot /*Colletotrichum capsici*/, *phytophthora*, powdery mildew /*Leveillula faurica*/, bacterial wilt /*Pseudomonas solanacearum*/, anthracnose /*Colletotrichum nigrum*/ and mosaic virus are among the major diseases that attack pepper.

Symptoms of powdery mildew: chlorotic blotches on the upper side of the leaf and powdery blotches on the lower side. The recommended control measures are: (1) use disease free seeds for planting; (2) use disease resistant varieties; (3) keep strictly a 4 year cycle of crop rotation with cereals, pulses and fodder crops; not planting pepper after eggplant, tomato and potato on the same field within 2- 4 years time; (4) avoid host plants that serve for disease transmission; (5) rough out infested plants and buried them; (6) avoid contamination and wounding of fruits; (7) for leaf spot or phytophthora spray copper oxychloride 0.5 % 50g /ha mixed with 10 litre of water; (8) for controlling of powdery mildew spray with kocide 0.2 % 20g mixed with 10 litres of water.

Insect pest control

Aphids, leaf miners, cutworms, fruitfly, false codling moth, *Heliothis armigera* and lesser armyworm are among the major insect pests that attack pepper. Damage of fruit fly: Infected fruits often contain several maggots, and usually rot and drop prematurely and substantial losses can be occurred. The control methods are: Developing maggots with the infested fruits can be collected and killed, as soon as attacks are observed apply sprays of dimethoate, malathion, or trichlorophon, but during the harvesting period use only malathion and/or trichlorophon.

Harvesting

- For using as fresh food it can be harvested when the fruit is fully developed and still green;
- For dry or hot pepper it is important to harvest fully matured and reddish pepper;
- Pepper as a fresh food is not possible to store for long time, therefore, recommended to use it immediately for home consumption or marketing;
- Fully matured and picked pepper can be kept in the field on well-prepared clean area for sometimes in order to dry it completely;
- Mareko Fana under improved production system it can yield up 15- 20 qt/ha;
- Bako Local under research condition- 20- 25 qt/ha and under farmers condition- 10 qt/ha, whereas in the form of fresh product it can be obtained about 200 qt/ha.

3.2.4 Cabbage (*Brassica oleracea var. capitata*)

CROP DESCRIPTION AND ITS USE

Cabbage (*Brassica oleracea var. capitata*) originates from the south and western coast of Europe. The annual world production is about 55 million tons of fresh heads from 2.6 million ha (FAOSTAT, 2001). Cabbage is a cool season crop and one of the oldest vegetable crops grown in the temperate regions but gradually distributed throughout the world where climatic conditions are found favourable for its successful growing. Therefore, cabbage is considered and has been domesticated and used for human consumption since the earliest antiquity. Cabbage is considered as one of the most popular vegetables grown successfully in high and mid altitude areas of Ethiopia, in most cases under subsistence farmers.

Cabbage is a dicotyledonous biennial crop, but is grown as an annual crop. There is much variations in cabbage types, ranging in colour from green to purple; in leaf character from smooth to savoy leaves; in head shape from flat to pointed and in maturity from early to late maturity. The green, round headed types are the most common and widely distributed variety in the world.

Cabbage is characterized by slow development during the first half of the growing period, which may be 50 days for early maturing and up to 100 for autumn-sown, late maturing varieties (establishment and vegetative periods). However, during the yield formation and ripening periods the plant doubles its weight approximately every 9 days over a total period of 50 days. In the beginning of the yield formation period, head formation starts, followed by a sudden decrease in the rate of leaf-unfolding but gradually the leaf- unfolding will cease completely, while leaf initiation continues. This results in the formation of a restrictive skin by the oldest folded leaves within which younger leaves continue to grow until the firm, mature head is produced during the ripening period. Depending on variety, the head can be pointed or round, green or red.

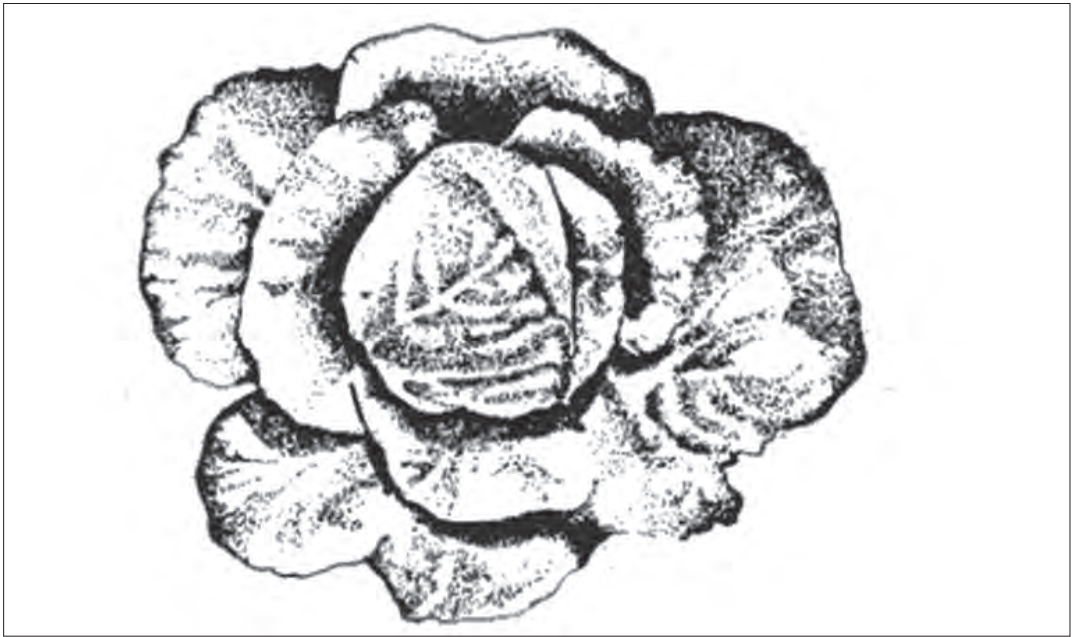

Figure 35. Cabbage with round head (the most common type)

In 100 g edible portion of cabbage contains 1.8 g protein, 0.1 g fat, 4.6 g carbohydrate, 0.6 g mineral, 29 mg calcium, 0.8 g iron and 14.1 mg sodium. Moreover, it is a rich source of vitamin A and C. It may be served in slaw, salads and cooked dishes and can be served with other traditional dishes.

VARIETIES

Of course, limited varieties of cabbage are either introduced and/or developed in Ethiopia. Of the most widely distributed varieties of cabbage can be sighted Copenhagen Market and Early drumhead. Copenhagen Market variety is characterized by its roundhead, the leaves are dark green, the length of growing period is on average 110 days, even though it depends on the temperature of the area whereas early drumhead is characterized with somewhat flat on the top, the leaves have light green colour and the variety will take about 90 days to full maturity.

Copenhagen Market variety is usually grown relatively in higher range of altitudes (500 – 3000 m a.s.l) and with better yield potential of 27.5 t/ha, whereas early is being grown in Ethiopia in a range of altitudes (500 – 1700 m a.s.l) and gives an average yield of 15.8 t/ha.

SOIL AND CLIMATIC REQUIREMENTS

Soil

Cabbage can be generally grown more successfully in heavier loam soils, which are considered more suitable for cabbage production. Soils rich in soil organic matter and easy for free air movement are more suitable. Under high rainfall conditions, sandy or sandy loam soils are preferable because of improved drainage. Cabbage is not performing well in waterlogged condition, where soil air movement is restricted and consequently soil nutrient uptake will be affected. The nutrient

requirement of cabbage is high relative and sometime it can be in a range of 100 to 150 kg/ha N, 50 to 65 kg/ha P and 100 to 130 kg/ha K.

Cabbage is moderately sensitive to soil salinity. Yield decrease due to soil salinity at different levels of ECe is: 0% at ECe 1.8, 10% at 2.8, 25% at 4.4, 50% at 7.0 and 100% at ECe 12.0 mmhos/cm. The most appropriate soil pH is in a range of 6.5 to 6.8.

Temperature

Cabbage thrives best for high production during cool, moist season and the crop requires a cool, humid climate. The length of the total growing period varies between 90 and 200 days, depending on climate, variety and planting date, but for good production the growing period is about 120 to 140 days. Most varieties can withstand a short period of frost of -6°C, some down to -10°C. Long periods (30 to 60 days) of -5°C are harmful. The plants with leaves smaller than 3 cm will survive long periods of low temperature but when the leaves are 5 to 7 cm, the plant will initiate a seed stalk and this leads to a poor quality yield. Optimum growth occurs at a mean daily temperature of about 17°C with daily mean maximum of 24°C and minimum of 10°C. Mean relative humidity should be in the range of 60 to 90 percent.

Rainfall/moisture

Cabbage is successfully grown with an average rainfall of 450 mm during the growing season and if it is grown during the dry season the water requirement of the crop should be supplied through irrigation. Therefore, adequate supply of water either in the form of rainfall or through irrigation needs to be maintained in order to satisfy the crop water requirement at different growth stages.

Production method

Planting can be done by direct seeding with a seed rate of 3.5 kg/ha, or by transplanting to open field from seedbeds and from cold frames which are used to protect the crop from cold during germination and early plant development. However, direct seeding is not common and not a recommended practice in Ethiopia. If direct seeding is practiced, it may require thinning out seedlings to maintain the recommended spacing. At the same time good land preparation is essential. In direct sowing the young plants are more susceptible to be damaged by heavy rains and winds. Direct sown cabbages are requiring to be irrigated regularly as compared with row planted cabbage. Instead, cabbage is successfully produced through seedling preparation and then transplanted to the permanent field. Therefore, healthy seedlings need to be prepared carefully at seedbeds to get high quality produce, which is suitable for open marketing.

RECOMMENDED IRRIGATION AGRONOMIC PRACTICES

Seedbed preparation and sowing

In addition to the recommended practices discussed under general consideration for vegetable growing the following need to be undertaken under cabbage like other vegetable crops: (1) Preparing the seedbed using mixed soils in a ratio of 3:2:1 soil, manure and pure sand; (2) The total area required to raise seedlings sufficient for 1 ha is 300 m²; (3) The distance between beds is

40- 50 cm; distance between rows on the seedbed is 15 cm and the distance between plants when it is sown on seedbeds is from 2 to 4 cm; (4) A total of 350 g of seeds/ha are required and a depth of 0.5- 1 cm should be maintained for sowing.

Land preparation

- The permanent field should be ploughed frequently and leveled, then make furrows or ridges by maintaining 60 cm distance between rows;
- Plant spacing is 60 cm between rows and 40 cm between plants;
- Irrigate the field a day before transplanting;
- The field must not be covered with the same crop or related species for the last 3- 4 years;
- Transplanting should be carried out in the morning hours or late in the afternoon hours;
- Apply irrigation water immediately after transplanting.

Time of planting

Under rainfed condition cabbage needs to be planted during the main rainy season starting from end of June or early July onwards. However, under irrigation condition it will be very important to plan planting of cabbage by taking into consideration factors such as; season of high market demand, harvesting period for the main season crops and frost free periods. In this regard, it is strongly recommended to plant cabbage after the frost period is over and in most cases it will be suitable to plant it from January onwards, which is considered as frost free period. However, seedlings need to be prepared ahead. The seedlings will be ready for transplanting to the permanent field when they reached the height of 10 – 15 cm.

Transplanting

- Seedlings of 10 to 15 cm are transplanted in the field, this is coinciding with 20 to 30 days after sowing at nursery beds or 6- 7 weeks time /approximately 50- 55 days after sowing/;
- Prior to transplanting, seedlings need to be hardened;
- Seedlings are sometimes topped 10 days before transplanting to encourage branching.

Planting

Row spacing is dependent on the size of heads required for markets or between 0.3 and 0.5 m for heads of 1 to 1.5 kg each and 0.5 and 0.9 m for heads up to 3 kg each. An optimum production can be reached with a plant density in the range of 30000 to 42000 plants/ha.

Under rainfed condition the planting distance will be 50 cm between rows and 40 cm between plants. Under irrigation condition, it is planted in double rows on flat-topped ridges. The distance between rows will be 60 cm and 40 cm between plants. Double row spacing is 40 cm and the spacing between double rows is 60 cm. Spacing within the row is 40 cm. Plant population estimate per hectare is about 42, 000 plants.

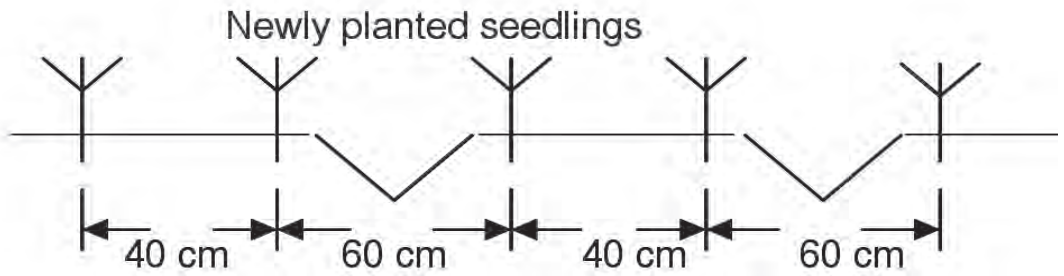

Fig. 36. Planting system of cabbage on the top- flat beds in double rows

Weed control

Cabbage is susceptible to weed competition, particularly at the early stages of growth. Therefore, the field should be free of weeds. The first weeding will take place after 20 days of transplanting and the second one after 40 days. It is also important to weed the field at least once just before complete heading.

Fertilizer application

- Apply 150 kg/ha of DAP during land preparation and 50 kg/ha of urea in soils with good fertility;
- However, if it is grown in more degraded soils then it is recommended to use 200kg/ha of DAP and 100 kg/ha of urea in split application is recommended. The first half of urea will be applied at planting and the second half needs to be applied after a month period of time and advised to incorporate the fertilizer with the soil immediately after it is applied;
- Irrigate the field after fertilizer application;
- Recommended to use decomposed compost or well rotted manure.

Water requirements

Water requirements vary from 380 to 500 mm depending on climate and length of growing season. The crop transpiration increases during the crop growing period with a peak towards the end of the season. In relation to the reference evapotranspiration (ET_o), the crop coefficient (k_c) for cabbage is: during the initial stage 0.4-0.5 (20 to 30 days); the crop development stage 0.7-0.8 (30 to 35 days); the mid season stage 0.95-1.1 (20 to 30 days), the late season stage 0.9-1.0 (10 to 20 days); and at harvest 0.8-0.95.

Cabbage has an extensive shallow root system. The majority of the roots are found in the upper soil layers at a depth of 40 – 50 cm of the soil with a rapid decrease in root density. Actually, 100 per cent of the water is extracted from this layer ($D= 0.4$ to $0.5m$). Under conditions when $ET_m = 5$ to 6 mm/day, the rate of water uptake by the crop starts to reduce when the available soil water has been depleted by about 35 percent ($p = 0.35$). Therefore, particularly under dry irrigation season the crop needs to be supplied with irrigation water more frequently but with light irrigation. Depending on the climatic condition, soil type and the growth stage of the crop it is recommended to irrigate within the range from 3 to 12 days intervals.

Irrigation scheduling

For optimum yield levels the soil water depletion in most climates should not exceed 30 to 35% of the total available soil water. Due to low depletion level light irrigation applications are required. Depending on climate, crop development and soil type, the frequency of irrigation varies between 3 and 12 days. Irrigation frequencies of 3 to 7 days interval are common, particularly in the early growth stages but at latter growth stages it might extend up to 7 to 12 days interval. If available water supply is limited, early irrigations should not be practised unless these can be continued until the end of the crop growing period. Water savings should preferably be made in the beginning of the crop growing period. Water deficit during head formation period leads to shriveled and malformed heads. Root depth can extend up to 0.5 m but under irrigation condition roots are mainly concentrated in the upper 0.3 m soil depth.

Irrigation method

Cabbage is grown under surface, sprinkler and drip irrigation methods. However, considering the Ethiopian condition the commonly used and recommended method of irrigation for cabbage is the furrow method.

CROP PEST CONTROL

Disease control

Different plant diseases attack cabbage. Of which black rot, caused by *Xanthomonas campestris* pv. *campestris* is a very destructive disease of crucifer species. Black rot has been a major disease constraint of cabbage production to smallholder farmers in Ethiopia like in any other African countries where substantial crops losses are experienced, especially during the warm and wet seasons.

Insect pest control

Aphids, leaf miners, cutworms and *Heliothis armigera* are among the major insect pests that attack cabbage. The control methods are: destroying of crop residues and preparation of land during the dry season which will expose eggs and larvae of insects to be exposed to the sun, maintain crop rotation cycle and as soon as insects are observed than the threshold it is recommended to control by applying sprays of the recommended insecticides such as dimethoate, malathion, or trichlorophon, but towards the harvesting period it is recommended to use only malathion and/or trichlorophon.

Harvesting

- The proper time for harvesting is when the head firm and fully matured;
- Cabbage as a fresh food is not possible to store for long time, therefore, recommended to use it immediately for home consumption or marketing;
- Cabbage with well-matured head under rainfed conditions, yields of 25 – 35 ton/ha fresh heads are normal, this can be increased to 50ton/ha under well-fertilized field and good management practices. Under ideal climatic conditions and good irrigation and crop management practices the cabbage yield can increase as high as 85 ton/ha.
- The water use efficiency for harvested yield for heads is about 12 to 20 kg/m³.
- The average water content of cabbage is about 90% with a high vitamin B, C, calcium and phosphorus content. Smaller heads of poor quality are produced under limited water supply, particularly during the last growth stage- head formation and development.

4. TUBER CROPS

4.1 POTATO /*Solanum tuberosum* -L./

IMPORTANCE OF THE CROP AND ITS USE

Potato is thought to have originated in the highlands of tropical and subtropical regions of South America /currently known as Bolivia and Peru/. Potato is one of the most important agricultural crops and it is being grown worldwide as a main source of carbohydrate next to rice, wheat and maize. The average composition of the potato tuber is about 75 to 78 % water, 1.8 to 2.0 % of high quality protein, 17 to 20 % carbohydrates, 1.2 % fibre, 1.0 % ash, and less than 1.7 % fat. It is low in calcium but fairly high in phosphorus. Of the vitamins, it has substantial content of ascorbic acid, riboflavin, niacin and thiamin. Nutritionally, potato is perhaps the most balanced of the major food crops and it provides calories and protein in proportion to adult human requirements. Potato proteins are somewhat deficient in the amino acids of methionine and cystine. However, it ranks next to soybeans and are superior to the cereals in total protein production per hectare.

In Ethiopia potato is being cultivated in different parts of the country, since the 19th century, mainly in mid and high altitudes, initially as a garden crop but currently, it is also considered as the main field crop. It is being growing mainly for home consumption and the main source of cash for the highlanders as well. In most parts of potato growing areas, potato is being growing mainly by rainfed agriculture. In this relation excess production supply is evident during the main season that leads to low crop price and as a result the farmers are not getting attractive market prices for their produce. In areas, where there is irrigation water, potato is, therefore, advised to be cultivated during the dry season and then the farmers may have the opportunity to get better market price.

Potato is a crop that has different uses. It is in particular, an important product for food purpose to the people and even sometimes it is called as the second bread. Potatoes have a high degree of acceptance as food in all countries where the crop is grown. Potato tuber is used for meals in so many different ways. It is very common in the European kitchen to prepare more than 200 different types of food items from potato. Even in Ethiopia it can be utilized as a food in different ways. Potato tuber is an excellent raw material for production of different kinds of high value industrial products such as for the preparation of alcohol, glucose and in Ethiopia; in particular it is used even for preparation of some local drinks, such as distilled liquor, which is locally called "Areki". Furthermore, potato plays an important role in food processing industries. The leftover from potato is a good source of fodder for cattle. From agronomic point of view, potato is considered as an important preceding crop in crop rotation for wheat, maize and grain pulses that reduces the problem of weed and incidence of diseases.

VARIETIES

The recommended varieties of potato and altitude ranges are indicated in Table 33 below.

Table 33. Major potato varieties recommended for cultivation

Varieties	Altitude ranges, m	LPG days	Productivity qt/ha	Colour		Suitable areas for the variety
				Flower	Tuber	
Awash	1700 - 2800	90- 100	254 (200)	na	na	Areas with rfi > 750 mm
Menagesha	2200 - 3000	120- 130	270 (250)	Purple	Red/white	Mid and high alt.
Tolcha	1700 - 2800	100- 115	331 (180- 220)	White	Yellow	*
Chiro	1600 - 2000	75- 100	320-400 (250- 300)	Purple	White	West Hararghe potato growing areas
Alemaya- 624	1000 - 2000	90- 100	259	White	White	Susceptible to rust and preferred under irrigation
Guenet	1600- 2800	90- 100	275	White	White but reddish on the eyes	Rift Valley areas under irrigation
Degemegn	1600- 2800	90- 120	448 (291)	Purple	White	Mid and high alt.
Zengena	2000- 2800	105	300 (222- 250)	Purple	White	For potato growing areas of West Amhara
Guassa	2000- 2800	110- 115	224 (220- 250)	White	White but reddish on the eyes	For potato growing areas of West Amhara
Gorebela	2700- 3200	134- 159	301 (260- 300)	Red	White but reddish on the eyes and white underneath	Particularly suited to wet highland potato growing areas of north Shoa

Source: Holeta, Adet, Sheno Agricultural Research Centres and Alemaya University of Agriculture

SOIL AND CLIMATIC REQUIREMENTS

Altitude

Usually potato is growing in mid and high altitude areas, particularly in high altitudes it is considered as the main stable crop of the highlanders. Potato can be grown successfully in lowland areas as well under irrigation and promising results can be achieved. Best-suited altitudes ranged between 1500- 2800 m. However, for healthy tubers production, particularly for planting purpose, it should strictly be cultivated in high altitude areas. Potato is susceptible to frost damage and it should be grown at frost free periods.

Temperature

For normal tubers development and to obtain high tubers yield temperatures from 5 to 25 °C are more suitable. But optimum soil temperatures for normal tuber growth are from 15 to 18 °C during the growing period. In general, a night temperature of below 15 °C is required for tuber initiation and tuber growth is sharply inhibited when the temperatures are below 10 °C and above 30 °C. Temperatures from 20 to 29 °C lead to the development of small tubers.

Soil

Potato requires a well- drained, aerated and porous sandy loam or loamy sand soils with pH value of 4.5 to 7.5. Not recommended heavy clays and waterlogged soils. Potato is grown in 3 or more year rotation cycle with other crops such as maize, beans and fodder crops, in order to maintain soil productivity, control weeds and reduce crop losses, due to insect pest damage and diseases, particularly soil- borne diseases.

Rainfall/Moisture

For high yields, the total crop water requirements for a 120 to 150 days crop are about 500 to 700 mm, depending on the climate of the area. Potato is relatively sensitive to soil water deficit. To optimize yields the total available soil water should not be depleted by more than 30 to 50 per cent.

Production constraints

Major constraints to increased and extended production are the high cost of production, lack of cultivars adapted to specific conditions, diseases and pests damages and the need for improved post- harvest technologies for the diverse environments where potato is grown. The following are recommended improved irrigation agronomic practices to increase production and productivity.

RECOMMENDED IRRIGATION AGRONOMIC PRACTICES

Land preparation

One of the main conditions that allowed obtaining high yields of potato is formation of well prepared, aerated and with adequate moisture of soil. Land preparation, in addition to improving chemical and physical conditions of soil, it is useful to control weeds and expose eggs and pupae of insects and soil borne disease pathogens to sunshine and to their natural enemies. It is also useful to incorporate organic and inorganic fertilizers with the soil. Generally, the following land preparation practices are recommended for potato crop:

- In the first place appropriate sites should be selected for the cultivation of potato;
- It is important that the site should not be previously occupied by potato or related crop species such as cucumber, tomato, pepper, eggplant and tobacco during the preceding four consecutive seasons to avoid the build up of diseases, insect pests and nematodes;
- Prepare the land immediately after harvest of the preceding crop and before the soil is losing its moisture for ease of ploughing;
- Plough the land 2 to 3 times following the germination of weeds at a depth of 25 to 30cm;
- Frequent ploughing can help to loosen the soil to enhance rapid germination and further uniform crop development;
- Then maintain a furrow keeping a distance of 60- 75cm between rows and make ridges of

different sizes depending on the soil type and topography of the area;

- Apply pre-planting irrigation a day or two days before planting in order to maintain available soil moisture germination and to maintain the permanent shape of furrows.

Preparation of tubers for planting

In general, for obtaining high production of potato, it is important to pay special attention to use quality planting materials and its prior preparation for planting. The following areas need special consideration:

- Potatoes are usually propagated by planting seed tubers that are locally produced;
- Separate potato tubers in their size and store them to sprout;
- For rapid germination and uniform plant development only sprouted tubers should be used;
- For dry season planting tubers should be stored in a cool ventilated store for about 2 to 3 months to develop appropriate sizes of sprouts;
- Tubers stored for seed purpose should have three and more sprouts that are well developed and approximately 1cm long can be used as a criteria for planting;
- Do not use large or small size tubers for planting, instead medium sized tubers with about 40- 60 g weight, not affected by insect and disease as well as not peeled skin are more appropriate tubers for planting purpose;
- Care should be taken during transportation in order not to damage sprouted tubers.

Planting

- Under irrigation the crop is mainly grown on ridges. If the planting is for seed purpose, then potato can be planted on both sides of the ridge with the ultimate objective of obtaining high production of medium sized tubers, whereas if it is being cultivated for consumption the planting method is just in one side of the ridge with the ultimate objective of obtaining large sized tubers that have better market value, with less tuber in numbers, but with increased production;
- The crop is frost sensitive, therefore, it is recommended to plant in frost-free periods, usually under irrigation the more appropriate time for potato planting is starting from first week to end of January, but in low land or frost free areas it can be planted starting from September onwards;
- For planting 1 ha of land 15 to 20 quintals of sprouted tubers or 1, 500- 20, 000 kg/ha, depending on the size of tubers, are required;
- The sowing depth is generally, 8-10 cm, while plant spacing for production purpose is 0.75 X 0.3 m under irrigation, whereas for rainfed planting the distance can be increased to ensure sufficient soil moisture (80 – 100 cm). For seed purpose the planting distance should be

reduced and maintained as 20 cm between plants and 60 cm between rows;

- If the sprout is only one per tuber the sprouted part should be put upright and covered with the soil;
- Attention should be given to irrigate immediately the newly planted field.

Cultivation /Weed control

Inter- cultivation and timely weeding are important operations that should be undertaken in order to improve the soil aeration and water infiltration and reducing weed competition for water, nutrients, sun light radiation and space. These operations can be handled simultaneously of as independent activities. Potatoes are not strongly competitive with weeds. Prompt removal of weeds by pulling, hoeing or tillage is essential to avoid competition with the potato plant for nutrients and moisture. Delayed weed control is very serious because of the interference with tuber formation and development. Particularly, weed competition is most damaging to potato in the early growth stages, until canopy formation; therefore, thorough weed control at these early stages is essential from 7- 12 weeks depending upon the variety and growth conditions. Generally, minimum of two to three weeding are necessary, depending upon the competitiveness of the variety, the type and intensity of weeds and the growing conditions, till full canopy closure.

Therefore, the recommended weed control practices under potato are:

- (1) Potato field should be free of weeds, then cultivation and weeding is important;
- (2) 2- 3 times cultivation and earthing up is important till the canopy is well established;
- (3) Shallow cultivation and earthing up is also important to perform when the crop is at 15 to 30 cm height, particularly to avoid greening of tubers when exposed to sunshine and to maintain its food value and to kill weeds and to control potato tuber moth.

Fertilizer application

Potato is a high nutrient requiring crop and responds positively on fertilizer application. In this regard, poor soil management is perhaps one of the most important constraints for low productivity. Although improved cultivars are important components of production, they require proper soil management in order to realize their yield potential. Nutrition of potato is dominated by its shallow rooting habit and rapid growth rate. So that high yields necessitate a good supply of nutrients throughout the growth period. Application of organic and also inorganic fertilizers increased yield of potato significantly up to 50 % and above. As the same thing is true for other field crops, before fertilizer application it is important to consider soil properties and fertility status, chemical properties of the fertilizer and their nutrient uptake behaviour of the variety of potato planned to be cultivated.

Manure is one of the most important organic fertilizer sources applied under potato, even though its

effectiveness is different depending on different soil and climatic conditions of the area. Therefore, it is highly recommended to apply manure under potato considering the soil and climatic factors. In Ethiopian condition, it is recommended to apply manure at a rate of 20 t/ha if it is available. The recommended amount of manure has to be applied 2 to 3 months prior to planting and incorporate with the soil thoroughly in order to give time for decomposition and make available the nutrients required by the crop. Nitrogen results in early development of the foliage and, therefore, of photosynthetic capacity and maintains active photosynthesis for the required growth period. However, an excess supply may delay tuber initiation and therefore, reduce yield. Nitrogen requirement depends on many factors including soil types and previous cropping practices. In high rainfall areas or under irrigation conditions, a split application of nitrogen fertilizer is recommended, to reduce losses of nitrogen, due to leaching. However, application of nitrogen after tuber development will prolong vegetative growth and delay crop maturity.

Potato needs a good supply of readily available phosphorus, since the root system is not extensive and does not readily utilize less available forms. Because of low efficiency of uptake by potato, phosphorus fertilizer application needs to be considerably higher than the 30 - 80 kg/ha of P_2O_5 taken up by the crop. Phosphorus fertilizer recommendations are, therefore, high in most tropical situations, ranging from 100- 200 kg/ha of P_2O_5 for most tropical potato crops. Phosphorus fertilizer is used more efficiently by potatoes if side dressed and this is especially so at low or moderate application rates. Water- soluble Phosphorus fertilizer is the most efficient source for application under potato crop. Potassium also plays key role in photosynthesis and starch production in potato crop. High yielding varieties can remove 300 kg/ha or more of K_2O in the tuber alone. Potassium fertilizer requirement depends on soil supply and organic manure application. Irrigation can improve availability of soil potassium and there can be varietal differences in susceptibility to potassium deficiency. In Ethiopia, however, recommendations of potassium fertilizers are not available, of not only for potato but also for other crops.

Potato quality is also influenced by nutritional imbalance. Excess nitrogen fertilizers can reduce tuber dry matter and cooking quality, while deficiency of potassium can cause blackening of tubers. The following are recommended for potatoes for most potato growing areas of Ethiopia:

- Recommended to use 200 kg/ha of DAP before planting or during planting;
- 150 kg/ha of Urea should be added in split application;
- For Chiro variety in West Hararghe potato growing areas recommended to use 100 and 150 kg/ha of DAP and Urea respectively;
- Similarly, for West Amhara potato growing areas 100 and 150 kg/ha of DAP and Urea are recommended respectively;
- The first half urea is applied when the plant height is at 15 to 20 cm or after 30 to 40 days after planting just at the time of first cultivation and earthen up. The second will be given at the second cultivation and earthen up or at the starting of flowering and covered with soils;

- Irrigation water should be applied to the field immediately after fertilizer application;
- Application of organic manure or compost under potato is highly recommended if it is available to supplement the high nutrient requirements of the crop /200- 400 qt/ha well decomposed manure before land preparation/.

Water requirements

The total crop water requirement for 120-150 days of potato is about 500 to 700 mm, depending on the climate. Potato is relatively sensitive to soil water deficit. To optimize yields the total available soil water should not be depleted by more than 30- 50 %. Depletion of the total available soil water during the growing period of more than 50 per cent results in lower yields. Water deficit during the period of stolonization and tuber initiation and yield formation have the greatest adverse effect on yield, whereas ripening and the early vegetative periods are less sensitive.

Irrigation scheduling

Potato being a shallow rooted crop requires frequent irrigations of shallower depths rather than a few heavy irrigations. In this regard, on average 7 - 10 irrigations are applied during the growing period. The interval between irrigations depends mainly on soil types and the crop growth stages and a range of 7 to 10 days interval is used depending on soil type and temperature of the area. Therefore, irrigation intervals for sandy loam soils may be from 6 to 7 and 9 to 10 days for loam soils. However, the irrigation intervals might be longer in the early crop development stages and shorter with increased vegetative growth and stolonization and a little bite longer up to 15 days before harvesting.

The potato field should be kept moist but not wet throughout the duration of the crop-growing period. The field may be pre- irrigated before planting with aim of enhancing rapid germination and uniform crop development. Irrigation should be discontinued 2 to 3 weeks before harvesting in order to enforce uniform maturity and to develop stronger skin of tubers that increase the keeping quality of tubers.

When rainfall is low and irrigation water supply is restricted irrigation scheduling should be based on avoiding water deficits during the period of stolonization, tuber initiation and yield formation. In order to save water for these critical stages supply of water can be restricted during the early vegetative and ripening periods. If water supply is deficit during the critical periods of water demand of the crop, due to water scarcity, subsequent irrigation produces a set of small-sized tubers and as a result leading to a reduction in yield and the market value of tubers, due to price is low. Water supply and scheduling are important in terms of tuber quality. Water stress in the early part of the yield formation period increases the occurrence of spindle tubers. Water deficits during this period followed by irrigation may result in tuber cracking or tubers with black hearts.

Irrigation methods

The most commonly used method for potato in Ethiopia is furrow irrigation.

CROP PEST CONTROL

Disease control

Potato is susceptible to a wide range of diseases, of which potato late blight /*Phytophthora infestans*/ is the most important fungus disease because no varietal immunity has been found in Ethiopia so far. In lowland areas, early blight /*Alternaria solani*/ is frequently found and it is also a fungus disease that attacks the leaves. The fungus can survive in the soil on plant refuse. Bacterial wilt /*Pseudomonas solanacearum*/ is endemic and affects potato in warmer areas. The organism that causes the disease is a soil-borne bacterium that may survive in the soil on crop residues for many years. It has a wide host range including tomato, pepper, tobacco, eggplant and different weed species. Invasion of potato by bacterial wilt is acute and destructive. The disease is soil-borne and may be transmitted by infected planting material and restricted to use planting materials where bacterial wilt is reported such as the Shashamane area. In addition, potato is exposed to viral disease attack such as leaf roll.

The most important aspect of disease control is to fully exploit preventive measures. Then the following are the recommended practices for the control of major diseases on potato:

1. Use of disease free planting materials or tubers;
2. Use of disease resistant varieties;
3. Keep strictly a 4 year cycle of crop rotation with cereals, pulses and fodder crops;
4. Rough out infested plants and buried them;
5. For the control of viral disease it is important to control aphids /the carriers/ by spraying 1.5 lit parathin per ha in every week;
6. For the control of early and late blights use 3 kg/ha of mancozeb mixing with 600 lit of water and spray every week or ridomyl M.Z 63.5 % W.P at a rate of 2 kg/ha mixing with 400-600 litre of water spray every week from 2 to 3 times repetitively.

Actually availability and affordability of the chemicals mentioned above is the very crucial issue in the Ethiopian condition, particularly at subsistence farmers' level. Therefore, as an alternative, particularly in areas where there is irrigation potential it is recommended to cultivate potato in dry season under irrigation in order to minimize disease infestation and extent of damage.

Insect pest control

Aphids, potato tuber moth /PTM/ and red ants are the major insect pests that attack potato. Red ants attack the stem and tubers by boring. Aphids are tiny insects green, white or black in colour

and have shiny body that attached with to the plant parts. It attacks and damages the plant by sucking lower parts of the leaves or young growing tissues of the potato plant. In addition, aphids serve as carriers for the transmission of viral diseases. Aphids can also attack the newly sprouted eyes of potato. PTM is a common insect pest in the lowlands that attack severely the stem and potato tubers in the field and attacks tubers in the store.

The following are the recommended practices for the control of these insect pests: Keeping strictly the recommended crop rotation practices, earthen up tubers in order to avoid insect pest attack, cleaning of storage areas before storing the new harvest, use the leaves of Lantana camara and neem tree with the stored products is effective, particularly against the control of PTM/, care should be taken not to damage the skin of tubers during harvesting to avoid further pest attack, field sanitation is also important, it is also recommended to use chemical means of protection as well, such as endosulfan 2 lit/ha or malathion 1.5 lit/ha mixed with 600 lit of water.

Harvesting and storage

Potato from planting to full maturity will take about 90 to 120 days on average depending on the specific environmental conditions and the variety. When the potatoes leaves are just turning to yellowish in colour, it is then the typical sign of maturity. Potato can be harvested at any size but usually best to let them grow to full size (until the vines die off), bearing market considerations. The vines should be dead before harvest for 2 reasons: (1) So the skins will set (harden); (2) To prevent transfer of late blight spores from the vines to tubers which can cause them to rot; vines can be killed topping or with gramoxone. Handle carefully to avoid bruising.

During harvesting in order the skin of tubers to become stronger and to harvest easily it is recommended to cut down the shoot or vegetative parts above the ground and leave for about 10- 15 days before harvest, particularly in hot climates. After the skin of tubers has become stronger it is then possible to dig out tubers using appropriate tools. Then afterwards it will be important to separate the tubers for seed purpose and for marketing or consumption and should be kept safely in appropriate areas not exposed to insect pests attack. But tubers isolated for seed purpose should be kept in diffused light store. Prompt harvest will reduce the possible damage by soil infesting insects that attack tubers. The tubers should be stored temporarily in a shaded, dry, well- ventilated place for seven to ten days to allow time for the skin to become well suberized, and for any cuts or bruises from digging to heal. Thereafter, they may be stored most satisfactorily in a well- aerated, cool, dry place until sold or converted into food. Potato gives yield between 200 and 350 quintals per hectare with adapted varieties under good management

4.2 SWEET POTATO /*Ipomoea batatas* - L./

IMPORTANCE OF THE CROP AND ITS USE

The center of origin for sweet potato is tropical Central America. The sweet potato is one of the World's most important food crops. The sweet potato is one of the tuber crops being cultivated in Ethiopia. Sweet potato was cultivated for so long as a garden crop. In Ethiopia sweet potatoes are widely growing in the southern, southwestern and eastern parts of the country.

The tuberous root is mainly used for human consumption and it has a great value as an energy food or a main source of carbohydrate, contains some protein and vitamin C. In addition, the young leaves are rich in protein and most vitamins. Furthermore, the stem and leaves of sweet potato are excellent source for animal feed. Sweet potato tuberous roots are used for food in a variety of ways. The leaves are also frequently used as leafy vegetables; even though it is not common in Ethiopia. Sweet potato is well known as a source of carbohydrate /25 to 30 %/. In addition, it contains limited amount of vitamins and protein /1.6 to 2.0 %/, fat 0.7 % and 1.0 % ash. The rest 60 to 70 % is water. Sweet potato is a crop of considerable unrealized potential, particularly in developing countries where most production is concentrated. Its popularity is, due to its ease of propagation, high productivity in 3 to 6 months time, excellent suitability in mixed cropping systems and low labour and input requirements.

VARIETIES

Most varieties that are widely grown by the farmers mature in around 5 to 6 months. The recommended varieties of sweet potatoes are indicated in Table 34. The average productivity level on research station is 200 to 350 quintals per hectare. Varieties with white tubers in the inside part seems to be preferred by local consumes but varieties with yellowish colour are higher in food value since they contain carotene.

Table 34. Major recommended varieties of sweet potato and their characteristics

Varieties	LPG (days)	Prod ^y (qt/ha)	Colour		Recommended areas for cultivation
			Skin	Inner part	
Koka- 6	120- 150	270	White	Creamy	Low- mid & low altitude areas
Koka- 12	120- 150	270	White	Yellow	"
Kudadie /TIS- 1499	90- 120	240	Purple	Creamy	"
Falaha /TIS- 3017(2)	90- 120	167	Purple	White	"
Dubo /I- 444	90- 120	217	Cream	White	"
Guntutie /AJAC- I	120- 150	354	Deep creamy	Deep creamy	"
Bareda- (375)	120- 150	296	White	White	"
Damota /Garalollow/	120- 150	306	Deep creamy	Creamy	"
Awassa- 83	150- 180	366	Reddish	White	"
Belela /192040- II	150- 180	250	Creamy	Creamy	"

Source: Awassa Agricultural Research Centre

SOIL AND CLIMATIC REQUIREMENTS

Soils

Sweet potato has an ability to perform well on poor tropical soils as compared with some other root crops, so that subsistence farmers can produce it easily without fertilizer. The best soils for sweet potato cultivation are light, well-drained and aerated sandy loam or loamy sands, with pH value of 4.5 to 6. Heavy clays and waterlogged soils are not recommended for sweet potato production.

Altitude

Sweet potato is grown over a wide range of climatic conditions, just from sea level to 2300 m above sea level that means cultivated in the tropics, subtropical and temperate zones and increasingly being produced as a cash crop, as well as a subsistence crop grown in home gardens. The best suitable altitude ranges are from 1500 to 1800 m above sea level. Sweet potato is a lowland crop and it does not withstand frost damage. Sweet potato when growing above 2, 100 m the size and the test will be reduced and the maturity period will be elongated.

Temperature

Sweet potatoes require fairly high average temperatures of 20 to 30 °C optimum temperature is about 25 °C with plenty of sunshine and a good distribution of rainfall during the growing season. However, areas with an average temperature of 22 °C are best suitable for its production.

Rainfall

Under rainfed condition it thrives best where the average annual rainfall is between 700– 900 mm, below this, the crop requires irrigation. Even though, sweet potato is considered as drought resistant crop, research results confirmed that the crop need sufficient amount of rain or supported by irrigation water, particularly in the early 6 weeks of growth, if not supplied with sufficient amount of water during this period of growth, the yield dramatically declines.

Production constraints

The productivity of sweet potato at farmers' level is low, whereas in research stations it is possible to harvest more than 350 quintals per hectare. The following are the main production constraints: (1) Inadequate supply and cultivation of improved varieties among the farmers; (2) Low adoption rate of improved agronomic practices; (3) Insect pest damage, particularly sweet potato weevils and PTM are the main causes for low productivity of sweet potatoes.

The following are the recommended improved practices and technologies for the increment of production and productivity of sweet potato.

RECOMMENDED IRRIGATION AGRONOMIC PRACTICES

Land preparation

- Land preparation is carried out depending on the specific conditions of the area
- Based on the soil type and weeds the field need to be ploughed deep, loosen and leveled;
- After the field is leveled it is important to make furrows or ridges 100 cm apart;
- Add manures two months prior to planting and incorporate it with the soil immediately;
- Pre- irrigate the field a day before planting to maintain available soil moisture to enhance rapid and uniform germination.

Propagation of sweet potato by cuttings

Sweet potatoes are propagated frequently using vine cuttings or from tubers. Propagation from cuttings is possible only when the sweet potatoes remain in the field all round the year. The cuttings should be 20 to 40 cm long, with 3- 5 growth buds. It is best to take them from the tips of young stems, since plants from terminal cuttings produce high yields than those propagated from basal or mid stem cuttings. Take the cuttings only when you are ready to plant them, and keep them in the shade until they are inserted in the soil. Propagation from cuttings is the most economic way of increasing sweet potatoes production.

Preparation of cuttings

Sweet potato cuttings could be prepared from the top and middle of the vine 20 to 40 cm in height and having 2 to 3 internodes avoiding the leaves. However, the upper part of the vine is best suited as a planting material. First it is important to select healthy vines and prepare cuttings by avoiding the leaves. Next, it is vital to prepare a vine of 20 to 40 cm height for planting. For 1 ha of land approximately 56, 000 cuttings are required including contingency.

Planting

- Planting of sweet potato cuttings should be done no later than 5 months before the end of the rainy season, but under irrigation it can be planted at any time of frost free period;
- The vine cuttings can be planted on heaps, or on ridges;
- The cuttings should be 30 cm in length and placed 10 cm deep in the soil and covered half with soil (inclined at 45°) and keeping the space 20 to 30 cm between plants, whereas between rows 60 to 100 cm (60 cm between rows x 30 cm between plants);
- Irrigate the field immediately after planting.

If there is no a possibility to find out growing plants of sweet potatoes in the field with enough leafy growth to provide cuttings, it is also possible to use tubers for propagation. In this case, the tubers must be made to sprout in a cool nursery bed. If the tubers are large, cut them into several pieces. After about a month, remove from the tubers the young shoots that are 15 to 20 centimetres long and plant them. However, this is not the best alternative, unless and otherwise, there is a difficulty to find cuttings.

Weeding /cultivation

Sweet potato is very sensitive to weed competition, particularly during the early growth stages. Research results confirmed that weed competition could reduce the yield up to 90 % unless controlled timely, at least two times. Bearing this fact in mind, it is important to make weed free field of sweet potato. Right at the start of tuber initiation it is important to cultivate and earthen up the tubers. The first weeding can be performed 40 to 45 days after planting and the second at 70 to 75 days and earthen up the tubers can increase the tubers yield as it was confirmed by research results. When the crop grows further and develops leafy growth will closely cover the soil and the weed competition will be less.

Fertilizer application

On most soils, tuber yield is increased by the application of nitrogen fertilizer. However, an excess of nitrogen can stimulate increased foliage production at the expense of tubers and may also lead to tuber cracking. Full benefit from nitrogen application is only obtained when sufficient potassium is given or present in the soil. A sweet potato crop removes more potassium than phosphorus from the soil and potassium fertilizer has greater effect on the yield than phosphorus fertilizer. In this case, sweet potato requires a relatively large amount of potassium and has an average requirement of nitrogen and phosphorus.

Fertilizer may not be required, if the crop is grown in rotation with legumes and cereals, which have been received fertilizers. However, the recommended rate of DAP is 175 kg/ha and it should be applied at the time of land preparation or planting, whereas Urea 80- 100 kg/ha and should be applied 1 month later after planting and apply in both sides of the plant and incorporate with the soil immediately. However, in different parts of the southern part of the country and in the middle Awash the yield increment using fertilizers is not significant as per the information obtained from the research centres of the respective areas /Awssa and Melkasa Agricultural Research Centres/. Therefore, in those particular areas it is advisable to cultivate sweet potato without fertilizer application. If there are local recommendations available by nearby research centres it is possible to use the local recommendations. In addition, due to low crop price it is advisable to grow the crop by applying organic fertilizers such as manure and compost. Using organic fertilizers can reduce the overall production cost and it is in accordance with the interest of the farmer as compared with the application of mineral fertilizers. In addition to that the organic fertilizers can improve the soil structure and consequently improve the water-holding capacity of the soil.

Water requirements

For high yields, the total crop water requirement is about 500 to 700mm, depending on the climate. Sweet potato is relatively considered drought resistant. However, starting from germination for about one month time the crop needs more water and then frequent but light irrigation is essential, particularly after thinning operation. Water deficit during the early vegetative growth periods and tuber initiation and yield formation have the greatest adverse effect on yield, whereas ripening is less sensitive. But excess watering when the tubers are actively developing leads to increase the tubers length in the expense of decreasing the tuber size, sugar content and the overall yield. Therefore, controlled watering during this stage of growth is essential. As a result of water deficit and inadequate supply of nitrogen of the soil, the root development of the crop reduces, while the sugar content is increasing.

The irrigation water should be discontinued 2 to 4 weeks of time before harvesting. However, it is also important to remember that the soil should not be completely dry otherwise it will be difficult to dig out the tubers. The crop is relatively salt tolerant, except during germination and early growth stage. However, it is important to take appropriate control measures whenever the salinity problem is increasing.

Irrigation scheduling

Sweet potato being a shallow rooted crop requires frequent irrigations of shallower depths rather than a few heavy irrigations. In this regard, on average 7 - 10 irrigations are applied during the growing period. The interval between irrigations depends mainly on soil types and the crop growth

stages. Therefore, irrigation intervals for sandy loam soils may be from 6 to 7 and 9 to 10 days for loam soils. However, the irrigation intervals might be shorter in the early crop development stages and a little bit longer with increased vegetative growth and tuber formation and up to 15 days before harvesting. The sweet potato field should be kept moist but not wet throughout the duration of the crop. The field may be pre-irrigated before planting with the aim of enhancing rapid germination and uniform crop development. Irrigation should be discontinued 2 to 4 weeks before harvesting in order to enforce uniform maturity and to develop stronger skin of tubers that increase the keeping quality of tubers.

When rainfall is low and irrigation water supply is restricted irrigation scheduling should be based on avoiding water deficits during the period of early development, tuber initiation and yield formation. In order to save water for these critical stages supply of water can be restricted during the ripening period. If there is a water supply deficit during the critical periods of water demand of the crop, due to water scarcity, subsequent irrigation produces a set of small-sized tubers and as a result leading to a reduction in yield and the market value of tubers. Therefore, water supply and scheduling are important in terms of tuber quality. Water stress in the early part of the yield formation period increases the occurrence of spindle tubers. Water deficits during this period followed by irrigation may result in tuber cracking.

Irrigation methods

The most commonly used irrigation method for sweet potato in Ethiopia is furrow irrigation.

CROP PEST CONTROL

Disease control

Even though, disease prevalence on sweet potato is not critical in Ethiopia, black rot and soft rot are the major ones that attack the crop seriously. Diseases attack the leaves, stems and tubers. Damaged tubers at harvest are most quickly attacked by rot. Damp conditions encourage rotting. The recommended measures for control aforementioned diseases are use of disease free planting materials, use of disease resistant varieties, keep strictly a 4-year crop rotation cycle with cereals, pulses and fodder crops; rough out infested plants and buried them, during harvest care should be taken not to damage the tubers in order not to expose them to soft rot attack.

Insect pest control

The major insect-pests that attack sweet potato are weevils and sweet potato caterpillars. Of these, the weevil (*Cylas puncticollis*) is the most serious insect pest that can cause significant damage of sweet potato in the tropics, which attacks all parts of the plant. The adult insects attack the leaves, stems and tubers. The female insects lay their eggs in the stems or roots; then the larvae tunnel into tubers. Therefore, for effective control of the weevil the following are recommended to apply: (1) Keep strictly the recommended a four year cycle crop rotation practice; (2) Use pest free vines or cuttings for planting that were not attacked by weevils; (3) Earthen up tubers in order to avoid insect pest attack; (4) Rouging out plants that are attacked by weevils; (5) Increase plant population per hectare in order to minimize the tubers size and as a result the damage incidence by weevils will be reduced; (6) Take care not to damage the skin of tubers during harvesting to avoid further pest attack; (7) Use immediately the tubers for consumption or for marketing; (8) Store tubers for

2 to 3 weeks in underground pit to kill the weevils and reduce the damage level; (9) When all the above alternatives are not effective it is also recommended to use chemical means of protection.

Harvesting

Sweet potato matures in about 4 to 5 months time. The typical characteristics of maturity symptoms for good keeping are when the leaves and stems have turned yellow indicates the ripening of sweet potato tubers. In addition to that tubers are becoming strong. Depending on the variety sweet potato matures on average within 165 days. The best way to make sure the maturity of the crop is to dig up a few tubers and see if they're reached the required size; small tubers have more flavors, but large tubers mean larger yields. Yellowing of the lower leaves is usually a sign of approaching maturity. Then cut vines and dig up roots with appropriate implements. During harvesting and at the time of cleaning great care should be taken in order not to damage the skin of tubers. Remove all diseased and damaged tubers. After harvest it is also important to dry the tubers in the sun for sometime before cleaning the soil from the tubers, then it is possible to clean the soil and wash the tubers with water carefully. Sweet potato can yield 100 to 150 qt/ha or more depending on the potential of the variety and growing conditions.

Storage

Before storage, tubers should be rubbed thoroughly in wood ash. A dark, dry, cool, well- aired place is ideal for storage up to 1 year without great losses. The tubers may also be stored in a pit in the ground, covered with a layer of 10 to 15cm of soil and a plastic sheet on the top.

5. IRRIGATION PRACTICES IN SOME FRUIT CROPS

5.1 Banana /*Musa spp.*/

IMPORTANCE OF BANANA AND ITS USE

Banana is one of the most important fruit worldwide and is probably the best-known tropical fruits among the short-term perennials. Ripe banana is sugary and eaten raw. Unripe fruits called plantains are cooked and provide a starchy food with nutritional value equivalent to that of potato. The cultivated banana is believed to have originated in the lowland and humid tropics of South East Asia (present day of Malaysia, Indonesia, Philippines and Berma). Then it was introduced to Africa in the 15th century and at present Africa is considered as the main producer of banana and plantains mainly for local consumption and followed by India, Malaysia, Taiwan, and the Philippines. However, Honduras, Costa Rica and Panama are the leading producers of banana for export.

Banana is one of the recently introduced fruit crops to Ethiopia. Since its introduction, in most villages of Ethiopia, like in other African countries, banana is often growing in refuse disposal areas where they benefit from decaying organic matter and receiving less attention for its management. This indicates that sufficient attention is not given to the crop and as a result, the farmers are not getting the required economic benefit from growing banana beyond that of home consumption. However, recently the supply of banana to the local market has increased; particularly the large share is coming from the southern part of the country.

The banana fruit is a valuable source of energy-giving food rich in carbohydrate as compared to other fruit crops. The sweet banana, eaten raw when it is ripe, is as rich as other raw fruits in carbohydrates. In addition, banana contains a lot of vitamins; particularly vitamin C. Banana fruits should be eaten very ripe. The edible portion of banana fruit is contained about 75 % water, 1-2 % protein, 0.2 % fat, 23 % carbohydrate and 0.8 % ash. It is also relatively well supplied with calcium, phosphorus and iron, and with the principal vitamins. It is essentially an energy food, and should be supplemented with other foodstuffs that provide protein and fats to provide a balanced human diet. The carbohydrates present in ripe sweet bananas are highly digestible, and are well tolerated by people suffering from various intestinal disorders.

In the tropics including Ethiopia a banana plant serves many purposes. The trunk is often chopped up and fed to pigs, or in a tree nursery the trunk sheaths are doubled over and used as planting containers. The xylem strands are twisted together and used as ropes. A banana leaf can be cut up and made into small pots for transplanting garden seedlings, serve as a wrapping inside of which food is cooked, particularly in Ethiopia, it is being used traditionally for baking local breads, in the absence of leaves of false banana or locally called “enset”, which is usually preferred and used for this purpose, just by covering the bread on both sides during baking process, in order to protect the bread from overcasting. The green fruit can be fermented into vinegar and the ripe fruit into rum. The starchy pulp of the green fruit can be dried and made into flour or the ripe fruit can be mashed into a baby-food puree, or cut into chips and dried as figs, even though some of these food recipes from banana are not common in Ethiopia. There are different ways that bananas and plantains are mashed, cooked, chipped and fried. The male bud of hybrid varieties is used as cabbage. In general, man is making good use of bananas, since the time it has been brought to cultivation.

Description of the banana plant

The term “banana” encompasses a wide range of seedless varieties plus many wild seeded species. However, the discussion here is mainly focused on the production and management of seedless varieties of banana. The seedless varieties are generally propagated vegetatively using suckers, while the seeded varieties are propagated both vegetatively and by seed. All seedless varieties, except the plantains, which are not common in Ethiopia, when ripe, can be eaten as fresh fruit, and when green they can be cooked and utilized. The main distinction between a dessert banana and a cooking banana is the type and amount of starch granules contained in a given particular variety. The banana plant is not a tree. It is a giant herbaceous plant with an apparent trunk or stem of 2 to 9 m in height, which is called a pseudostem that bends without breaking and it has the role to anchor the plant upright. The banana has an underground stem called rhizome with adventitious roots with a width of 4- 5 m and can penetrate up to 0.75 m deep into the soil. It is full of food for the plant. Alongside the main stem, it has other stems called suckers. The suckers grow further into banana plants. The banana plant produces its fruit and dies and replaced by another suckers. Ideally, a clump of bananas should have only three shoots. The first one is the one that is fruiting, the second one is the one that is flowering and the third is the one that is not yet flowered. After the fruit has been harvested, the shoot which bore the fruit should be removed and another sucker allowed developing. With this cycle a continuous cycle of fruit production will be maintained and bunch size will be large.

The banana plant has large leaves with a length of 1.5 to 4 m and 0.7 to 1.0 m width that are closely rolled up one over the other. Together they look like a trunk, but they form only an apparent trunk. Inside it there is a bud, which produces leaves. The time from planting to shooting takes about 7 to 9 months and then the bud produces flowers. The flowers of banana form a large spike. The spike comes out of the apparent trunk and turns to the ground and opens. It bears male and female flowers. The female flowers pressed closely together in the shape of hands. The bunch is formed; the hands are turning up and a red bud at the end of the spike containing the male flowers; then the male flowers die quickly and the bud slowly becomes smaller. Then the banana plant further yields fruits. The banana fruit forms on the upper nodes of the true stem, which pushes up the length of the trunk until it emerges at the top and at this stage it is said that the plant has “shot” its fruit. The individual banana fruit is called a “finger”, and the two rows of fingers, located at each node on the stem, are called a “hand”. The whole stem, with its many hands in one spike, is referred to as a “bunch”. The spike produces many bananas. On this bunch, the bananas are clustered in several hands. The flesh of a banana is light in color, sweet and soft. The edible banana varieties do not produce seeds. The dark, small specks in the central portion of the banana fruit are the aborted ovaries, which, even when pollinated, fail to develop into seeds. The fruits are long in shape, with yellow or green skin.

A “button” is located in the middle of each rhizome node, and is covered by the leaf sheath. When the leaf dies, and the leaf sheath rots away, the “button” grows out of the side of the rhizome, pushes through the soil, and emerges as a sucker. Each sucker can develop into a plant, which will fruit only once, and dies.

A “button” is located in the middle of each rhizome node, and is covered by the leaf sheath. When the leaf dies, and the leaf sheath rots away, the “button” grows out of the side of the rhizome, pushes through the soil, and emerges as a sucker. Each sucker can develop into a plant, which will fruit only once, and dies.

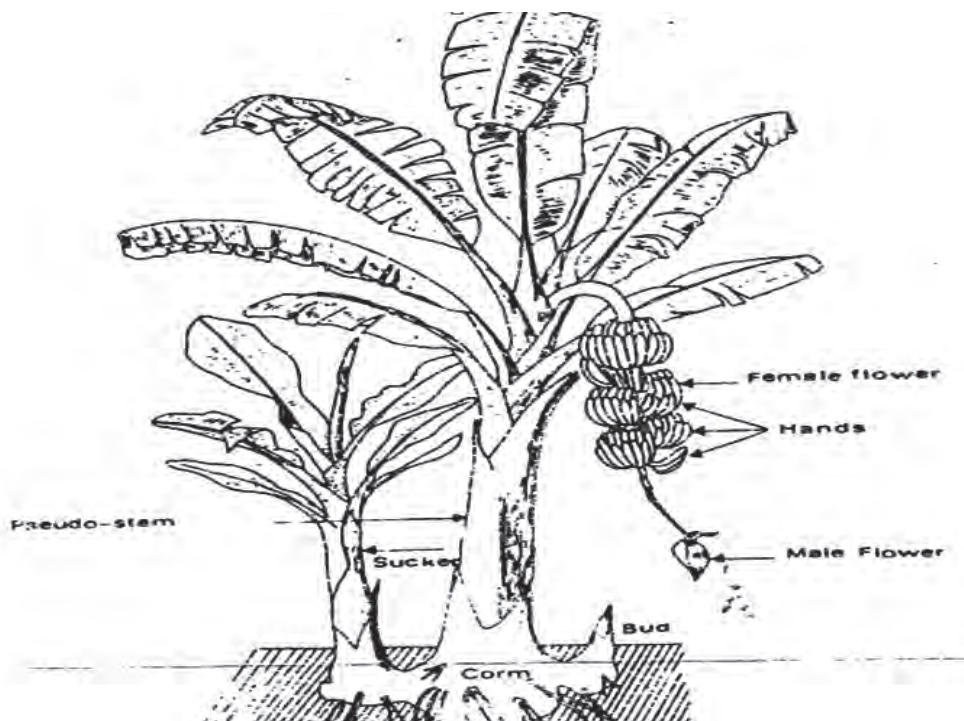

Fig. 37. A diagram showing the banana plant and its parts /adopted from FAO Yield Response to Water, 1986

VARIETIES

Banana is not indigenous to Ethiopia as described earlier. Different varieties were introduced by different actors being involved in horticultural related activities. At present existing different varieties of banana with different shape, size and taste of fruits. The varieties recommended for cultivation in Ethiopia are:

- Dwarf Cavendish- it is a variety extensively planted in recent years in Ethiopia both on farmers fields and state farms, but its popularity is being declining; due to susceptibility to borrowing nematodes and cigar end rot disease;
- Poyo is the leading variety as compared with dwarf Cavendish varieties and the fruit is reported to be comparatively resistant to transport damage and
- Giant Cavendish, which is a tall- growing strain of Cavendish, is one of the varieties recommended both for commercial plantations and under farmers' conditions.

SOIL AND CLIMATIC REQUIREMENTS

Soil

Banana can be grown on a wide range of soils provided they are fertile and well-drained. Stagnant water will cause diseases such as the panama disease. The best soils for banana production are deep, well-drained loams with a high water holding capacity and humus content. Optimum pH is between 5 and 7. There is no use to attempt to grow bananas on a profitable commercial basis in soils, which lack fertility or poor in their physical structure. The root system of the banana

plant forms a semispherical zone centering on the rhizome (the underground stem). The radius of this semi-sphere and its depth depends on the variety, the type of soil, and the drainage system in the field. If the water level remains 60 cm below the surface, the roots will not extend further downward, even though the soil may be sandy-loam. Therefore, fairly deep soil and deep water table is essential for better growth and normal yield. Poorly drained, highly acidic and saline soils must be avoided for banana production.

Altitude

Banana is best grown in warm climate areas. In Ethiopia, banana is being grown from low to medium altitude ranges both under rainfed and irrigation conditions in homestead and in large state owned farms. However, areas with altitudes below 1,000 m a.s.l having irrigation facilities are best suited for good harvest and high quality of produce. Overall, areas with altitudes below 1500 m a.s.l can be considered suitable for banana growing. Even in some particular areas it can be grown in higher altitudes up to 1800 m a.s.l, particularly the subtropical Dwarf Cavendish variety. As a general rule, since elevation in tropical regions greatly affects temperatures, and bananas being sensitive to chill, it should not be grown over elevations of 1,000 meters above sea level. Therefore, it is wise to use only the dessert bananas of the short stature varieties at the higher elevations. All sizes of dessert bananas can grow easily between the equator and 15°N and S, but between 15 to 23°N and S, it is better to choose varieties with intermediate stature, such as Giant Cavendish and the like. Beyond 23°N and S, it is best to cultivate Dwarf Cavendish varieties.

Temperature

Banana is growing best in a warm climate region. Mild freezes may kill the top growth back to the ground in some regions, but the rhizome if not damaged will send additional shoots up again. This occurs sometimes in the highlands of the tropics and subtropics. Under such conditions, to produce fruit within the frost-free periods, the planting rhizomes must receive special treatment. All of the eyes are removed except one so that most of the growth from the entire underground parts goes to this one shoot which develops a larger stalk and ripens earlier than it otherwise would. However, under such conditions, it is not recommended to cultivate banana. The average optimum daily temperature best suited for the growth of bananas is about 27°C, the average minimum, 21°C, and the average maximum, 29.5°C, The absolute minimum and maximum temperatures are 15.6°C and 37.8 C, respectively. Exposure to temperatures below and above these absolute temperatures slows down growth and damages the fruit.

Rainfall

The optimum amount of moisture required for uniform growth is about 1320 mm of rain per year, or still better, a uniform distribution of 2.5 cm per week. In some regions, most of the precipitation will occur between the months of May to November. Usually, the months from December to April are receiving the minimum requirements of precipitation. For uniform growth and to obtain a good yield, banana plantations should be irrigated during the dry months. If, however, irrigation requirements approach five months out of the year, the cost of maintaining uniform growth becomes excessive, and this indicates the need of establishing banana plantations in areas where promising irrigation water is available.

Wind

Banana leaves are large, soft, and easily torn by strong winds, which seriously reduce its productivity. If natural wind-protected areas do not exist, it is highly important and recommended to provide

windbreaks for the plantings. The large growing bamboos make excellent windbreaks, while *Leucaena glauca* can be effectively used around homestead areas. The ideal location is a protected valley as can be noted by observing growth of local vegetation and the amount of leaf damage in the area. This is why subsistence farmers in Ethiopia are growing banana in valleys where natural wind-protection exists. The majority of banana varieties can tolerate winds of up to 40 kilometers per hour. Winds between 40 to 55 kilometers per hour cause a moderate amount of damage, but winds above 55 kilometers per hour are disastrous and cause “blow-downs”, in which a large portion of a plantation can be broken.

RECOMMENDED IRRIGATION AGRONOMIC PRACTICES

Land preparation

Soil should be deeply ploughed in both directions and harrowed to a fine enough tilth to enable irrigation furrows to be laid out effectively along each plant row. The land for banana plantation should be well prepared and leveled. After leveling the field, it is important to make a furrow of 30 m length and with 2 m apart one from another. Depending on the soil type of the field the furrow length could be shortened or lengthened. As a general rule, in sand soils short furrows are recommended, while in heavy soils the furrow length could be longer. As part of land preparation one or two months prior to planting, it is important to make a planting hole at the places where the pieces of planting materials of banana would be planted later. Make the planting holes 60 cm deep, 60 cm wide and 60 cm long. It is important that the soil from the top should be put on one side and the soil from the bottom on the other side. Then fill the holes with compost and manure to enrich the soil within the planting hole with nutrients that could be used further by the new planted banana suckers.

Preparation of suckers for transplanting

Usually, banana is propagated vegetatively, using suckers and piece of corm with one to three eyes. Both types being dug out from around mature plants. In Ethiopia, suckers are normally used. It is important to select the right type of suckers as this will affect subsequent growth and yield. Suckers of different ages are used as planting materials. The following points should be considered during sucker preparation: (1) Use suckers taken from banana plants that are between 3 and 6 years old; (2) After a seed-piece is dug up, all soil, roots and trash should be completely removed; (3) Suckers should be between 50 cm and 1 m high and broad at the base and let them dry in the shade for 3 or 4 days before planting; (4) If nematode lesions are detected on the roots, these should be pared off along with any dark and reddish tissue, until the seed piece is clean and white leaving a few buds; (5) Just before planting them, trim them at a point 50 cm from the base of the plant and dip them in boiling water at 52 °C for about 20 minutes in which potassium permanganate is mixed or dipping the planting material in a nematocide may reduce damage from nematodes and boring insects; (6) It is important to select uniform size of suckers; (7) Rhizomes, or “sword suckers” 50 to 60 cm tall and enlarged at the base, which bear only long slim narrow leaves are most productive suckers and more preferred for propagation; (8) “Water suckers” with a size of 1 to 1.5 m long with broad leaves can be used for planting without topping but these are not preferred as such, due to smaller corms; (9) “Maiden head sucker”, which is from 1 to 1.25 m tall and from a plant, which has not yet flowered can be used as planting material, if there is a shortage of planting material ; (10) If seedlings of improved varieties of banana are not available, it is recommended to choose and prepare planting materials from the local cultivars and (11) After five years on average the banana becomes old and reduced its productivity, and therefore, recommended to replace the plantation with new ones.

Planting and planting methods

Holes of 50 cm deep and 50 cm wide in diameter are prepared at least two months ago before planting. The top soil should be put separately and mixed with about two buckets of well rotted manure if available. The planting distance between hills depends primarily on the size or the height of the variety being cultivated, the type of soil, the amount of fertilizers applied, and the pruning practices existing in the area. The variety Dwarf Cavendish can be planted in rows at a distance of 1 m between plants and 2 m between rows, while the variety Giant Cavendish can be planted in 2.5 x 2.5 square meters. The deeper the soil, the closer can be the planting distance for a variety, as long as excessive shading does not occur. However, for irrigation convenience a spacing of 2.5 m between rows and 2 m between plants with a total plant population of 2,000 plants/ha is sometimes recommended.

At planting time, put the soil from the top into the bottom of the hole and place the sucker in the earth. The base of the sucker is now 10 centimetres from the surface of the ground. Put compost round the young plant. Put the bottom soil on the ground surface. Place about 40-50 grams of N and 20-25 grams of P fertilizer per hole 10 cm deep before planting mixing with 5 kg of manure, plus 25 grams of a granular nematocide in the bottom of the hole and return back to the hole a 10 cm thick layer of soil. If it is not possible to add a granular nematocide, it is good to dip suckers in a solution of copper sulphate, or temik or some other chemicals used for this purpose. The soil around the seed piece should be well compressed and irrigated soon after. The best time for planting rainfed bananas is at the beginning of the rains, although with a continuous supply of irrigation water any time of the year would be satisfactory for transplanting seed pieces to their permanent place.

Weed control

Weed control is necessary at early stages of growth before a plantation is established, whereas an old plantation usually shades out the weed. Weed control is also required on the borders of plantations, around the irrigation canals and drainage ditches, and pathways between plantations. Application of recommended herbicides is the most efficient method of controlling weeds by taking care not to damage the leaves of banana. If the land is well prepared, maintained appropriate spacing, and mulched, weed control should require less effort. Cultivation should always be shallow in order to avoid or minimize damage to the roots. In order to minimize weed competition it is also recommended to inter crop some leguminous crops between the banana rows.

Fertilizer application

Banana is a heavy feeder and yields can be increased dramatically by applying fertilizers. Bananas need fertile conditions and abundance of soil moisture for best growth and optimum production. The type of development the plant makes in the first 3 to 4 months determine the weight of the bunch and number of hands the plant can bear. The N-P-K formulation to be used depends on the type of soil. The main nutrient requirement is nitrogen, which is generally applied in the form of urea. N stimulates faster growth, greater leaf area development, and increased fruit size. P needs is relatively low as compared with that of N and K.

For a year old banana plant, it is recommended to apply 50 g of N at the time of planting and 50 g of N after 4 months of planting/in both application use 100 kg/ha rate/. Nitrogen should be applied in small amounts at frequent intervals throughout the year. The appropriate recommendation for phosphorus fertilizer is 50 kg/ha of P_2O_5 or about 50-100 grams P_2O_5 per plant after 8 months of planting. Apply the recommended fertilizer 10 to 15 cm far away of the stem of the plant.

The recommended P can be applied in one application in the planting hole and thereafter once or twice yearly as surface dressings. P deficiency causes a premature drying of the lower leaves. Potassium greatly increases yields and pseudostem growth, improves fruit quality and storage life, and promotes disease resistance. Deficiencies of potassium indicate yellowing around the outer edges of the leaves; more severe hunger causes the leaf tips to turn reddish-brown and die. K hunger is also associated with the disorder called “premature yellowing” of the leaves. For well-developed banana plant apply 100 kg/ha rate of N every four months and 50 kg/ha of P_2O_5 once in a year. Apply 8- 10 kg per plant of well-decomposed manure, whenever available. The application method is as indicated earlier.

The amount of fertilizer used depends on the number of mats per hectare; about 600 kilograms of nitrogen per hectare per year is an appropriate estimate for a deep alluvial soil. If there are 1,000 mats per hectare, then each mat receives 600 grams of nitrogen per year. Fertilizer should be applied in a circular band around the mat. After planting a seed-piece and up to three months after emergence, the band should have a radius of 50 cm. The radius should be enlarged as the plant matures. The radius of the fertilizer placement around mature mats should be between 1- 1.5 m. On the average, a plantation should be fertilized about every sixth week. During the rainy season, this interval could be reduced to five or even four weeks, and during the dry season under rainfed cultivation it might be increased to seven or eight weeks. The addition of manure in the planting holes and as a side dressing is beneficial nutritionally and also contributes to improving the water-holding capacity of the soil. The practice of chopping banana residues into small pieces and spreading them in a thin layer around the plants is also beneficial, since this organic material is high in potassium as well as acting as mulch, which conserves soil moisture. Application of 3- 5 kg/plant of farmyard manure is recommended to be applied under banana and worked out with the soil.

Water requirements

Being a long duration crop, the total water requirements of banana are high. Water requirements per year vary between 1, 200 mm in the humid tropics to 2, 200 mm in the dry tropics. For rainfed production average rainfall of 2, 000 to 2, 500 mm per year, well distributed is desirable, but banana grows under less rainfall condition. As it is indicated above, banana requires an ample and frequent supply of water. Water deficits adversely affect crop growth and yield of banana.

The establishment and the early phase of the vegetative periods determine the potential for growth and fruiting and adequate water and sufficient supply of nutrients is essential during this period. Water deficits in the vegetative period affect the rate of leaf development, which in turn can influence the number of flowers and consequently it can influence the number of hands and bunch production. Water deficit during the flowering period can also limit the leaf growth and number of fruits. Water deficit during the yield formation period affect both the fruit size and quality and consequently premature ripening of fruits can happen. The banana plant has a sparse shallow root system. Most feeding roots are spread laterally near the surface. Rooting depth not exceeding generally 0.75 m. in general, most of the water is extracted from the first 0.5- 0.8 m soil depth, of which 60 % is from 0.3 m.

Irrigation scheduling

A depletion of total available soil water is not more than 35 % during the total growing period is harmful to growth and fruit production. Therefore, frequent irrigation is important. The irrigation interval will depend on the total crop water requirement $/ET_m/$ and the soil water-holding capacity in the rooting depth and may vary from 3 days under high evaporative conditions and light soils

up to 15 days under low evaporative conditions and high water retaining soils. Under limited irrigation water supply it is advantageous to reduce the depth of each water application rather than to extend the irrigation interval.

Irrigation methods

In Ethiopian condition, the appropriate irrigation methods for banana production are furrow and basin irrigation methods. However, sprinkler irrigation systems with small application at frequent intervals are commonly being used in commercial plantations and drip irrigation, particularly in areas with scarcity of water are also practicable.

Pruning

Banana is a perennial plant, but each sucker or pseudostem, which arises from the mother plant, bears only one bunch of fruits. The removal of suckers is an important operation, which is often neglected. Pruning is the process of cutting suckers, or followers, at ground level, where they emerge from the mother plant. The main reasons for pruning are: (1) to arrange for the uniform harvest of a plantation throughout the year; (2) to prevent “walking” of the mats (spreading of the mat wider and wider) and the formation of holes and crowded areas in the field; (3) to avoid nutrient competition between the mother plants, setting fruit and young suckers coming out from the mother plant.

A field planted with bananas, yields all at the same time (the plantilla crop from new transplants). This fruit must be sold or discarded, according to market fluctuations. If one follower (sucker) were allowed to grow on each plantilla mat, then about three months later there would again be another crop ready for the first ratoon, or sucker harvest. This would result in flooding the market at one time and not having a crop ready for shipment when market demands are high. To avoid such a problem, a pruning method was developed that is based on uniform productivity per area per year. After the plantilla crop, the suckers, which have appeared on the mother plant, are pruned from all, except the number of plants, which are slated for harvest. In this way, there is a constant year-round pruning and harvesting. For example, consider a hectare of land with 1,000 banana mats, if the variety planted produces 1.5 bunches per mat per year, the total yield would be 1,500 bunches per year. If it were decided that the harvesting interval should be every 10 days, there would be 36 harvests, or cuttings, during the year. At each of these 36 harvests, approximately 42 bunches would be cut, and the farmer would not have an over-supply during the year.

The pruner allows 40 to 42 suckers of the same age to develop in scattered locations in a hectare. Pruning is done usually at 10 to 14 days intervals. An experienced pruner maintains the mat within a one-meter square of its original planting and retains uniform shading and cultivation in the field. Pruning banana plants is called suckering. There are several ways of doing this. We shall deal here with only one way of pruning. The offshoot that you planted is called the parent plant. Four months after planting, cut away all the suckers that have sprouted except one. Cut the suckers off at ground level or below the surface of the ground. Keep the best sucker, the one that is best placed. The plantation is laid out in rows, so that if the suckers are in the same line, the plantation rows are unchanged. Four months after this first suckering, the parent plant is 8 months old and the one remaining sucker (daughter sucker) is 4 months old. Once again, cut off all the other suckers by maintaining one extra sucker (grand daughter) to the previous one.

About 10 months after planting (taking Poyo bananas as an example), the parent plant produces fruits. Harvest these fruits, and cut down the parent plant. The first generation sucker is now 6 months old and the second generation is 2 months old. You can use a machete or an axe to cut out the suckers that you do not want to keep and then leave another sucker again, every time 3 suckers including the fruiting sucker are allowed to maintain. In addition, it is very important to avoid old dried leaves in order to minimize disease incidence and damage and to allow sufficient sunshine

penetration. Furthermore, during flowering it will be vital to reduce the leaves, by leaving 6 to 8 leaves in order to increase the fruit weight.

Supporting the plant from falling over

Banana is usually susceptible to wind and may fall down. There are two main reasons for the falling over of banana plants, even during low velocity of winds. These are: (1) high water table, and (2) root and rhizome injury, (3) the stem attachment with the soil is not strong enough and (4) as a result of heavy suckers.

In poorly drained soils, rhizomes grow out of the soil and only lateral shallow roots support the plant. At times, even without the slight pressure of a low velocity wind, the plant falls over. Nematodes, such as *Radopholus similis* and *Pratylenchus coffeae*, at times completely destroy the root system. The rhizome keeps growing out of the soil and sending roots down into the soil. A light wind usually topples these nematode infested plants. The banana root borer (*Cosmopolites sordidus*) can tunnel through the rhizome. When large numbers of borers infest a plantation, their damage to the rhizomes causes toppling of the plants. The doubling of the stems occurs during moderate winds of 15 to 30 kilometers per hour. To prevent this loss, plants are either propped or made steady with guys. In propping, two bamboo poles support the leaning stem, while in guying; the neck of one plant is tied up with a rope to the base of the other plant. Guying is the most effective method of supporting banana plants. The fruit of banana plants is very heavy. The plant bends under the weight, and the wind may blow it down. You must prevent it from falling. To do this, cut thick bamboos about 3 metres long. Tie two bamboos together and put the bamboos in place, when the flowers have appeared and turned down to the earth. Then the bamboos hold up the banana plant.

Supporting the plant from falling over

Banana is usually susceptible to wind and may fall down. There are two main reasons for the falling over of banana plants, even during low velocity of winds. These are: (1) high water table, and (2) root and rhizome injury, (3) the stem attachment with the soil is not strong enough and (4) as a result of heavy suckers.

In poorly drained soils, rhizomes grow out of the soil and only lateral shallow roots support the plant. At times, even without the slight pressure of a low velocity wind, the plant falls over. Nematodes, such as *Radopholus similis* and *Pratylenchus coffeae*, at times completely destroy the root system. The rhizome keeps growing out of the soil and sending roots down into the soil. A light wind usually topples these nematode infested plants. The banana root borer (*Cosmopolites sordidus*) can tunnel through the rhizome. When large numbers of borers infest a plantation, their damage to the rhizomes causes toppling of the plants. The doubling of the stems occurs during moderate winds of 15 to 30 kilometers per hour. To prevent this loss, plants are either propped or made steady with guys. In propping, two bamboo poles support the leaning stem, while in guying; the neck of one plant is tied up with a rope to the base of the other plant. Guying is the most effective method of supporting banana plants. The fruit of banana plants is very heavy. The plant bends under the weight, and the wind may blow it down. You must prevent it from falling. To do this, cut thick bamboos about 3 metres long. Tie two bamboos together and put the bamboos in place, when the flowers have appeared and turned down to the earth. Then the bamboos hold up the banana plant.

CROP PEST CONTROL

Disease control

In the tropics, bacterial wilt and Bunchy Top virus are the most important diseases that may cause extensive damage. A number of fruit-blemishing diseases can also cause reduction in fruit quality.

Insect pest control: Bananas are attacked by a wide range of insect pests which include banana root borers, red rust thrips, weevil, scales, bag worms, Chalcid wasps, peel-feeding caterpillars and many other insects as well as nematodes.

• Banana weevil

Banana weevil /*cosmopolites sordidus*/ is one of the most serious insect pests that attack banana. The larvae feed, tunnel and develop in the plant corm. This weakens the plant and predisposes it to wind damage. This insect makes holes in the base of the banana plant and lays its eggs in these holes. The eggs turn into little weevils. They eat out the heart of the banana plant. You do not see the weevils, but if the fruit bunch does not develop, or if the bunch is small and badly shaped, there may be weevils inside. To find out if there are weevils in the plantation, cut pieces of the plant's apparent trunk lengthwise. Put two pieces on the ground near each plant facing downward. Look every day at these pieces. If there are weevils in the plantation, they will hide under the pieces of "trunk" and adult weevils can then be collected every 48 hours.

Control methods: Before planting, dip the suckers in lukewarm water, or in water mixed with Némagon, if there are eelworms in the plantation, put Némagon in the soil and for the control of banana weevils, it is recommended to use 25 to 30 g of BHC.

Other pests

There are other pests that attack bananas such as thrips, aphids, scale insects, etc. These insect-pests are controlled using BHC, Aldrin or Dieldrin. In addition to insect pests banana is attacked by nematodes of which the burrowing nematode /*Radopholus similis*/ is a dangerous endoparasitic, which destroys feeder roots and reduce yield significantly. Root knot nematode also attacks banana. Control is possible by rotation at least two- three years, pre- planting fumigation and by treatment of propagating material by placing the bases in hot water for 10- 20 minutes, or dipping with non- phytotoxic nematocides.

Harvesting

Banana varieties vary greatly in their rate of growth. Generally, the diploid varieties grow much faster than triploid varieties. A banana will flower and produce fruit within 6- 18 months after planting. The fruiting stalk is harvested when the fruits are still green but after the ridges have begun to become rounded and the top most hands have become light green. The quality of fruit allowed on the plant is usually lower than that ripened off the plant, due to fruit splitting and lower sugar content.

The duration between the emergence of a bunch (shooting) and its harvest is an important factor in the marketability of the product. This duration depends on the variety and seasonal temperatures. After the bunch emerges, folds down, and all hands are exposed, it requires 60 to 70 days before the fruit is ready for harvest. Bananas must not ripen on the plant. For local markets, the bunch should be harvested as soon as the fruits are full or round. For more distant markets, they should be harvested earlier when more angular. The bunch of fruits finishes ripening tied to a rope, in the shade. If the bunch ripens on the plant, the bananas split and become mealy. Bunches can be kept longer, if they are harvested unripe. Bunches are cut and sold whole, or the hands are separated, graded and packed before sale. Since banana is highly perishable fruit great care must be taken to prevent bruising during the picking and transportation operations. It is a common practice to transport banana while they are still attached to the stalk; however, as mentioned earlier, Cavendish types are often severely bruised by this treatment.



Fig. 38. A picture showing a ripen banana fruits and banana plant

Yield

A well-cared-for plantation has a big output. The third harvest on any one plantation is the biggest, of all. From the fourth harvest, the output begins to decline and after five years a plantation is recommended to be changed with the new one. The yield of a plantation may vary between 30 and 50 tons per hectare. In African condition, on average 23 to 34 tones/ha is a common output.

REFERENCES / BIBLIOGRAPHIES

- A.M Michael. Irrigation theory and practice. Vikas publ. house, 1992, New Delhi.
- A. Phocaides. Pressurized irrigation techniques /provisional draft/, FAO of the United Nations.
1999, Rome, Italy.
- Ann Stroud. Weed management in Ethiopia, an extension and training manual, FAO, TCP.
1989, Rome, Italy.
- Awulachew, S.B.; Merrey, D.J.; Kamara, A.B.; Van koppen, B.; Penning de Vries, F.; Boelee, E.; Makombe, G. Experiences and opportunities for promoting Small- Scale /Micro- irrigation and Rainwater Harvesting for food Security in Ethiopia, 2005, Addis Ababa, Ethiopia
- Dilip Kumar Majumdar. Irrigation water management, principles and practices,
2000 New Delhi.
- Dooranbos, J., and A.H, Kassem. Yield response to water. Irrigation and drainage paper No. 33, FAO, 1986 Rome, Italy.
- Doorenbos, J., and Pruitt, W.O. Guidelines for Predicting Crop Water Requirements. *Irrigation and Drainage Paper No. 24. FAO, 1977. Rome, Italy.*
- H.P. Ritzema, R>A>L Kselik, International Institute for Land Reclamation and Improvement and Fernando Chanduvi, FAO, Land and Water Development Division, Rome, 1996.
- LeRoy Salazar, Jim Tolisano, Keith Crane, Lee Wheeler, Maya ter Kuile, David Radtke Peace Corps Information Collection and Exchange, Training Manual in the selection, planning, design, operation, and management of small-scale irrigation systems T0077, *September 1994.*
- Stern, P.H. 1985. Small scale Irrigation. Intermediate Technology Publications Ltd., London, U.K., and International Irrigation Information Center, Bet Dagan, Israel.
- T.H, Jackson. A practical guide to horticulture in Ethiopia.
- U.S. Sree Ramulu. Management of water resources in agriculture. New Age International Limited, 1998, New Delhi, India.
- Irrigation agronomy manual. Ministry of Agriculture, ADD, 1990, Addis Ababa, Ethiopia.
- Guidelines for water management and irrigation development; techniques for water application, SPFS. Water Resources, Development and Management Service. 1996, FAO, Rome Italy.
- Draft report of the National Task Force on Assessment of Salt Affected Soils and Recommendations on Management Options for Sustainable Utilization. *September 2006, Addis Ababa*

Annex I

Table 35. Irrigation methods and intervals of irrigation of major irrigated crops

Crop	Irrigation methods	Irrigation intervals (days)	Remarks
Maize	Border, furrow	14- 21	
Wheat	"	7- 14	
Groundnut	Furrow	14- 21	
Onion	"	5- 7	Frequent but light irrigation, cease 30 days prior to harvesting
Potato	"	7- 10	
Sweet potato	"	7- 15	
Pepper	"	7- 10	
Tomato	"	7- 15	
Banana	Basin, furrow	7- 15	
Citrus	"	7- 20	Up to 1 yrs old 7 days interval and keep water from touching the stem
Papaya	"	10- 15	
Watermelon	"	15	
Cabbage	Furrow	7	
Cauliflower	"	7	
Lettuce	"	5- 7	
Cucumber	"	7	
Pumpkin	"	7	
Beetroot	"	7- 14	
Carrot	"	7	
Swiss chard	"	7	
Coffee	Basin, furrow	21- 30	

Source: Irrigation Agronomy Manual, Revised Version, former MoA - ADD, March 1990, Addis Ababa.

Annex II

Table 36. Planting distance and optimum plant population of major irrigated crops

Crops	Seeding rate (kg/ha)	Planting distance (cm)	Plant population	Remarks
Maize	25 - 30	25 x 75	53, 333	
Wheat	125 - 150	5 x 20	1, 000, 000	
Groundnut	60- 80	10 x 60	166, 667	Unshelled
Onion	3.5- 4 (7)*	10 x 30	333, 333	For direct sowing
Garlic	100- 150	10 x 30	333, 333	
Tomato	0.3 (3- 4)*	45 x 100	22, 222	
Potato	1500 - 2000	35 x 70	40, 816	
Sweet potato	33, 000 cuttings	40 x 100	25, 000	

Pepper	0.75- 1.0	40 x 60	41, 667	
Banana	1600 suckers	2 m x 2 m	2, 500	
Cabbage	0.35	40 x 60	41, 667	
Cauliflower	0.25	40 x 60	41, 667	
Carrot	0.5	5 x 25	800, 000	
Beetroot	12- 16	10 x 35	285, 714	
Swiss chard	0.7	25 x 40	100, 000	
Lettuce	1.7	25 x 30	133, 333	
Cucumber	2.5	50 x 60	33, 333	
Pumpkin	5.0	100 x 150	6, 667	
Watermelon	30.0	2 m x 2 m	2, 500	
Eggplant	1.0	50 x 60	33, 333	

NB: * - The numbers in parenthesis are showing seed rates for direct sowing in the permanent field.

Annex III

Table 37. Crop coefficients for different crop growth stages (kc) and seasonal ET requirements for maximum crops yields

Crop	Crop Development Stages					Total growing period	Seasonal ET (mm)
	Initial	Crop development	Mid-season	Late season	At harvest		
Banana (tropical)	0.4- 0.5	0.7- 0.85	1.0- 1.1	0.9- 1.0	0.75- 0.85	0.7- 0.8	1200- 2200
Bean (green)	0.3- 0.4	0.65- 0.75	0.95- 1.05	0.9- 0.95	0.85- 0.95	0.85- 0.9	300- 500
Cabbage	0.4- 0.5	0.7- 0.8	0.95- 1.1	0.9- 1.0	0.8- 0.95	0.7- 0.8	380- 500
Cotton	0.4- 0.5	0.7- 0.8	1.05- 1.25	0.8- 0.9	0.65- 0.7	0.8- 0.9	700- 1300
Grape	0.35- 0.55	0.6- 0.8	0.7- 0.9	0.6- 0.8	0.55- 0.7	0.55- 0.75	500- 1200
Groundnut	0.4- 0.5	0.7- 0.8	0.95- 1.1	0.75- 0.85	0.55- 0.6	0.75- 0.8	500- 700
Maize (grain)	0.3- 0.5	0.7- 0.85	1.05- 1.2	0.8- 0.95	0.55- 0.6	0.75- 0.9	500- 800
Onion (dry)	0.4- 0.6	0.7- 0.8	0.95- 1.1	0.85- 0.9	0.75- 0.85	0.8- 0.9	350- 550
Pepper (fresh)	0.3- 0.4	0.6- 0.75	0.95- 1.1	0.85- 1.0	0.8- 0.9	0.7- 0.8	600- 900
Potato	0.4- 0.5	0.7- 0.8	1.05- 1.2	0.85- 0.95	0.7- 0.75	0.75- 0.9	500- 700
Rice	1.1- 1.15	1.1- 1.5	1.1- 1.3	0.95- 1.05	0.95- 1.05	1.05- 1.2	350- 700
Sorghum	0.3- 0.4	0.7- 0.8	1.0- 1.15	0.75- 0.8	0.5- 0.55	0.75- 0.85	450- 650
Soybean	0.3- 0.4	0.7- 0.8	1.0- 1.15	0.7- 0.8	0.4- 0.5	0.75- 0.9	na
Sugarcane	0.4- 0.5	0.7- 1.0	0.7- 1.0	0.75- 0.8	0.5- 0.6	0.85- 1.05	1500- 2500
Tomato	0.4- 0.5	0.7- 0.8	1.05- 1.25	0.8- 0.95	0.6- 0.65	0.75- 0.9	400- 600
Watermelon	0.4- 0.5	0.7- 0.8	0.95- 1.05	0.8- 0.9	0.65- 0.75	0.75- 0.85	400- 600
Wheat	0.3- 0.4	0.7- 0.8	1.05- 1.2	0.65- 0.75	0.2- 0.25	0.8- 0.9	450- 650
Citrus (no weed control)						0.85- 0.9	900- 1200

Note: First figure under high humidity (RH min > 70%) and low wind (U < 5m/sec)

Second figure: Under low humidity (RH min < 20%) and strong wind (U > 5m/sec).

Source: Dooranbos, J., and A.H, Kassem. Yield response to water. Irrigation and drainage paper No. 33, FAO crop coefficients, (modified).

Annex IV

Table 38. Approximate duration of growth stages for various field crops

Crop	Total growing period	Initial stage	Crop development stage	Mid- season stage	Late season stage
Barley /wheat	120- 150	15	25- 30	50- 65	30- 40
Bean /green	75- 90	15- 20	25- 30	25- 30	10
Bean /dry	95- 110	15- 20	25- 30	35- 40	20
Cabbage	120- 140	20- 25	25- 30	60- 65	15- 20
Carrot	100- 150	20- 25	30- 35	30- 70	20
Cotton	180- 195	30	50	55- 65	45- 50
Cucumber	105- 130	20- 25	30- 35	40- 50	15- 20
Eggplant	130- 140	30	40	40- 45	20- 25
Lentil	150- 170	20- 25	30- 35	60- 70	40
Lettuce	75- 140	20- 35	30- 50	15- 40	10
Maize /grain	125- 180	20- 30	35- 50	40- 60	30- 40
Melon	120- 160	25- 30	35- 45	40- 65	20
Onion /dry	150- 210	15- 20	25- 35	70- 110	40- 45
Groundnut	130- 140	25- 30	35- 40	45	25
Pea	90- 100	15- 20	25- 30	35	15
Pepper	120- 210	25- 30	35- 40	40- 110	20- 30
Potato	105- 145	25- 30	30- 35	30- 50	20- 30
Sorghum	120- 150	20	30- 35	40- 45	30
Soybean	135- 150	20	30	60- 70	25- 30
Sunflower	125- 130	20- 25	35	45	25

NB: The sum of the four growth stages should always equal to the total growing period of each crop.

Source: Doorenbos and Pruitt 1997.

Annex V

(Tables 39- 46 to be used for calculating the ET₀ using the modified Penman method)

Table 39. Saturation vapour pressure (ea) in mbar as function of mean air temperature (T) in 0c 1/

Temperature, °c	0	1	2	3	4	5	6	7	8	9	10	11	12	13	14	15	16	17	18	19
ea mbar	6.1	6.6	7.1	7.6	8.1	8.7	9.3	10.0	10.7	11.5	12.3	13.1	14.0	15.0	16.1	17.0	18.2	19.4	20.6	22.0
Temperature, °c	20	21	22	23	24	25	26	27	28	29	30	31	32	33	34	35	36	37	38	39
ea mbar	23.4	24.9	26.4	28.1	29.8	31.7	33.6	35.7*	37.8*	40.1*	42.4	44.9	47.6	50.3	53.2	56.2	59.4	62.8	66.3	69.6

1/ Also actual vapour pressure (ed) can be obtained from this Table using available Temperature dew point data. Example: T dew point is 18 0c; ed = 20.6 mbar.

Source: Doorenbos, J., and A.H. Kassem. Yield response to water. Irrigation and drainage paper No. 33, FAO

Table 40. Extra- terrestrial radiation (Ra) expressed in equivalent evaporation in mm/day

Northern Hemisphere												
Jan	Feb	Mar	Apr	May	June	July	Aug	Sept	Oct	Nov	Dec	Lat
6.4	8.6	11.4	14.3	16.4	17.3	16.7	15.2	12.5	9.6	7.0	5.7	40°
6.9	9.0	11.8	14.5	16.4	17.2	16.7	15.3	12.8	10.0	7.5	6.1	38
7.4	9.4	12.1	14.7	16.4	17.2	16.7	15.4	13.1	10.6	8.0	6.6	36
7.9	9.8	12.4	14.8	16.5	17.1	16.8	15.5	13.4	10.8	8.5	7.2	34

8.3	10.2	12.8	15.0	16.5	17.0	16.8	15.6	13.6	11.2	9.0	7.8	32
8.8	10.7	13.1	15.2	16.5	17.0	16.8*	15.7	13.9	11.6	9.5	8.3	30
9.3	11.1	13.4	15.3	16.5	16.8	16.7	15.7	14.1	12.0	9.9	8.8	28
9.8	11.5	13.7	15.3	16.4	16.7	16.6	15.7	14.3	12.3	10.3	9.3	26
10.2	11.9	13.9	15.4	16.4	16.6	16.5	15.8	14.5	12.6	10.7	9.7	24
10.7	12.3	14.2	15.5	16.3	16.4	16.4	15.8	14.6	13.0	11.1	10.2	22
11.2	12.7	14.4	15.6	16.3	16.4	16.3	15.9	14.8	13.3	11.6	10.7	20
11.6	13.0	14.6	15.6	16.1	16.1	16.1	15.8	14.9	13.6	12.0	11.1	18
12.0	13.3	14.7	15.6	16.0	15.9	15.9	15.7	15.0	13.9	12.4	11.6	16
12.4	13.6	14.9	15.7	15.8	15.7	15.7	15.7	15.1	14.1	12.8	12.0	14
12.8	13.9	15.1	15.7	15.7	15.5	15.5	15.6	15.2	14.4	13.3	12.5	12
13.2	14.2	15.3	15.7	15.5	15.3	15.3	15.5	15.3	14.7	13.6	12.9	10
13.6	14.5	15.3	15.6	15.3	15.0	15.1	15.4	15.3	14.8	13.9	13.3	8
13.9	14.8	15.4	15.4	15.1	14.7	14.9	15.2	15.3	15.0	14.2	13.7	6
14.3	15.0	15.5	15.5	14.9	14.4	14.6	15.1	15.3	15.1	14.5	14.1	4
14.7	15.3	15.6	15.3	14.6	14.2	14.3	14.9	15.3	15.3	14.8	14.4	2
15.0	15.5	15.7	15.3	14.4	13.9	14.1	14.8	15.3	15.4	15.1	14.8	0

Source: Dooranbos, J., and A.H, Kassem. Yield response to water. Irrigation and drainage paper No. 33, FAO

Table 41. Mean daily duration of maximum possible sunshine hours (N) for different months and latitudes

Northern latitudes	Jan	Feb	Mar	Apr	May	June	July	Aug	Sept	Oct	Nov	Dec
Southern latitudes	July	Aug	Sept	Oct	Nov	Dec	Jan	Feb	Mar	Apr	May	June
40	9.6	10.7	11.9	13.3	14.4	15.0	14.7	13.7	12.5	11.2	10.0	9.3
35	10.1	11.0	11.9	13.1	14.0	14.5	14.3	13.5	12.4	11.3	10.3	9.8
30	10.4	11.1	12.0	12.9	13.6	14.0	13.9*	13.2	12.4	11.5	10.6	10.2
25	10.7	11.3	12.0	12.7	13.3	13.7	13.5	13.0	12.3	11.6	10.9	10.6
20	11.0	11.5	12.0	12.6	13.1	13.3	13.2	12.8	12.3	11.7	11.2	10.9
15	11.3	11.6	12.0	12.5	12.8	13.0	12.9	12.6	12.2	11.8	11.4	11.2
10	11.6	11.8	12.0	12.3	12.6	12.7	12.6	12.4	12.1	11.8	11.6	11.5
5	11.8	11.9	12.0	12.2	12.3	12.4	12.3	12.3	12.1	12.0	11.9	11.8
0	12.0	12.0	12.0	12.0	12.0	12.0	12.0	12.0	12.0	12.0	12.0	12.0

Source: Dooranbos, J., and A.H, Kassem. Yield response to water. Irrigation and drainage paper No. 33, FAO

Table 42. Effect of temperature f(T) on longwave radiation (Rnl)

T °C	0	2	4	6	8	10	12	14	16	18	20	22	24	26	28	30	32	34	36
$f(T) = \delta T k^4$	11.0	11.4	11.7	12.0	12.4	12.7	13.1	13.5	13.8	14.2	14.6	15.0	15.4	15.9	16.3*	16.7	17.2	17.7	18.1

Source: Dooranbos, J., and A.H, Kassem. Yield response to water. Irrigation and drainage paper No. 33, FAO

Table 43. Effect of vapour pressure f(ed) on longwave radiation (Rnl)

ed mbar	6	8	10	12	14	16	18	20	22	24	26	28	30	32	34	36	38	40
$f(ed) = 0.34 - 0.044\sqrt{ed}$	0.23	0.22	0.20	0.19	0.18	0.16	0.15	0.14	0.13*	0.12	0.12	0.11	0.10	0.09	0.08	0.08	0.07	0.06

Source: Dooranbos, J., and A.H, Kassem. Yield response to water. Irrigation and drainage paper No. 33, FAO

Table 44. Effect of Ratio Actual and Maximum bright sunshine hours $f(n/N)$ on longwave radiation (R_{nl})

N/N	0	0.05	0.1	0.15	0.2	0.25	0.3	0.35	0.4	0.45	0.5	0.55	0.6	0.65	0.7	0.75	0.8	0.85	0.9	0.95	1.0
$f(n/N) = 0.1 + 0.09n/N$	0.10	0.15	0.19	0.24	0.28	0.33	0.37	0.42	0.46	0.51	0.55	0.60	0.64	0.69	0.73	0.78	0.82*	0.87	0.91	0.96	1.0

Source: Dooranbos, J., and A.H, Kassem. Yield response to water. Irrigation and drainage paper No. 33, FAO Table 43. Effect of vapour pressure $f(ed)$ on longwave radiation (R_{nl})

Table 45. Values of weighting factor (W) for the effect of radiation on E_{To} at different temperatures and altitudes

Temperature, °C	2	4	6	8	10	12	14	16	18	20	22	24	26	28	30	32	34	36	38	40	
W at altitude m																					
0	0.43	0.46	0.49	0.52	0.55	0.58	0.61	0.64	0.66	0.69	0.71	0.73	0.75	0.77*	0.78	0.80	0.82	0.83	0.84	0.85	
500	0.45	0.48	0.51	0.54	0.57	0.60	0.62	0.65	0.67	0.70	0.72	0.74	0.76	0.78	0.79	0.81	0.82	0.84	0.85	0.86	
1000	0.46	0.49	0.52	0.55	0.58	0.61	0.64	0.66	0.69	0.71	0.73	0.75	0.77	0.79	0.80	0.82	0.83	0.85	0.86	0.87	
2000	0.49	0.52	0.55	0.58	0.61	0.64	0.66	0.69	0.71	0.73	0.75	0.77	0.79	0.81	0.82	0.84	0.85	0.86	0.87	0.88	
3000	0.52	0.55	0.58	0.61	0.64	0.66	0.69	0.71	0.73	0.75	0.77	0.79	0.81	0.82	0.84	0.85	0.86	0.88	0.88	0.89	

Source: Dooranbos, J., and A.H, Kassem. Yield response to water. Irrigation and drainage paper No. 33, FAO

Table 46. Adjustment factor (c) in presented Penman Equation

Rs mm/day	RHmax = 30 %				RHmax = 60 %				RHmax = 90 %			
	3	6	9	12	3	6	9	12	3	6	9	12
Uday m/sec	Uday/Unight = 4.0											
0	0.86	0.90	1.00	1.00	0.96	0.98	1.05	1.05	1.02	1.06	1.10	1.10
3	0.79	0.84	0.92	0.97	0.92	1.00	1.11	1.19	0.99	1.10	1.27	1.32
6	0.68	0.77	0.87	0.93	0.85	0.96	1.11	1.19	0.94	1.10	1.26	1.33
9	0.55	0.65	0.78	0.90	0.76	0.88	1.02	1.14	0.88	1.01	1.16	1.27
	Uday/Unight = 3.0											
0	0.86	0.90	1.00	1.00	0.96	0.98	1.05	1.05	1.02	1.06	1.10	1.10
3	0.76	0.81	0.88	0.94	0.87	0.96	1.06	1.12	0.94	1.04	1.18	1.28
6	0.61	0.68	0.81	0.88	0.77	0.88	1.02	1.10	0.86	1.01	1.15	1.22
9	0.46	0.56	0.72	0.82	0.67	0.79	0.88	1.05	0.78	0.92	1.06	1.18
	Uday/Unight = 2.0											
0	0.86	0.90	1.00	1.00	0.96	0.98	1.05	1.05	1.02	1.06	1.10	1.10
3	0.69	0.76	0.85	0.92	0.83	0.91	0.99*	1.05*	0.89	0.98	1.10*	1.14*
6	0.53	0.61	0.74	0.84	0.70	0.80	0.94	1.02	0.79	0.92	1.05	1.12
9	0.37	0.48	0.65	0.76	0.59	0.70	0.84	0.95	0.71	0.81	0.96	1.06
	Uday/Unight = 1.0											
0	0.86	0.90	1.00	1.00	0.96	0.98	1.05	1.05	1.02	1.06	1.10	1.10
3	0.64	0.71	0.82	0.89	0.78	0.86	0.94*	0.99*	0.85	0.92	1.01*	1.05*
6	0.43	0.53	0.68	0.79	0.62	0.70	0.84	0.93	0.72	0.82	0.95	1.00
9	0.27	0.41	0.59	0.70	0.50	0.60	0.75	0.87	0.62	0.72	0.87	0.96

Source: Dooranbos, J., and A.H, Kassem. Yield response to water. Irrigation and drainage paper No. 33, FAO

Annex VI

Table 47. Pan coefficient (k_{pan}) for class-A pan for different groundcover and level of mean relative humidity and 24-hour windrun

RHmean %	Pan placed in short green cropped area				Pan placed in dry fallow area			
	Windward side distance of green crop m	Low < 40	Med. 40 - 70	High > 70	Windward side distance of green crop m	Low < 40	Med. 40 - 70	High > 70
Light < 175	1	0.55	0.65	0.75	1	0.70	0.80	0.85
	10	0.65	0.75	0.85	10	0.60	0.70	0.80
	100	0.70	0.80	0.85	100	0.55	0.65	0.75
	1000	0.75	0.85	0.85	1000	0.50	0.60	0.70
Moderate 175 - 425	1	0.50	0.65	0.65	1	0.65	0.75	0.80
	10	0.60	0.70	0.75	10	0.55	0.65	0.70
	100	0.65	0.75*	0.80	100	0.50	0.60	0.65

	1000	0.70	0.80	0.80	1000	0.45	0.55	0.60
Strong 425 - 700	1	0.45	0.50	0.60	1	0.60	0.65	0.70
	10	0.55	0.60	0.65	10	0.50	0.55	0.65
	100	0.60	0.65	0.70	100	0.45	0.50	0.60
	1000	0.65	0.70	0.75	1000	0.40	0.45	0.55
Very strong > 700	1	0.40	0.45	0.50	1	0.50	0.60	0.65
	10	0.45	0.55	0.60	10	0.45	0.50	0.55
	100	0.50	0.60	0.65	100	0.40	0.45	0.50
	1000	0.55	0.60	0.65	1000	0.35	0.40	0.45

Source: Doorenbos, J., and A.H, Kassem. Yield response to water. Irrigation and drainage paper No. 33, FAO

Annex VII

Table 48. Climatic, soil and water requirements for major irrigated crops

Crop	Total growing period (days)	Temperature requirements for growth, °C	Specific climatic requirements / constraints	Soil requirements	Sensitivity to salinity	Water requirements mm/growing period
Banana	300- 365	25- 30 (15- 35)	Sensitive to frost; temperature < 8 °C for longer periods causes serious damage; requires high RH and wind < 4 m/sec	Deep, well- drained loam without stagnant water; pH= 5- 7	Moderately sensitive	1200- 2200
Bean	fresh: 60- 90 dry: 90- 120	15- 20 (10- 27)	Sensitive to frost; excessive rain, hot weather	Deep, friable soil; well- drained and aerated; optimum pH= 5.6- 6.0	Sensitive	300- 500
Cabbage	100- 150	15- 20 (10- 24)	Short periods of frost (-6 to -10 °C) are not harmful; opt. RH = 60- 90 %	Well- drained; opt. pH = 6.0- 6.5	Moderately sensitive	380- 500
Citrus	240- 365	23- 30 (13- 35)	Sensitive to frost (dormant trees less), strong wind, high humidity; cool winter or short dry period preferred	Deep, well- aerated, light to medium- textured soils, free from stagnant water; pH = 5- 8	Sensitive	900- 1200
Cotton	150- 180	20- 30 (16- 35)	Sensitive to frost, strong or cold wind; temp. req. for boll development: 27- 32°C (18- 38); dry ripening period required	Deep, medium to heavy- textured soils; pH = 5.5- 8.0 with opt. pH = 7.0- 8.0	Tolerant	700- 1300
Grape	180- 270	20- 25 (15- 30)	Resistant to frost during dormancy, but sensitive during growth; long, warm to hot, dry summer and cool winter preferred	Well- drained, light soils are preferred	Moderately sensitive	500- 1200
Ground- nut	90- 140	22- 28 (18- 33)	Sensitive to frost; for germination temp. >20 °C	Well- drained, friable, medium- textured soil with loose top soil; pH = 5.5- 7.0	Moderately sensitive	500- 700
Maize	100- 140+	24- 30 (15- 35)	Sensitive to frost; for germination temp. >10 °C; cool temp. causes problem of ripening	Well- drained and aerated soils with deep water table and without water- logging; opt. pH = 5.0- 7.0	Moderately sensitive	500- 800
Onion	100- 140 (+ 30- 35 in nursery)	15- 20 (10- 25)	Tolerant to frost; low temp. (< 14 - 16 °C) required for flower initiation, no extreme temp. or excessive rain	Medium- textured soil; pH = 6.0- 7.0	Sensitive	350- 550
Pea	fresh: 65- 100 dry: 85- 120	15- 18 (10- 23)	Slight frost tolerant when young	Well- drained and aerated soils; pH = 5.5- 6.5	Sensitive	350- 500
Pepper	120- 150	18- 23 (15- 27)	Sensitive to frost	Light to Medium- textured soils; pH = 5.5- 7.0	Moderately sensitive	600- 900 (1250)
Potato	100- 150	15- 20 (10- 25)	Sensitive to frost; night temp. < 15 °C required for good tuber initiation	Well- drained, aerated and porous soils; pH = 5.0- 6.0	Moderately sensitive	500- 700
Rice	90- 150	22- 30 (18- 35)	Sensitive to frost; cool temperature causes head sterility; small difference in day and night temperature is preferred	Heavy soils preferred for percolation losses, high tolerance to O ₂ deficit; pH = 5.5- 6.0	Moderately sensitive	350- 700

Sorghum	100- 140+	24- 30 (15- 35)	Sensitive to frost; for germination temp. >10°C; cool temperature causes head sterility	Light to medium /heavy soils relatively tolerant to periodic waterlogging; pH = 6- 8	Moderately tolerant	450- 650
Soy-bean	100- 130	20- 25 (18- 30)	Sensitive to frost; for some variation of temp. > 24°C required for flowering	Wide range of soil except sandy, well-drained; pH = 6- 6.5	Moderately tolerant	450- 700
Sugarcane	270- 365	22- 30 (15- 35)	Sensitive to frost; during ripening cool temperature (10- 20°C), dry sunny weather is required	Deep, well aerated with ground water deeper than 1.5- 2.0 m but relatively tolerant to periodic high water tables and O ₂ deficit; pH = 5- 8.5; opt. pH = 6.5	Moderately sensitive	1500- 2500
Sun-flower	90- 130	18- 25 (15- 30)	Sensitive to frost	Fairly deep soils; pH = 6- 7.5	Moderately tolerant	600- 1000
Tobacco	90- 120 (+40- 60 in nursery)	20- 30 (15- 35)	Sensitive to frost	Quality of leaf depends on soil texture; pH = 5- 6.5	Sensitive	400- 600
Tomato	90- 140 (+25- 35 in nursery)	18- 25 (15- 28)	Sensitive to frost; high RH, strong wind; optimum night temperature 10- 20°C	Light loam, well-drained without waterlogging; pH = 5- 7	Moderately sensitive	400- 600
Water-melon	80- 110	22- 30 (18- 35)	Sensitive to frost	Sandy loam is preferred; pH = 5.8- 7.2	Moderately sensitive	400- 600
Wheat	100- 130	15- 20 (10- 25)	Sensitive to frost; require a cold weather for flowering during early growth; dry period required for ripening	Medium- texture is preferred; relatively tolerant to high water table; pH = 6- 8	Moderately tolerant	450- 650

Source: Doorenbos, J., and A.H, Kassem. Yield response to water. Irrigation and drainage paper No. 33, FAO, Rome 1986

Annex VIII

Table 49. Nutrient composition of vegetable crops (content of protein, vitamins and minerals) per 100 g edible portion

Type of produce	Water content (%)	Dry matter (g)	Energy (Kcal)	Protein (g)	Carbohydrate (g)	Fat (g)	Phosphorus (mg)	Ca (mg)	Fe (mg)	Thiamine (mg)	Riboflavin (mg)	Niacin (mg)	Ascorbic acid (mg)
Tomato (raw)	92.5	7.5	30.7	1.3	4.8			9	0.9	0.06	0.05	0.5	29
Tomato (boiled)	94.4	5.6	20.5	1.0	3.9			7	0.5	0.08	0.01	-	5.0
Pepper, hot (av.)	88.1	11.9	46.5	1.7	8.8	0.5	38	15	1.5	0.07	0.06	1.0	100.0
Cucumber (raw)	96.6	4.4	12.1	0.6	2.2	0.1	20	8.0	-	0.03	0.01	-	8.0
Pumpkin	90.75	9.25	38.05	1.5	6.95	0.15	39	31	1.85	0.03	0.065	0.35	8.0
Swiss chard (raw)	91.5	8.5	27.6	2.2	3.8	0.4	41	85	3.6	0.11	0.57	0.6	18.0
Carrots (av.)	90.2	9.8	34.9	1.0	7.0	0.3	26.5	31	0.95	-	-	0.5	-
Cauliflower (av.)	92.7	7.3	25.5	1.85	3.8	0.1	31.5	33.5	0.8	0.03	0.03	-	6.5
Lettuce (raw)	95.5	4.5	15.4	1.0	2.4	0.2	31	22	1.6	0.08	0.18	-	5.0
Cabbage (av.)	94.0	6.0	22.0	1.0	4.3	0.1	33	43	0.75	-	-	-	-
Onion (boiled)	78.4	21.6	92.6	2.3	20.4	0.2	67	71	3.3	0.04	0.02	-	6.0
Sweet potato (boiled)	65.5	34.4	134	0.5	32.6	0.2	54	35	0.9	-	-	0.4	-
Potato (Boiled & Roasted)	65	35	85	1.75	32	0.2	46	8	1.3	-	-	1.8	-
Celery (av.)	85.0	15.0	48.5	3.6	7.5	0.45	66	325	5.75	0.07	0.4	0.5	16.0

Source: Ethiopian Nutrition Institute.

NB: - Data not available

Annex IX

Table 50. Evapotranspiration rate in some parts of Ethiopia

	Av. ET_0 , mm/day	Altitude, m	Av. annual temp., °C	Remark
Adaba	4.0	2485	15	
Ambo	4.6	2080	18	
Arba Minch	4.8	1290	21	
Assela	3.9	2450	14	
Awash	5.1	916	26	
Butajira	4.0	2100	16	
Debre Zeit	4.4	1900	19	
Diksis	4.0	2600	16	
Dire Dawa	6.7	1210	25	
Dodola	3.3	2540	24	Low ET_0
Gambella	5.3	480	28	
Gewane	5.5	625	25	
Girawa	4.8	2250	15	
Goba	3.4	2700	13	
Godie	6.5	320	29	
Guder	4.5	2002	17	
Harar	4.3	1856	19	
Humera	6.2	550	29	
Hosaina	4.1	2290	17	
Konso	5.7	1460	22	
Langano	4.6	1600	20	
Melka Worer	6.8	737	26	
Metema	7.1	803	28	High ET_0
Munissa	3.7	2250	13	
Nazreth	4.6	1622	20	
Olgolcho	4.5	1800	19	
Sodo	4.2	2020	20	
Ticho	3.6	2800	14	
Wenj	4.6	1540	21	
Zeway	4.4	1640	19	

NB: Average value of ET_0 is calculated using the modified Penman method (FAO – AGLW)

Source: National Meteorological Service Agency (based on 15 years data collected)

Annex X

Table 51. Root depth of major irrigated crops

Crop type	Root depth of crops (m)	Soil Types		
		Shallow and /or sandy soil	Loamy soil	Clayey soil
Shallow rooted crops	0.3- 0.6	15	20	30
Potato	0.4- 0.6			
Onion	0.3- 0.5			
Lettuce	0.3- 0.5			
Cabbage	-			
Spinach	-			
Ananas	0.5- 0.6			
Crops with medium root depth	0.5- 1.0	30	40	50
Banana	0.5- 0.9			
Pepper	0.5- 1.0			
Tomato	0.7- 1.5			

Groundnut	0.5- 1.0			
Field peas	-			
Beetroot	-			
Carrot	0.5- 1.0			
Haricot bean	-			
Sunflower	-			
Pumpkin	-			
Tobacco	-			
Deep rooted crops	0.9- 1.5	40	60	70
Maize	1.0- 1.7			
Sorghum	1.0- 2.0			
Wheat	1.0- 1.5?			
Barley	1.0- 1.5			
Emmer wheat	1.0- 1.5?			
Cotton	1.0- 1.7			
Sweet potato	1.0- 1.5			
Orange	1.2- 1.5			
Other citrus spp	1.2- 1.5			
Lemon	1.2- 1.5?			
Water melon	1.0- 1.5			
Sugar cane	1.2- 2.0			
Linseed	-			
Grape	1.0- 2.0			
Safflower	1.0- 2.0			

Source: Agriculture and Irrigation Manual, former Ministry of Agriculture, ADD, Dec. 1985 E.C (with modification)

Annex XI

Table 52. Fertilizer recommendations for major cereal crops, kg/ha in the form of N - P₂O₅ - K₂O (under rainfed condition)

Criterion	Shoa			Shoa /Arsi /Bale	Gojam		Arsi /Bale	Across the country				
	Teff	Wheat	Maize	Barley	Teff	Maize	Wheat	Teff	Wheat	Barley	Maize	Sorghum
Vertisols	80-60-0	75-50-0	-	80-80-20	80-75-0	-	55-60-0	80-60-0	70-55-0	45-45-0	-	-
Nitisols	50-55-0	80-80-0	75-80-0	60-70-30	45-60-0	75-80-0	80-80-30	40-55-0	70-65-0	60-65-30	75-80-0	-
Cambisols	50-50-0	80-70-0	50-50-20	-	50-50-0	50-50-20	55-35-0	50-50-0	55-45-0	-	50-50-20	-
Luvisols	-	-	-	-	-	-	-	45-50-0	50-70-0	-	-	-
Andosols	45-55-0	65-60-0	50-55-0	-	-	50-55-0	-	45-50-0	50-45-0	-	50-55-0	-
Black soils	80-65-0	75-45-0	80-80-0	60-70-0	80-60-0	80-80-0	80-80-0	75-60-0	75-55-0	-	65-55-0	40-30-0
Grey soils	40-55-0	80-80-0	50-55-0	-	-	50-55-0	-	45-50-0	50-45-0	70-70-0	55-55-0	-
Red soils	50-55-0	80-75-0	80-80-20	50-65-30	45-55-0	80-80-20	55-80-30	40-50-0	55-60-0	55-65-30	65-75-20	35-75-0
Brown soils	50-50-0	80-80-0	55-50-0	55-60-30	50-60-0	55-50-0	60-60-0	50-55-0	75-70-0	55-60-30	55-50-0	-

Source: Gebre Kidan, Girma. Review of adaptive trial activities in soil fertility management. April 1998, Addis Ababa

Fertilizer calibration

The amount of fertilizers to be applied per hectare depends on the amount of nutrients needed and the fertilizer grades available. So that fertilizer calibration is important to be considered in determining the right amount of fertilizers required. The main objectives of fertilizer calibration are therefore, the following:

To determine the rate of nutrients to be applied per unit area;

To calculate the amount of commercial fertilizers that will supply the required amount of nutrients for a given area of land.

Procedures for calculation:

1. Calculate the required quantity of a straight commercial fertilizer that can supply 120 kg of N/ha. The fertilizer to be used is ammonium sulfate, $(\text{NH}_4)_2\text{SO}_4$.

Steps for calculation:

Ammonium sulfate contains 20% N that means 100 kg of commercial ammonium sulfate will supply 20 kg N.

Therefore, 120 kg N will be available from:

100 kg of AS	-	20 kg N
?	-	120 kg N

Solution: $\frac{100 \text{ kg} \times 120 \text{ kg}}{20 \text{ kg}} = 600 \text{ kg}$ of AS

20 kg

Therefore, for 1 ha of land 600 kg of commercial AS will be required to supply 120 kg N.

2. When two nutrients are to be applied simultaneously to a field by using compound fertilizers or double carriers. For instance, if N and P are to be applied by using diammonium phosphate, which contains 18 kg of N and 46 kg of P per 100 kg of the fertilizer and urea with the application rate of 50 - 50 - 0. Then calculate the amount of commercial fertilizers needed to get the required amount of nutrients per ha.

Steps for calculation:

First calculate the required quantity of DAP to provide 50 kg of P.

Given:

DAP contains 18 kg of N and 46 kg of P;

Therefore, 46 kg of P is available from 100 kg of DAP;

50 kg of P would be supplied from ?;

$$\frac{50 \text{ kg} \times 100 \text{ kg}}{46 \text{ kg}} = 108.7 \text{ kg} \sim \underline{100} \text{ kg of DAP}$$

Now find out the N available from 108.7 kg of DAP, if 100 kg of DAP has 18 kg N:

$$\frac{18 \text{ kg} \times 108.7 \text{ kg}}{100 \text{ kg}} = 19.8 \text{ kg} = \underline{20} \text{ kg N}$$

The required amount of nitrogen fertilizer to be applied per ha is 50 kg out of which 20 kg will be supplied through 108.7 kg of DAP per ha. The balance that will be required from Urea will be then:
 $50 \text{ kg} - 20 \text{ kg} = \underline{30} \text{ kg}$.

Urea contains 46 % of N and 30 kg N will be available from:

$$\frac{100 \text{ kg} \times 30 \text{ kg}}{46 \text{ kg N}} = \underline{65} \text{ kg of urea}$$

e) Therefore, 108.7 kg of DAP and 65 kg of urea will be required to provide 50 kg N and 50 kg P per ha.

3. If a fertilizer recommendation of 100 kg N and 90 kg P_2O_5 and 60 kg K_2O , commonly expressed as 100 - 90 - 60 can be converted in the following manner.

Given:

Fertilizer materials to be used: Ammonium nitrate, AN - 33.5% N; Triple superphosphate, TSP - 46% P_2O_5 and Muriate of potash, MOP - 60% K_2O

Determine that, if the first application is 50 - 90 - 60.

As 100 kg of AN contain 33.5 kg N, then 50 kg N will be available from:

$$\frac{100 \text{ kg AN} \times 50 \text{ kg N}}{33.5 \text{ kg}} = 149.5 \sim 150 \text{ kg AN}$$

As it is necessary to act in a more practical manner towards the farmer, the recommendation can be expressed in terms of bags. Accordingly, the farmer needs to buy 150 kg of AN or 3 bags of 50 kg each.

Following the same procedure for phosphate and potassium:

For phosphate: $\frac{100 \times 90}{46} = 195.65 = 200$ kg or 4 bags of TSP;

46

For potash: $\frac{100 \times 60}{60} = 100$ kg MOP or 2 bags;

60

Therefore, the farmer should use for his first application a mixture of 150 kg AN, 200 kg TSP and 100 kg MOP. For the second application, apply the remaining 50 kg as AN following the same calculation procedure explained above, i.e. 150 kg or 3 bags of 50 kg each of AN will be needed.

4. If the preceding recommendation 100 - 90 - 60 has to be given in terms of AN, DAP and MOP, then the calculation procedure takes the following manner:

First application as indicated above is 50 - 90 - 60, then;

Phosphate: $\frac{100 \times 90}{46} = 195.55$, which are virtually 200 kg of DAP /4 bags of 50 kg/

46

But DAP contains 18% of N, therefore, the amount of nitrogen in the first application:

$$\text{DAP} = \frac{200 \times 18}{100} = 36 \text{ kg N}$$

100

Therefore, 50 kg of N will be applied in the first application in the form of DAP.

Thus, a further 14 kg of N /50 - 36 = 14 kg N/ need to be applied as AN:

$$\frac{14 \times 100}{33.5} = 41.79 \text{ kg} \sim 50 \text{ kg or 1 bag.}$$

33.5

For potash, the application is: $\frac{100 \times 60}{60} = 100$ kg or 2 bags of 50 kg each

60

For the second application, the remaining 50 kg N should be applied as AN:

$$\frac{100 \times 50}{33.5} = 149.25 \text{ kg, which is virtually 150 kg or 3 bags of AN.}$$

33.5

5. How much nutrient of nitrogen and phosphorus are applied, if we used the commercial products of 130 kg of DAP and 50 kg of Urea?

Solutions:

The amount of phosphorus applied: $\frac{130 \times 46}{100} = 59.8 \text{ kg} \sim 60 \text{ kg of P}_2\text{O}_5$;

100

b) When we applied 100 kg of DAP at the same time 18 kg of N are applied together.

Then: $\frac{130 \times 18}{100} = 23.4 \text{ kg} \sim 25 \text{ kg of N}$;

100

The amount of N from 50 kg Urea: $\frac{50 \times 46}{100} = 23 \text{ kg}$;

100

Therefore, the total amount of N is equal to $23.4 + 23 = 46.4 \text{ kg N}$ and the amount of P $60 \text{ kg P}_2\text{O}_5$.

The calculation procedure is similarly, applied for other rates of recommendations and commercial fertilizers as well. 5. How much nutrient of nitrogen and phosphorus are applied, if we used the commercial products of 130 kg of DAP and 50 kg of Urea?

Solutions:

a) The amount of phosphorus applied: $\frac{130 \times 46}{100} = 59.8 \text{ kg} \sim 60 \text{ kg of P}_2\text{O}_5$;

100

b) When we applied 100 kg of DAP at the same time 18 kg of N are applied together.

Then: $\frac{130 \times 18}{100} = 23.4 \text{ kg} \sim 25 \text{ kg of N}$;

100

c) The amount of N from 50 kg Urea: $\frac{50 \times 46}{100} = 23 \text{ kg}$;

100

d) Therefore, the total amount of N is equal to $23.4 + 23 = 46.4 \text{ kg N}$ and the amount of P $60 \text{ kg P}_2\text{O}_5$.

The calculation procedure is similarly, applied for other rates of recommendations and commercial fertilizers as well.





Designed by Elias Asmare
Tel: +251911158393